



IM30-15NDS-ZW1

IM Standard

INDUCTIVE PROXIMITY SENSORS

SICK
Sensor Intelligence.



Ordering information

| Type | Part no. |
|----------------|----------|
| IM30-15NDS-ZW1 | 6020330 |

Other models and accessories → www.sick.com/IM_Standard

Illustration may differ



Detailed technical data

Features

| | |
|--|---------------------------|
| Housing | Cylindrical thread design |
| Housing | Standard design |
| Thread size | M30 x 1.5 |
| Diameter | Ø 30 mm |
| Sensing range S_n | 15 mm |
| Safe sensing range S_a | 12.15 mm |
| Installation type | Non-flush |
| Switching frequency | 150 Hz |
| Connection type | Cable, 2-wire, 2 m |
| Output function | NO |
| Electrical wiring | DC 2-wire |
| Enclosure rating | IP67 ¹⁾ |

¹⁾ According to EN 60529.

Mechanics/electronics

| | |
|--|-----------------------------------|
| Supply voltage | 10 V DC ... 30 V DC |
| Ripple | ≤ 10 % |
| Voltage drop | ≤ 2.8 V ¹⁾ |
| Time delay before availability | ≤ 50 ms |
| Hysteresis | 2 % ... 10 % |
| Reproducibility | ≤ 2 % ²⁾ ³⁾ |
| Temperature drift (of S_r) | ± 10 % |
| EMC | According to EN 60947-5-2 |

¹⁾ At I_a max.

²⁾ Supply voltage U_B and constant ambient temperature T_a .

³⁾ Of S_r .

| | |
|--|----------------------------------|
| Continuous current I_a | ≤ 100 mA |
| Off-state current | ≤ 0.8 mA |
| Minimum load current | ≥ 3 mA |
| Cable material | PVC |
| Conductor size | 0.34 mm ² |
| Short-circuit protection | ✓ |
| Reverse polarity protection | ✓ |
| Shock and vibration resistance | 30 g, 11 ms / 10 ... 55 Hz, 1 mm |
| Ambient operating temperature | -25 °C ... +70 °C |
| Housing material | Brass, Nickel-plated brass |
| Sensing face material | Plastic |
| Housing length | 60 mm |
| Thread length | 38 mm |
| Tightening torque, max. | 60 Nm |

¹⁾ At I_a max.

²⁾ Supply voltage U_B and constant ambient temperature T_a .

³⁾ Of Sr.

Reduction factors

| | |
|-----------------------------------|--|
| Note | The values are reference values which may vary |
| Stainless steel (V2A, 304) | Approx. 0.8 |
| Aluminum (Al) | Approx. 0.5 |
| Copper (Cu) | Approx. 0.45 |
| Brass (Br) | Approx. 0.55 |

Installation note

| | |
|---------------|---------------------------------------|
| Remark | Associated graphic see "Installation" |
| A | 15 mm |
| B | 45 mm |
| C | 30 mm |
| D | 45 mm |
| E | 18 mm |
| F | 120 mm |

Classifications

| | |
|---------------------|----------|
| ECLASS 5.0 | 27270101 |
| ECLASS 5.1.4 | 27270101 |
| ECLASS 6.0 | 27270101 |
| ECLASS 6.2 | 27270101 |
| ECLASS 7.0 | 27270101 |
| ECLASS 8.0 | 27270101 |
| ECLASS 8.1 | 27270101 |
| ECLASS 9.0 | 27270101 |
| ECLASS 10.0 | 27270101 |

| | |
|-----------------------|----------|
| ECLASS 11.0 | 27270101 |
| ECLASS 12.0 | 27274001 |
| ETIM 5.0 | EC002714 |
| ETIM 6.0 | EC002714 |
| ETIM 7.0 | EC002714 |
| ETIM 8.0 | EC002714 |
| UNSPSC 16.0901 | 39122230 |

Installation note

Non-flush installation

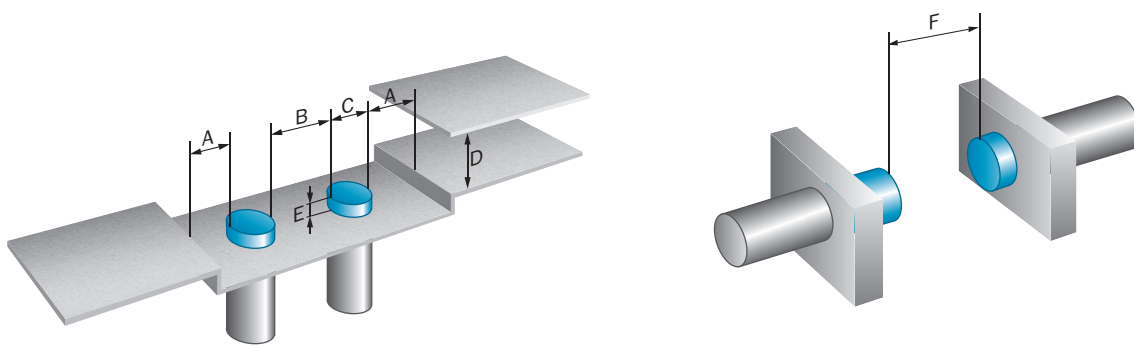

Connection type

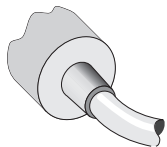

Connection diagram

Cd-012

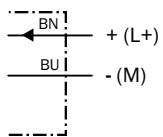

Dimensional drawing (Dimensions in mm (inch))

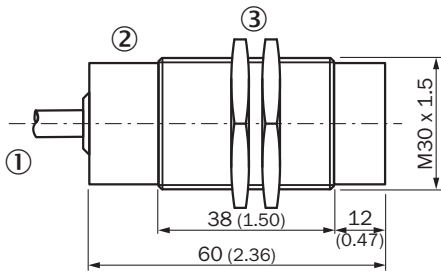

IM30, DC 2-wire, cable, non-flush



- ① Connection
- ② Display LED
- ③ Fastening nuts (2x); width across 36, metal

Recommended accessories

Other models and accessories → www.sick.com/IM_Standard

| | Brief description | Type | Part no. |
|---|---|-------------|----------|
| Universal bar clamp systems | | | |
|  | Plate N10 for universal clamp bracket, M30, Zinc plated steel (sheet), Zinc die cast (clamping bracket), Universal clamp (5322626), mounting hardware | BEF-KHS-N10 | 2062372 |
| Mounting brackets and plates | | | |
|  | Mounting plate for M30 sensors, steel, zinc coated, without mounting hardware | BEF-WG-M30 | 5321871 |
|  | Mounting bracket for M30 sensors, steel, zinc coated, without mounting hardware | BEF-WN-M30 | 5308445 |

SICK AT A GLANCE

SICK is one of the leading manufacturers of intelligent sensors and sensor solutions for industrial applications. A unique range of products and services creates the perfect basis for controlling processes securely and efficiently, protecting individuals from accidents and preventing damage to the environment.

We have extensive experience in a wide range of industries and understand their processes and requirements. With intelligent sensors, we can deliver exactly what our customers need. In application centers in Europe, Asia and North America, system solutions are tested and optimized in accordance with customer specifications. All this makes us a reliable supplier and development partner.

Comprehensive services complete our offering: SICK LifeTime Services provide support throughout the machine life cycle and ensure safety and productivity.

For us, that is “Sensor Intelligence.”

WORLDWIDE PRESENCE:

Contacts and other locations –www.sick.com