

# Getting Started

## With Altivar Process ATV600



### 1 Download The Manuals

You must have detailed information to be able to carry out the installation and commissioning.

This information can be found in the following manuals that can be downloaded on [www.schneider-electric.com](http://www.schneider-electric.com):

- The Altivar Process Installation manual ([EAV64301](#))
- The Altivar Process Programming manual ([EAV64318](#))

### DANGER

#### HAZARD OF ELECTRIC SHOCK, EXPLOSION OR ARC FLASH

- Only appropriately trained persons who are familiar with and understand the contents of this manual and all other pertinent product documentation and who have received safety training to recognize and avoid hazards involved are authorized to work on and with this drive system. Installation, adjustment, repair and maintenance must be performed by qualified personnel.
- The system integrator is responsible for compliance with all local and national electrical code requirements as well as all other applicable regulations with respect to grounding of all equipment.
- Many components of the product, including the printed circuit boards, operate with mains voltage.
- Only use properly rated, electrically insulated tools and measuring equipment.
- Do not touch unshielded components or terminals with voltage present.
- Motors can generate voltage when the shaft is rotated. Prior to performing any type of work on the drive system, block the motor shaft to prevent rotation.
- AC voltage can couple voltage to unused conductors in the motor cable. Insulate both ends of unused conductors of the motor cable.
- Do not short across the DC bus terminals or the DC bus capacitors or the braking resistor terminals.
- Before performing work on the drive system:
  - Disconnect all power, including external control power that may be present. Take into account that the circuit breaker or main switch does not de-energize all circuits.
  - Place a **Do Not Turn On** label on all power switches related to the drive system.
  - Lock all power switches in the open position.
  - Wait 15 minutes to allow the DC bus capacitors to discharge.
  - Follow the instructions given in the chapter "Verifying the Absence of Voltage" in the installation manual of the product.
- Before applying voltage to the drive system:
  - Verify that the work has been completed and that the entire installation cannot cause hazards.
  - If the mains input terminals and the motor output terminals have been grounded and short-circuited, remove the ground and the short circuits on the mains input terminals and the motor output terminals.
  - Verify proper grounding of all equipment.
  - Verify that all protective equipment such as covers, doors, grids is installed and/or closed.

**Failure to follow these instructions will result in death or serious injury.**

Electrical equipment should be installed, operated, serviced, and maintained only by qualified personnel. No responsibility is assumed by Schneider Electric for any consequences arising out of the use of this material.

### 2 Verify The Delivery Of The Drive

Unpack the drive and verify that it has not been damaged.

Damaged products or accessories may cause electric shock or unanticipated equipment operation.

### DANGER

#### ELECTRIC SHOCK OR UNANTICIPATED EQUIPMENT OPERATION

Do not use damaged products or accessories.

**Failure to follow these instructions will result in death or serious injury.**

Contact your local Schneider Electric sales office if you detect any damage whatsoever.

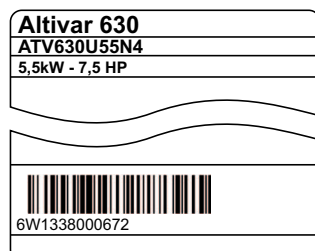

- Verify that the drive catalog number printed on the label is the same as that on the delivery note corresponding to the purchase order.
  - Write the drive Model catalog number: \_\_\_\_\_
- and Serial Number: \_\_\_\_\_

### 3 Verify The Supply Mains Compatibility

- Verify that the **supply mains** is compatible with the drive.  
 3-phase supply mains \_\_\_\_\_ Volts      Drive mains voltage \_\_\_\_\_ Volts  
 Drive range: ATV●●●●●● M3 = 200/240 V – ATV●●●●●● N4 = 380/480 V – ATV●●●●●● S6● = 600 V – ATV●●●●●● Y6 = 500/690 V

### 4 Mount The Drive Vertically

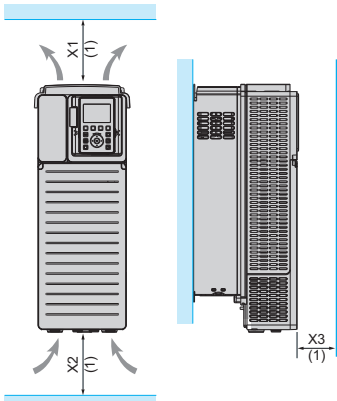

Drive	X1	X2	X3
ATV630U07●●...ATV630D90N4, ATV630U22S6X...ATV630D15S6X, ATV630●●●S6, ATV630●●●Y6, ATV650●●●●●●	≥ 100 mm (3.9 in.)	≥ 100 mm (3.9 in.)	≥ 10 mm (0.39 in.)
ATV630D55M3...ATV630D75M3, ATV630C11N4...ATV630C16N4	≥ 250 mm (10 in.)	≥ 250 mm (10 in.)	≥ 100 mm (3.9 in.)
ATV630C22N4●●...ATV630C31N4●●	≥ 200 mm (8 in.)	≥ 150 mm (5.9 in.)	≥ 10 mm (0.39 in.)

For a surrounding air temperature up to 50 °C (122 °F). For other thermal conditions, see Installation manual (EAV64301) on [www.schneider-electric.com](http://www.schneider-electric.com)

(1) Minimum value corresponding to thermal constraints

### 5 Connect The Drive: Power

- Connect the drive to ground.
- Verify circuit breaker rating or fuse rating, see SCCR annex (EAV64300).
- Verify that the nominal motor voltage is compatible with the drive voltage.  
 Nominal motor voltage \_\_\_\_\_ volts.
- Connect the drive to the motor.
- Connect the drive to the mains.

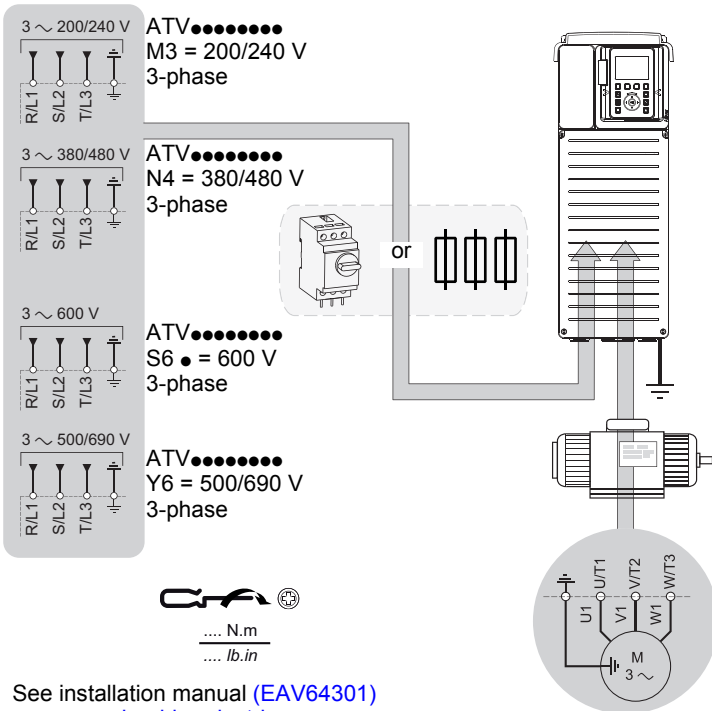

### 6 Connect The Drive: Control

- Connect the reference frequency AI1:

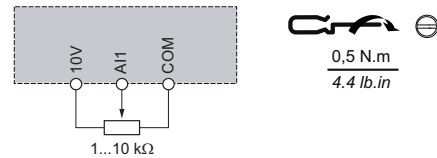

- Connect the command DI1:  
 Control command 2-wire (factory setting)

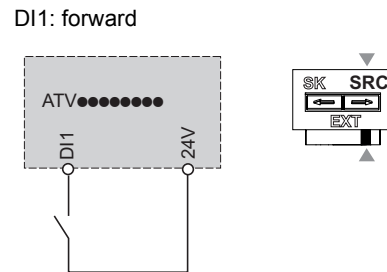

## ⚠️ DANGER

### HAZARD OF FIRE OR ELECTRIC SHOCK

Wire cross sections and tightening torques must comply with the specifications provided in the installation manual.

**Failure to follow these instructions will result in death or serious injury.**

# 7 [Simply start]

- Verify that digital input is not active (DI1, see step 6 drawing).
- Apply power to the drive.
- If requested, set the date, time, and language.

Access to [Simply start] by:



OR



## Graphic Display Terminal

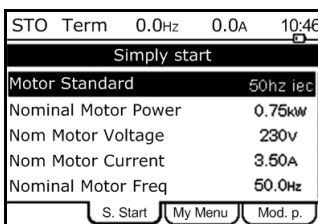
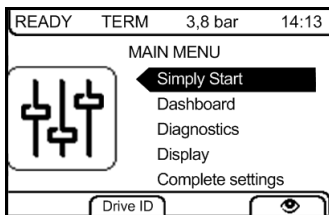

Select **[S. Start]** tab.

## Webserver Embedded

Steps to follow to access [Simply start]

1/ Connect the drive to your PC with an Ethernet cable

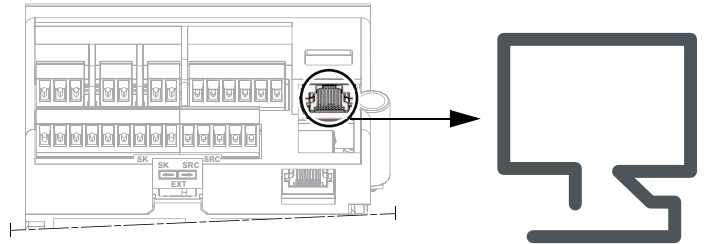

2/ Open Network Explorer on your PC.

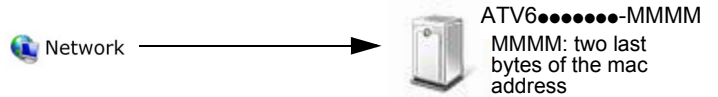

Your drive appears automatically. Right-click and select «Display device web page» to open Webserver.

Note: If the icon doesn't appear, contact your IT administrator for the firewall or antivirus configuration.

3/ On first connection, default connection IDs are:

- User Name = ADMIN
- Password, available from the Graphic Display Terminal: [\[Main Menu\]](#) → [\[My preference\]](#) → [\[Webserver\]](#)

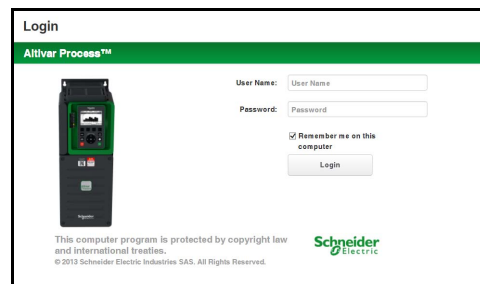

4/ Change default connection ID (User Name and Password).

5/ Access to [Simply start]  
Select My dashboard tab.

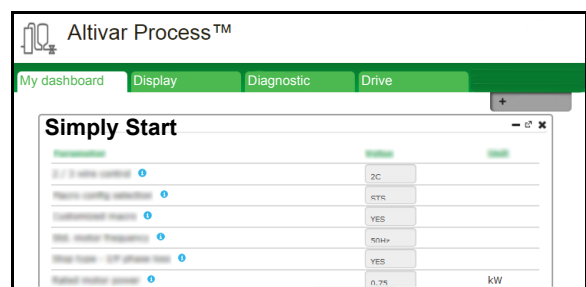

## 8 Set Motor Parameters For Asynchronous Motor

See the motor nameplate to set the following

Menu	Parameter	Factory Setting		Customer Setting
		ATV●●●●● M3 ATV●●●●● N4 ATV●●●●● Y6	ATV●●●●● S6●	
[Simply start]	[Motor Standard] <i>b F r</i> : Standard motor frequency	[50 Hz IEC] 50 (Hz)	[60 Hz IEC] 60 (Hz)	
	[Nominal Motor Power] <i>n P r</i> : Nominal motor power on motor nameplate	drive rating (kW)	drive rating (HP)	
	[Nom Motor Voltage] <i>u n S</i> : Nominal motor voltage on motor nameplate	drive rating (Vac)		
	[Nom Motor Current] <i>n I r</i> : Nominal motor current on motor nameplate	drive rating (A)		
	[Nominal Motor Freq] <i>F r S</i> : Nominal motor frequency on motor nameplate	50 (Hz)		
	[Nominal Motor Speed] <i>n S P</i> : Nominal motor speed on motor nameplate	drive rating (rpm)		
	[2/3-Wire Control] <i>E C C</i> : Command control by 2 wire or 3 wire control	2 C		
	[Max Frequency] <i>E F r</i> : Maximum motor frequency	60 (Hz)	72 (Hz)	
[Motor Th current] <i>i L H</i> : Motor thermal current on motor nameplate	drive rating (A)			

## 9 Perform A Motor [Autotuning]

### ⚠ WARNING

#### UNEXPECTED MOVEMENT

Autotuning moves the motor in order to tune the control loops.

- Only start the system if there are no persons or obstructions in the zone of operation.

**Failure to follow these instructions can result in death, serious injury, or equipment damage.**

During [Autotuning], the motor makes small movement. Noise development and oscillations of the system are normal.

Menu	Parameter
[Simply start]	[Autotuning] <i>t u n</i> : Set parameter to [Apply Autotuning] <i>y E S</i> . [Autotuning] <i>t u n</i> is done immediately.

## 10 Set Basic Parameters

Menu	Parameter	Factory Setting		Customer Setting
		ATV●●●●● M3 ATV●●●●● N4 ATV●●●●● Y6	ATV●●●●● S6●	
[Simply start]	[Acceleration] <i>R C C</i> : Acceleration time	10.0 (s)		
	[Deceleration] <i>d E C</i> : Deceleration time	10.0 (s)		
	[Low speed] <i>L S P</i> : Motor frequency at minimum reference	0 (Hz)		
	[High speed] <i>H S P</i> : Motor frequency at maximum reference	50 (Hz)	60 (Hz)	

## 11 Start The Motor

Set the [Reference frequency] with the potentiometer

