



SGS4-F108P3PS2W0C

SLG

SWITCHING AUTOMATION LIGHT GRIDS

SICK
Sensor Intelligence.



Illustration may differ



Ordering information

Type	Part no.
SGS4-F108P3PS2W0C	1216883

Other models and accessories → www.sick.com/SLG

Detailed technical data

Features

Sensor principle	Sender/receiver
Minimum detectable object (MDO)	Parallel beam, 45 mm
Beam separation	40 mm
Optical light exit	Flat
Number of beams	28
Detection height	1,080 mm
Parameterization	None
Cross beam/parallel beam	Parallel beam active
Output 1	Output 1 active, if light beam interrupted
Automatic teach	Automatic teach active
Alignment aid	With alignment aid
Muting function	Muting function deactivated

Mechanics/electronics

Light source	Infrared light
Wave length	950 nm
Supply voltage V_s	DC24 V, $\pm 20\%$
Power consumption receiver	≤ 70 mA
Ripple	$< 5 V_{pp}$
Output current $I_{max.}$	100 mA
Output load, capacitive	100 nF
Output load, inductive	1 H
Initialization time	1 s
Switching output	PNP
Inputs	Teach-in input (receiver)

¹⁾ Operating in outdoor condition only with a external protection housing.

	Test input (sender) HIGH = 10 V ... 30 V / LOW = < 5 V
Dimensions (W x H x D)	36.5 mm x 1,152.4 mm x 12.4 mm
Connection type	Cable with M8 male connector, 4-pin
Housing material	PMMA
Indication	LED
Synchronization	Optical
Enclosure rating	IP65 1)
Circuit protection	U _V connections, reverse polarity protected Output Q short-circuit protected Interference pulse suppression
Protection class	III
Weight	140 g
Pulse frequency	500 kHz
Aluminum stabilizer	With stabilizer

1) Operating in outdoor condition only with a external protection housing.

Performance

Maximum range	4 m ¹⁾
Minimum range	Parallel beam: ≥ 0 m
Operating range	3 m
Response time	Parallel beam, 19 ms

1) No reserve for environmental issue and deterioration of the diode.

Ambient data

Shock resistance	10 g / DIN EN 60068-2-29 / 16 ms
Vibration resistance	5 g, 10 Hz ... 55 Hz (IEC 68-2-6)
EMC	EN 60947-5-2
Ambient light immunity	Direct: 100,000 lx ¹⁾ Indirect: 150,000 lx
Ambient operating temperature	-25 °C ... +55 °C
Ambient temperature, storage	-25 °C ... +70 °C

1) Sunlight.

Classifications

eCl@ss 5.0	27270910
eCl@ss 5.1.4	27270910
eCl@ss 6.0	27270910
eCl@ss 6.2	27270910
eCl@ss 7.0	27270910
eCl@ss 8.0	27270910
eCl@ss 8.1	27270910
eCl@ss 9.0	27270910
eCl@ss 10.0	27270910

eCl@ss 11.0	27270910
eCl@ss 12.0	27270910
ETIM 5.0	EC002549
ETIM 6.0	EC002549
ETIM 7.0	EC002549
ETIM 8.0	EC002549
UNSPSC 16.0901	39121528

Dimensional drawing (Dimensions in mm (inch))

Sxx-Fxxxxxx2xxx

Flat, with stabilizer

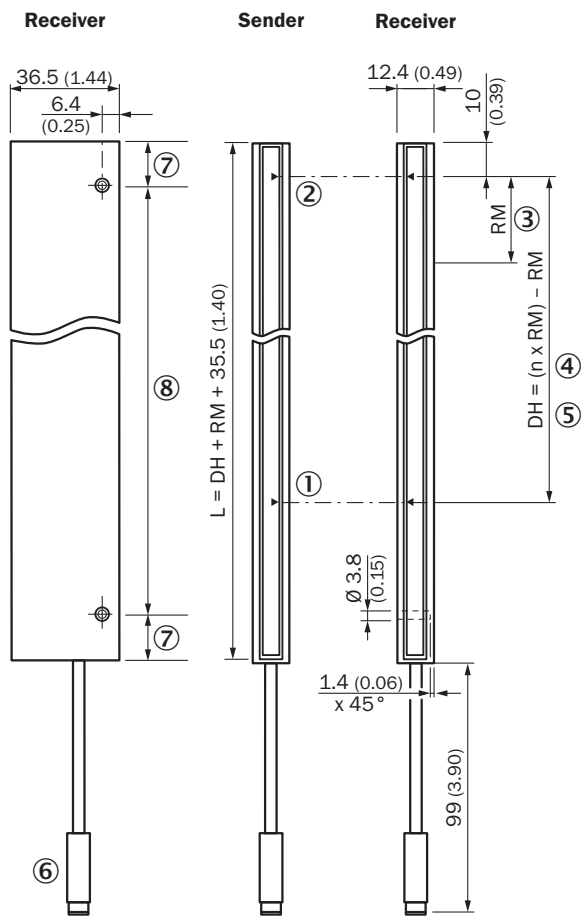

- ① First beam
- ② Last beam
- ③ Beam separation (RM)
- ④ Number of beams (n)
- ⑤ Detection height (DH)
- ⑥ Connection
- ⑦ Same distance
- ⑧ See table (hole spacing stabilizer)

Hole spacing stabilizer

Monitoring height (MH)	Number of holes	Distance between the holes	Distance first hole to the last hole
------------------------	-----------------	----------------------------	--------------------------------------

Hole spacing stabilizer			
0120	2	160	160
0280	2	320	320
0440	2	320	320
0600	3	320	640
0760	3	320	640
0920	4	320	960
1080	4	320	960
1240	5	320	1280
1400	5	320	1280

Connection type and diagram

Connection type and diagram

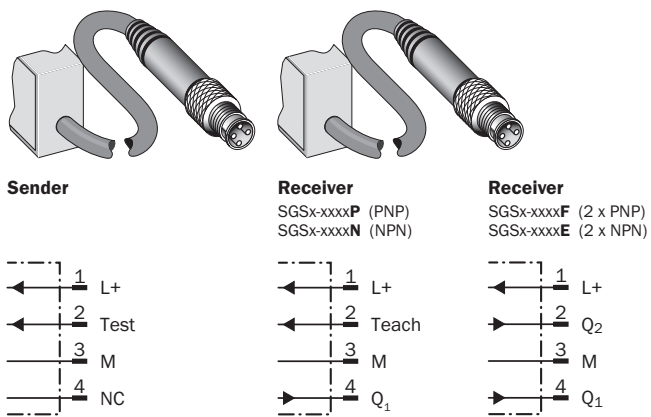

Concept of operation

Specific features

Optical synchronization

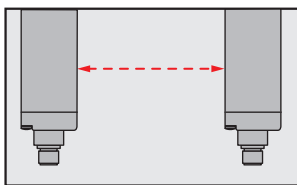

The light grid communicates via the light beams. A cable is not necessary for the optical synchronization.

Functional principle

Slim & Flat



- ① Slim model = light emission on narrow side
- ② Flat model = light emission on broad side

Recommended accessories

Other models and accessories → www.sick.com/SLG

	Brief description	Type	Part no.
Plug connectors and cables			
	Head A: female connector, M8, 4-pin, straight, A-coded Head B: Flying leads Cable: Sensor/actuator cable, PVC, unshielded, 2 m	YF8U14-020VA3XLEAX	2095888

SICK AT A GLANCE

SICK is one of the leading manufacturers of intelligent sensors and sensor solutions for industrial applications. A unique range of products and services creates the perfect basis for controlling processes securely and efficiently, protecting individuals from accidents and preventing damage to the environment.

We have extensive experience in a wide range of industries and understand their processes and requirements. With intelligent sensors, we can deliver exactly what our customers need. In application centers in Europe, Asia and North America, system solutions are tested and optimized in accordance with customer specifications. All this makes us a reliable supplier and development partner.

Comprehensive services complete our offering: SICK LifeTime Services provide support throughout the machine life cycle and ensure safety and productivity.

For us, that is “Sensor Intelligence.”

WORLDWIDE PRESENCE:

Contacts and other locations –www.sick.com