



MZC1-2V2NS-KR0

MZC1

SENSORS FOR C-SLOT CYLINDERS

SICK
Sensor Intelligence.



Ordering information

Type	Part no.
MZC1-2V2NS-KR0	1059742

Other models and accessories → www.sick.com/MZC1



Detailed technical data

Features

Cylinder type	C-slot
Cylinder types with adapter	SMC rail CDQ2 SMC rail ECDQ2 Round body cylinder Profile cylinders and tie-rod cylinders
Housing length	23.7 mm
Switching output	NPN
Switching frequency	1,000 Hz
Output function	NO
Electrical wiring	DC 3-wire
Enclosure rating	IP68

Mechanics/electronics

Supply voltage	10 V DC ... 30 V DC
Power consumption	8 mA, without load
Voltage drop	≤ 2.5 V
Continuous current I_a	≤ 100 mA
Protection class	III
Response sensitivity, typ.	2.2 mT
Overrun distance, typ.	4 mm
Hysteresis, typ.	≤ 0.8 mT
Reproducibility	≤ 0.1 mT ¹⁾
Reverse polarity protection	Yes
Short-circuit protection	Yes
Status indicator LED	Yes
Power-up pulse protection	Yes
Ambient operating temperature	-30 °C ... +80 °C

¹⁾ Supply voltage U_B and constant ambient temperature T_a.

Shock and vibration resistance	30 g, 11 ms / 10 ... 55 Hz, 1 mm
EMC	According to EN 60947-5-2
Connection type	Cable with connector M8, 3-pin, with knurled nuts, drag chain use, 0.3 m
Connection type Detail	
Conductor cross section	0.09 mm ²
Cable diameter	Ø 2.2 mm
Bending radius	With fixed installation > 2 x cable diameter For flexible use > 5 x cable diameter
Torsion force	± 270° / 0.1 m
Torsion cycles	300,000
Drag chain cycles	5,000,000
Drag chain parameters	Traversing speed max. 3 m/s Acceleration max. 10 m/s ² Bending cycles in the drag chain min. 5 million
Cable outlet	Axial
Material	
Housing	Plastic
Cable	PUR
UL File No.	NRKH.E181493 & NRKH7.E181493

¹⁾ Supply voltage U_B and constant ambient temperature T_a .

Safety-related parameters

MTTF_D	2,461 years
DC_{avg}	0 %
T_M (mission time)	20 years

Classifications

ECLASS 5.0	27270104
ECLASS 5.1.4	27270104
ECLASS 6.0	27270104
ECLASS 6.2	27270104
ECLASS 7.0	27270104
ECLASS 8.0	27270104
ECLASS 8.1	27270104
ECLASS 9.0	27270104
ECLASS 10.0	27270104
ECLASS 11.0	27270104
ECLASS 12.0	27274301
ETIM 5.0	EC002544
ETIM 6.0	EC002544
ETIM 7.0	EC002544
ETIM 8.0	EC002544
UNSPSC 16.0901	39122230

Installation note

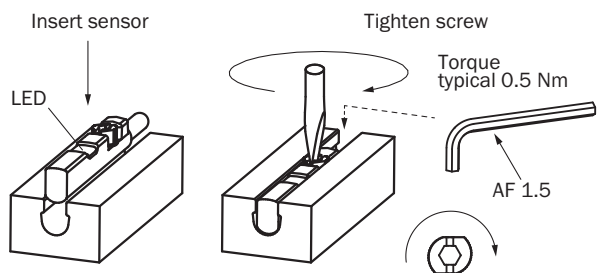

Connection type



Connection diagram

Cd-002

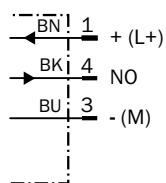

Dimensional drawing (Dimensions in mm (inch))

Cable with connector M8, with knurled nuts

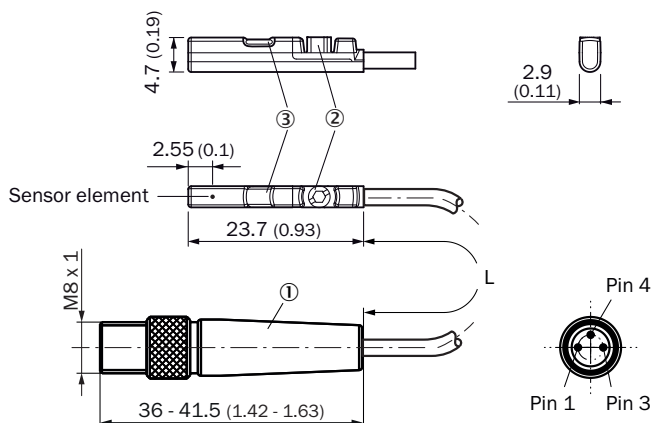





- ① Connection
- ② Fixing screw SW 1.5
- ③ Display LED

Recommended accessories

Other models and accessories → www.sick.com/MZC1

	Brief description	Type	Part no.
Brackets for cylinder sensors			
	Mounting bracket for integrated profile cylinder/tie-rod cylinder, zinc diecast, mounting hardware included	BEF-KHZ-PC1	2076170
	1 piece, Mounting bracket on round body cylinder with piston diameter of 12 mm, ambient temperature min 0 °C max 50 °C, plastic, Aluminum	BEF-KHZ-RC-12	2077673
	1 piece, Mounting bracket on round body cylinder with piston diameter of 16 mm, ambient temperature min 0 °C max 50 °C, plastic, Aluminum	BEF-KHZ-RC-16	2077672
	1 piece, Mounting bracket on round body cylinder with piston diameter of 20 mm, ambient temperature min 0 °C max 50 °C, plastic, Aluminum	BEF-KHZ-RC-20	2077671
	1 piece, Mounting bracket on round body cylinder with piston diameter of 25 mm, ambient temperature min 0 °C max 50 °C, plastic, Aluminum	BEF-KHZ-RC-25	2077670
	1 piece, Mounting bracket on round body cylinder with piston diameter of 32 mm, ambient temperature min 0 °C max 50 °C, plastic, Aluminum	BEF-KHZ-RC-32	2077669
	1 piece, Mounting bracket on round body cylinder with piston diameter of 40 mm, ambient temperature min 0 °C max 50 °C, plastic, Aluminum	BEF-KHZ-RC-40	2077668
	1 piece, Mounting bracket on round body cylinder with piston diameter of 50 mm, ambient temperature min 0 °C max 50 °C, plastic, Aluminum	BEF-KHZ-RC-50	2077667
	1 piece, Mounting bracket on round body cylinder with piston diameter of 63 mm, ambient temperature min 0 °C max 50 °C, plastic, Aluminum	BEF-KHZ-RC-63	2077666
	1 piece, Mounting bracket on round body cylinder with piston diameter of 1 mm ... 130 mm, ambient temperature min -30 °C max 80 °C, stainless steel, Aluminum	BEF-KHZ-RC1-130	2077686
	1 piece, Mounting bracket on round body cylinder with piston diameter of 1 mm ... 25 mm, ambient temperature min -30 °C max 80 °C, stainless steel, Aluminum	BEF-KHZ-RC1-25	2077685
Plug connectors and cables			
	<ul style="list-style-type: none"> • Connection type head A: Female connector, M8, 3-pin, straight, A-coded • Connection type head B: Flying leads • Signal type: Sensor/actuator cable • Cable: 2 m, 3-wire, PVC • Description: Sensor/actuator cable, unshielded • Application: Zones with chemicals 	YF8U13-020VA1XLEAX	2095860
	<ul style="list-style-type: none"> • Connection type head A: Female connector, M8, 3-pin, straight, A-coded • Connection type head B: Flying leads • Signal type: Sensor/actuator cable • Cable: 5 m, 3-wire, PVC • Description: Sensor/actuator cable, unshielded • Application: Zones with chemicals 	YF8U13-050VA1XLEAX	2095884
	<ul style="list-style-type: none"> • Connection type head A: Female connector, M8, 3-pin, angled, A-coded • Connection type head B: Flying leads • Signal type: Sensor/actuator cable • Cable: 2 m, 3-wire, PUR, halogen-free • Description: Sensor/actuator cable, unshielded • Application: Zones with oils and lubricants, Drag chain operation, Robot 	YG8U13-020UA1XLEAX	2094794
	<ul style="list-style-type: none"> • Connection type head A: Female connector, M8, 3-pin, angled, A-coded • Connection type head B: Flying leads • Signal type: Sensor/actuator cable • Cable: 2 m, 3-wire, PVC • Description: Sensor/actuator cable, unshielded • Application: Zones with chemicals 	YG8U13-020VA1XLEAX	2096165

	Brief description	Type	Part no.
	<ul style="list-style-type: none"> • Connection type head A: Female connector, M8, 3-pin, angled, A-coded • Connection type head B: Flying leads • Signal type: Sensor/actuator cable • Cable: 5 m, 3-wire, PUR, halogen-free • Description: Sensor/actuator cable, unshielded • Application: Zones with oils and lubricants, Drag chain operation, Robot 	YG8U13-050UA1XLEAX	2095586
	<ul style="list-style-type: none"> • Connection type head A: Female connector, M8, 3-pin, angled, A-coded • Connection type head B: Flying leads • Signal type: Sensor/actuator cable • Cable: 5 m, 3-wire, PVC • Description: Sensor/actuator cable, unshielded • Application: Zones with chemicals 	YG8U13-050VA1XLEAX	2096166
	<ul style="list-style-type: none"> • Connection type head A: Female connector, M8, 3-pin, straight • Description: Unshielded • Connection systems: Screw-type terminals • Permitted cross-section: 0.14 mm² ... 0.5 mm² 	DOS-0803-G	7902077
	<ul style="list-style-type: none"> • Connection type head A: Female connector, M8, 3-pin, angled • Description: Unshielded • Connection systems: Solder connection • Permitted cross-section: ≤ 0.25 mm² 	DOS-0803-W	7902078

SICK AT A GLANCE

SICK is one of the leading manufacturers of intelligent sensors and sensor solutions for industrial applications. A unique range of products and services creates the perfect basis for controlling processes securely and efficiently, protecting individuals from accidents and preventing damage to the environment.

We have extensive experience in a wide range of industries and understand their processes and requirements. With intelligent sensors, we can deliver exactly what our customers need. In application centers in Europe, Asia and North America, system solutions are tested and optimized in accordance with customer specifications. All this makes us a reliable supplier and development partner.

Comprehensive services complete our offering: SICK LifeTime Services provide support throughout the machine life cycle and ensure safety and productivity.

For us, that is “Sensor Intelligence.”

WORLDWIDE PRESENCE:

Contacts and other locations –www.sick.com