



UM18-212165102

UM18

ULTRASONIC DISTANCE SENSORS

**SICK**  
Sensor Intelligence.

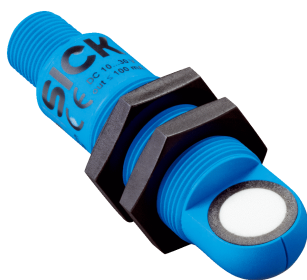

### Ordering information

| Type           | Part no. |
|----------------|----------|
| UM18-212165102 | 6048419  |

Other models and accessories → [www.sick.com/UM18](http://www.sick.com/UM18)



### Detailed technical data

#### Mechanics/electronics

|  |  |
|--|--|
| <b>Supply voltage <math>V_s</math></b> | DC 10 V ... 30 V <sup>1)</sup>   |
| <b>Power consumption</b>               | $\leq 1.2 \text{ W}$ <sup>2)</sup>   |
| <b>Initialization time</b>             | < 300 ms   |
| <b>Design</b>                          | Cylindrical  |
| <b>Housing material</b>                | Plastic (PBT, ultrasonic transducer: polyurethane foam, glass epoxy resin) |
| <b>Thread size</b>                     | M18 x 1  |
| <b>Connection type</b>                 | Male connector, M12, 4-pin   |
| <b>Indication</b>                      | 2 x LED  |
| <b>Weight</b>                          | 20 g   |
| <b>Sending axis</b>                    | Angled   |
| <b>Dimensions (W x H x D)</b>          | 18 mm x 18 mm x 68.7 mm  |
| <b>Enclosure rating</b>                | IP65 / IP67  |
| <b>Protection class</b>                | III  |

<sup>1)</sup> Limit values, reverse-polarity protected Operation in short-circuit protected network: max. 8 A, class 2.

<sup>2)</sup> Without load.

#### Safety-related parameters

|                         |           |
|-------------------------|-----------|
| <b>MTTF<sub>D</sub></b> | 101 years |
| <b>DC<sub>avg</sub></b> | 0%        |

#### Performance

|  |                             |
|--|-----------------------------|
| <b>Operating range, limiting range</b> | 65 mm ... 350 mm, 600 mm    |
| <b>Target</b>                          | Natural objects             |
| <b>Resolution</b>                      | $\geq 0.2 \text{ mm}$       |
| <b>Repeatability</b>                   | $\pm 0.15 \%$ <sup>1)</sup> |
| <b>Accuracy</b>                        | $\pm 1 \%$ <sup>2)</sup>    |
| <b>Response time</b>                   | 64 ms                       |

<sup>1)</sup> In relation to the current measured value, minimum value  $\geq$  resolution.

<sup>2)</sup> Referring to current measurement value.

|                                       |  |
|---------------------------------------|--|
| <b>Switching frequency</b>            | 12 Hz  |
| <b>Output time</b>                    | 16 ms  |
| <b>Ultrasonic frequency (typical)</b> | 400 kHz  |
| <b>Detection area (typical)</b>       | See diagrams   |
| <b>Additional function</b>            | Set switching mode: Distance to object (DtO) / Window (Wnd) / Object between sensor and background (ObSB)<br>Teach-in of digital output<br>Invertible digital output<br>Reset to factory default |

<sup>1)</sup> In relation to the current measured value, minimum value  $\geq$  resolution.

<sup>2)</sup> Referring to current measurement value.

## Interfaces

|                       |  |
|-----------------------|--|
| <b>Digital output</b> |  |
|                       | Number 1 <sup>1)</sup>                   |
|                       | Type NPN                                 |
|                       | Maximum output current $I_A \leq 200$ mA |
| <b>Hysteresis</b>     | 5 mm                                     |

<sup>1)</sup> NPN: HIGH =  $\leq 2$  V / LOW =  $U_V$ .

## Ambient data

|                                       |                          |
|---------------------------------------|--------------------------|
| <b>Ambient temperature, operation</b> | -25 °C ... +70 °C        |
| <b>Ambient temperature, storage</b>   | -40 °C ... +85 °C        |
| <b>Temperature drift</b>              | 0.17 % / K <sup>1)</sup> |

<sup>1)</sup> Referring to current measurement value.

## Classifications

|                       |          |
|-----------------------|----------|
| <b>ECLASS 5.0</b>     | 27270804 |
| <b>ECLASS 5.1.4</b>   | 27270804 |
| <b>ECLASS 6.0</b>     | 27270804 |
| <b>ECLASS 6.2</b>     | 27270804 |
| <b>ECLASS 7.0</b>     | 27270804 |
| <b>ECLASS 8.0</b>     | 27270804 |
| <b>ECLASS 8.1</b>     | 27270804 |
| <b>ECLASS 9.0</b>     | 27270804 |
| <b>ECLASS 10.0</b>    | 27270804 |
| <b>ECLASS 11.0</b>    | 27270804 |
| <b>ECLASS 12.0</b>    | 27272806 |
| <b>ETIM 5.0</b>       | EC001846 |
| <b>ETIM 6.0</b>       | EC001846 |
| <b>ETIM 7.0</b>       | EC001846 |
| <b>ETIM 8.0</b>       | EC001846 |
| <b>UNSPSC 16.0901</b> | 41111960 |

**Dimensional drawing** (Dimensions in mm (inch))

UM18-2xxxxx2

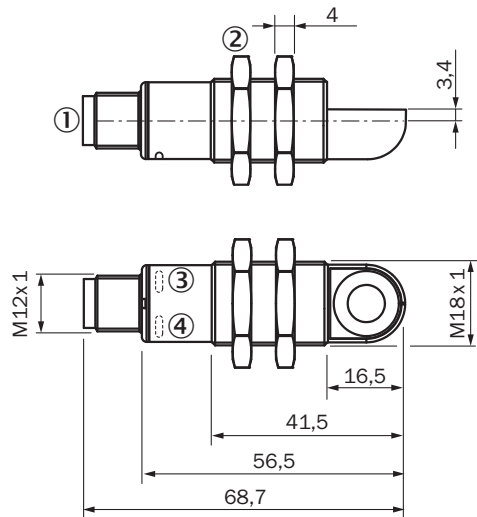

- ① Connection
- ② Fixing nuts, width 24 mm
- ③ Status display for supply voltage active (green)
- ④ Status indicator switching/analog output (orange)

**Connection type**

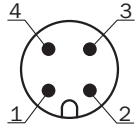

**Connection diagram**

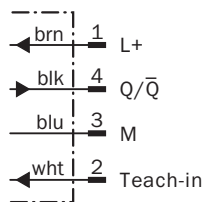

## Detection area

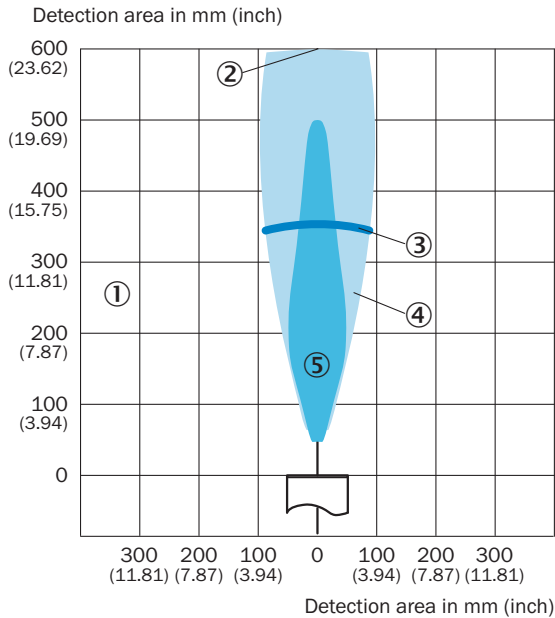

UM18-212



- ① Detection range dependent on reflection properties, size, and alignment of the object
- ② Limiting range
- ③ Operating range
- ④ Example object: aligned plate 500 mm x 500 mm
- ⑤ Example object: pipe with 27 mm diameter

## Recommended accessories

Other models and accessories → [www.sick.com/UM18](http://www.sick.com/UM18)

|   | Brief description   | Type               | Part no. |
|---|---|--------------------|----------|
| <b>Deflector mirrors</b>  |   |                    |          |
|  | 90° sound deflection plate for UM18-1xxxx and UM18-2xxxx, stainless steel, for straight versions  | USP-UM18           | 5323658  |
| <b>Mounting brackets and plates</b>   |   |                    |          |
|  | Mounting plate for M18 sensors, steel, zinc coated, without mounting hardware   | BEF-WG-M18         | 5321870  |
| <b>Others</b>   |   |                    |          |
|  | <ul style="list-style-type: none"> <li>• <b>Connection type head A:</b> Female connector, M12, 4-pin, straight, A-coded</li> <li>• <b>Connection type head B:</b> Flying leads</li> <li>• <b>Signal type:</b> Sensor/actuator cable</li> <li>• <b>Cable:</b> 2 m, 4-wire, PVC</li> <li>• <b>Description:</b> Sensor/actuator cable, unshielded</li> <li>• <b>Application:</b> Zones with chemicals</li> </ul> | YF2A14-020VB3XLEAX | 2096234  |

## SICK AT A GLANCE

SICK is one of the leading manufacturers of intelligent sensors and sensor solutions for industrial applications. A unique range of products and services creates the perfect basis for controlling processes securely and efficiently, protecting individuals from accidents and preventing damage to the environment.

We have extensive experience in a wide range of industries and understand their processes and requirements. With intelligent sensors, we can deliver exactly what our customers need. In application centers in Europe, Asia and North America, system solutions are tested and optimized in accordance with customer specifications. All this makes us a reliable supplier and development partner.

Comprehensive services complete our offering: SICK LifeTime Services provide support throughout the machine life cycle and ensure safety and productivity.

For us, that is “Sensor Intelligence.”

## WORLDWIDE PRESENCE:

Contacts and other locations –[www.sick.com](http://www.sick.com)