



**CQ4-08ENOKT1**  
CQ

**CAPACITIVE PROXIMITY SENSORS**

**SICK**  
Sensor Intelligence.



Illustration may differ

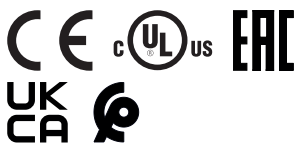

## Ordering information

Type	Part no.
CQ4-08ENOKT1	6051007

Other models and accessories → [www.sick.com/CQ](http://www.sick.com/CQ)

## Detailed technical data

### Features

<b>Housing</b>	Rectangular
<b>Dimensions (W x H x D)</b>	16 mm x 39.5 mm x 12 mm
<b>Sensing range <math>S_n</math></b>	1 mm ... 8 mm <sup>1)</sup> 1 mm ... 6 mm <sup>2)</sup>
<b>Safe sensing range <math>S_a</math></b>	5.76 mm
<b>Installation type</b>	Non-flush Flush
<b>Switching frequency</b>	100 Hz
<b>Connection type</b>	Connector M8, 3-pin
<b>Switching output</b>	NPN
<b>Output function</b>	NC
<b>Electrical wiring</b>	DC 3-wire
<b>Adjustment</b>	Potentiometer, 5 turns (Sensitivity)
<b>Enclosure rating</b>	IP67 <sup>3)</sup>
<b>Items supplied</b>	Screwdriver for potentiometer adjustment (1 x)

<sup>1)</sup> For non-flush installation.

<sup>2)</sup> For flush mounting.

<sup>3)</sup> According to EN 60529.

### Mechanics/electronics

<b>Supply voltage</b>	10 V DC ... 30 V DC
-----------------------	---------------------

<sup>1)</sup> At  $I_a$  max.

<sup>2)</sup> Without load.

<sup>3)</sup> Depending on installation and environmental conditions and sensitivity adjustment, hysteresis may vary.

<sup>4)</sup> Of  $S_r$ .

<sup>5)</sup> Supply voltage  $U_b$  and constant ambient temperature  $T_a$ .

<b>Ripple</b>	≤ 10 %
<b>Voltage drop</b>	≤ 2.5 V DC <sup>1)</sup>
<b>Current consumption</b>	12 mA <sup>2)</sup>
<b>Time delay before availability</b>	≤ 200 ms
<b>Hysteresis</b>	4 % ... 20 % <sup>3)</sup>
<b>Reproducibility</b>	≤ 5 % <sup>4) 5)</sup>
<b>Temperature drift (of S<sub>r</sub>)</b>	± 20 %
<b>EMC</b>	According to EN 60947-5-2
<b>Continuous current I<sub>a</sub></b>	≤ 150 mA
<b>Short-circuit protection</b>	✓
<b>Reverse polarity protection</b>	✓
<b>Power-up pulse protection</b>	✓
<b>Shock and vibration resistance</b>	30 g, 11 ms / 10 ... 55 Hz, 1 mm
<b>Ambient operating temperature</b>	-20 °C ... +75 °C
<b>Ambient temperature, storage</b>	-40 °C ... +85 °C
<b>Housing material</b>	Plastic, ABS
<b>Sensing face material</b>	Plastic
<b>UL File No.</b>	NRKH.E191603

1) At I<sub>a</sub> max.

2) Without load.

3) Depending on installation and environmental conditions and sensitivity adjustment, hysteresis may vary.

4) Of S<sub>r</sub>.

5) Supply voltage U<sub>b</sub> and constant ambient temperature T<sub>a</sub>.

### Safety-related parameters

<b>MTTF<sub>D</sub></b>	1,344 years
<b>DC<sub>avg</sub></b>	0 %
<b>T<sub>M</sub> (mission time)</b>	20 years

### Reduction factors

<b>Note</b>	The values are reference values which may vary
<b>Metal</b>	1
<b>Water</b>	1
<b>PVC</b>	Approx. 0.4
<b>Oil</b>	Approx. 0.25
<b>Glass</b>	0.6
<b>Ceramics</b>	0.5
<b>Alcohol</b>	0.7
<b>Wood</b>	0.2 ... 0.7

### Installation note

<b>Remark</b>	Associated graphic see "Installation"
<b>A</b>	16 mm
<b>B</b>	16 mm

<b>F</b>	48 mm
----------	-------

### Classifications

<b>eCl@ss 5.0</b>	27270102
<b>eCl@ss 5.1.4</b>	27270102
<b>eCl@ss 6.0</b>	27270102
<b>eCl@ss 6.2</b>	27270102
<b>eCl@ss 7.0</b>	27270102
<b>eCl@ss 8.0</b>	27270102
<b>eCl@ss 8.1</b>	27270102
<b>eCl@ss 9.0</b>	27270102
<b>eCl@ss 10.0</b>	27270102
<b>eCl@ss 11.0</b>	27270102
<b>eCl@ss 12.0</b>	27274201
<b>ETIM 5.0</b>	EC002715
<b>ETIM 6.0</b>	EC002715
<b>ETIM 7.0</b>	EC002715
<b>ETIM 8.0</b>	EC002715
<b>UNSPSC 16.0901</b>	39122230

### Installation note

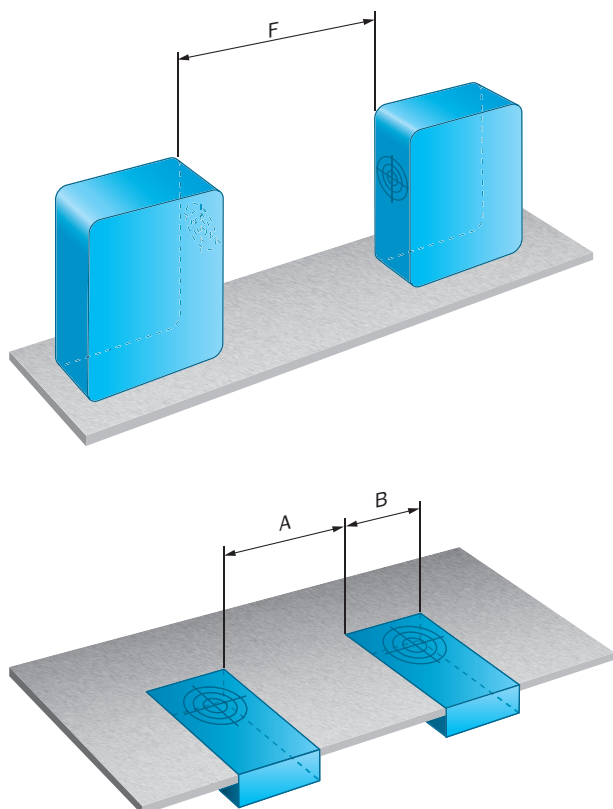

### Connection diagram

Cd-045

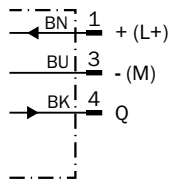

### Response diagram

CQ4, Non-flush installation

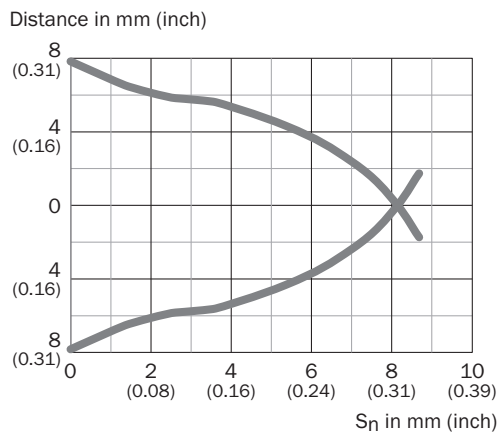

CQ4, Flush installation

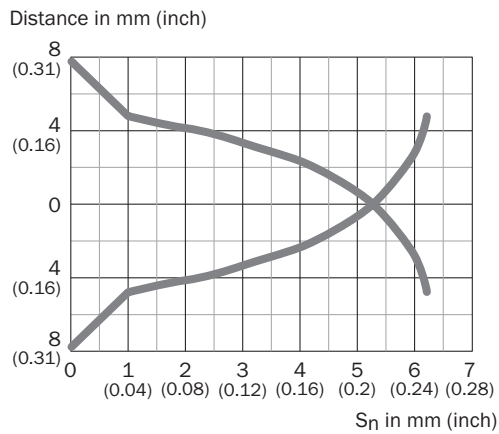

**Dimensional drawing** (Dimensions in mm (inch))

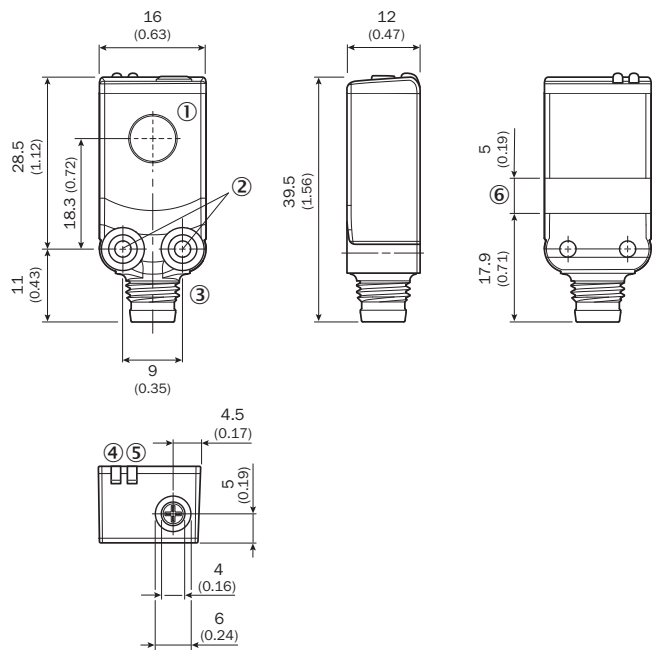

CQ4, connector







- ① Sensing face
- ② Threaded hole M3 (2 x)
- ③ Connector M8, 3-pin
- ④ Yellow LED: status detection of object/medium
- ⑤ LED green: operating indicator
- ⑥ Line for cable tie

**Recommended accessories**

Other models and accessories → [www.sick.com/CQ](http://www.sick.com/CQ)

	Brief description	Type	Part no.
<b>Mounting brackets and plates</b>			
	Mounting bracket for wall mounting, Stainless steel 1.4571, mounting hardware included	BEF-W4-A	2051628
	Mounting bracket for floor mounting, Stainless steel 1.4571, mounting hardware included	BEF-W4-B	2051630
<b>Plug connectors and cables</b>			
	Head A: female connector, M8, 3-pin, straight, A-coded Head B: Flying leads Cable: Sensor/actuator cable, PVC, unshielded, 2 m	YF8U13-020VA1XLEAX	2095860
	Head A: female connector, M8, 3-pin, straight, A-coded Head B: Flying leads Cable: Sensor/actuator cable, PVC, unshielded, 5 m	YF8U13-050VA1XLEAX	2095884

	Brief description	Type	Part no.
	Head A: female connector, M8, 3-pin, angled, A-coded Head B: Flying leads Cable: Sensor/actuator cable, PVC, unshielded, 2 m	YG8U13-020VA1XLEAX	2096165
	Head A: female connector, M8, 3-pin, angled, A-coded Head B: Flying leads Cable: Sensor/actuator cable, PVC, unshielded, 5 m	YG8U13-050VA1XLEAX	2096166
	Head A: female connector, M8, 3-pin, straight Cable: unshielded	DOS-0803-G	7902077
	Head A: female connector, M8, 3-pin, angled Cable: unshielded	DOS-0803-W	7902078
Terminal and alignment brackets			
	Ball clamp bracket, plastic, mounting hardware included	BEF-GH-MINI01	2023160

## SICK AT A GLANCE

SICK is one of the leading manufacturers of intelligent sensors and sensor solutions for industrial applications. A unique range of products and services creates the perfect basis for controlling processes securely and efficiently, protecting individuals from accidents and preventing damage to the environment.

We have extensive experience in a wide range of industries and understand their processes and requirements. With intelligent sensors, we can deliver exactly what our customers need. In application centers in Europe, Asia and North America, system solutions are tested and optimized in accordance with customer specifications. All this makes us a reliable supplier and development partner.

Comprehensive services complete our offering: SICK LifeTime Services provide support throughout the machine life cycle and ensure safety and productivity.

For us, that is “Sensor Intelligence.”

## WORLDWIDE PRESENCE:

Contacts and other locations –[www.sick.com](http://www.sick.com)