



# WL9LGC-3P2452A71

W9

SMALL PHOTOELECTRIC SENSORS

**SICK**  
Sensor Intelligence.



Illustration may differ

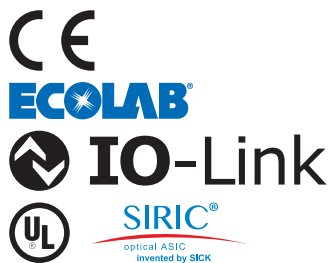

## Ordering information

| Type             | Part no. |
|------------------|----------|
| WL9LGC-3P2452A71 | 1080956  |

The sensor is equipped with a special Smart Task function. Additional information can be found in the "Technical Data." Use of the sensor for pure object detection is limited.

Other models and accessories → [www.sick.com/W9](http://www.sick.com/W9)

## Detailed technical data

### Features

|                                        |                                                                                                                     |
|----------------------------------------|---------------------------------------------------------------------------------------------------------------------|
| <b>Functional principle</b>            | Photoelectric retro-reflective sensor                                                                               |
| <b>Functional principle detail</b>     | Autocollimation                                                                                                     |
| <b>Dimensions (W x H x D)</b>          | 12.2 mm x 52.2 mm x 23.6 mm                                                                                         |
| <b>Housing design (light emission)</b> | Rectangular                                                                                                         |
| <b>Mounting hole</b>                   | M3                                                                                                                  |
| <b>Sensing range max.</b>              | 0 m ... 3.5 m <sup>1) 2)</sup>                                                                                      |
| <b>Sensing range</b>                   | 0 m ... 2.2 m <sup>1) 2)</sup>                                                                                      |
| <b>Type of light</b>                   | Visible red light                                                                                                   |
| <b>Light source</b>                    | Laser <sup>3)</sup>                                                                                                 |
| <b>Light spot size (distance)</b>      | Ø 0.4 mm (60 mm)                                                                                                    |
| <b>Wave length</b>                     | 650 nm                                                                                                              |
| <b>Laser class</b>                     | 1 (IEC 60825-1 / CDRH 21 CFR 1040.10 & 1040.11)                                                                     |
| <b>Adjustment</b>                      | IO-Link<br>Single teach-in button                                                                                   |
| <b>Pin 2 configuration</b>             | External input, Teach-in input, Sender off input, Detection output, logic output, Device contamination alarm output |
| <b>AutoAdapt</b>                       | ✓                                                                                                                   |
| <b>Special feature</b>                 | Detecting transparent objects                                                                                       |

<sup>1)</sup> Reflective tape REF-AC1000.

<sup>2)</sup> To ensure reliable operation, we recommend using REF-AC1000 reflective tape or reflective-tap reflectors such as P41F, PLV14-A, PLH25-M12, or PLH25-D12. Reflectors with large-scale triple structures must only be used if deemed suitable for the application.

<sup>3)</sup> Average service life: 50,000 h at T<sub>J</sub> = +25 °C.

|                             |                                                        |
|-----------------------------|--------------------------------------------------------|
| <b>Special applications</b> | Detecting small objects, Detecting transparent objects |
|-----------------------------|--------------------------------------------------------|

- 1) Reflective tape REF-AC1000.  
 2) To ensure reliable operation, we recommend using REF-AC1000 reflective tape or reflective-tap reflectors such as P41F, PLV14-A, PLH25-M12, or PLH25-D12. Reflectors with large-scale triple structures must only be used if deemed suitable for the application.  
 3) Average service life: 50,000 h at  $T_U = +25\text{ °C}$ .

## Mechanics/electronics

|                                            |                                                          |
|--------------------------------------------|----------------------------------------------------------|
| <b>Supply voltage <math>U_B</math></b>     | 10 V DC ... 30 V DC <sup>1)</sup>                        |
| <b>Ripple</b>                              | < 5 V <sub>pp</sub> <sup>2)</sup>                        |
| <b>Current consumption</b>                 | 30 mA <sup>3)</sup>                                      |
| <b>Switching output</b>                    | PNP <sup>4) 5)</sup>                                     |
| <b>Output function</b>                     | Complementary                                            |
| <b>Switching mode</b>                      | Light/dark switching <sup>4)</sup>                       |
| <b>Output current <math>I_{max}</math></b> | ≤ 100 mA                                                 |
| <b>Response time</b>                       | ≤ 0.5 ms <sup>6)</sup>                                   |
| <b>Response time Q/ on Pin 2</b>           | 300 μs ... 450 μs <sup>6) 7)</sup>                       |
| <b>Switching frequency</b>                 | 1,000 Hz <sup>8)</sup>                                   |
| <b>Switching frequency Q / to pin 2</b>    | ≤ 1,000 Hz <sup>9)</sup>                                 |
| <b>Connection type</b>                     | Male connector M12, 4-pin                                |
| <b>Circuit protection</b>                  | A <sup>10)</sup><br>B <sup>11)</sup><br>C <sup>12)</sup> |
| <b>Protection class</b>                    | III                                                      |
| <b>Weight</b>                              | 13 g                                                     |
| <b>Polarisation filter</b>                 | ✓                                                        |
| <b>Housing material</b>                    | Plastic, VISTAL®                                         |
| <b>Optics material</b>                     | Plastic, PMMA                                            |
| <b>Enclosure rating</b>                    | IP66<br>IP67<br>IP69K                                    |
| <b>Special feature</b>                     | Detecting transparent objects                            |
| <b>Ambient operating temperature</b>       | -10 °C ... +50 °C                                        |

- 1) Limit values when operated in short-circuit protected network: max. 8 A.  
 2) May not exceed or fall below  $U_V$  tolerances.  
 3) Without load.  
 4) Q = light switching.  
 5) Pin 4: this switching output must not be connected to any other output.  
 6) Signal transit time with resistive load.  
 7) Valid for Q \ on Pin2, if configured with software.  
 8) With light/dark ratio 1:1.  
 9) With light / dark ratio 1:1, valid for Q \ on Pin2, if configured with software.  
 10) A =  $V_S$  connections reverse-polarity protected.  
 11) B = inputs and output reverse-polarity protected.  
 12) C = interference suppression.  
 13) As of  $T_a = 50\text{ °C}$ , a max. supply voltage  $V_{max} = 24\text{ V}$  and a max. load current  $I_{max} = 50\text{ mA}$  is permitted.  
 14) Operation below  $T_U -10\text{ °C}$  is possible if the sensor is already switched on at  $T_U > -10\text{ °C}$ , then cools down, and the supply voltage is subsequently not switched off. Switching on below  $T_U -10\text{ °C}$  is not permissible.

|                                               |                                      |
|-----------------------------------------------|--------------------------------------|
| <b>Ambient operating temperature extended</b> | -30 °C ... +55 °C <sup>13) 14)</sup> |
| <b>Ambient temperature, storage</b>           | -30 °C ... +70 °C                    |
| <b>UL File No.</b>                            | NRKH.E181493                         |
| <b>Repeatability Q/ on Pin 2:</b>             | 150 µs <sup>7)</sup>                 |

<sup>1)</sup> Limit values when operated in short-circuit protected network: max. 8 A.

<sup>2)</sup> May not exceed or fall below  $U_V$  tolerances.

<sup>3)</sup> Without load.

<sup>4)</sup> Q = light switching.

<sup>5)</sup> Pin 4: this switching output must not be connected to any other output.

<sup>6)</sup> Signal transit time with resistive load.

<sup>7)</sup> Valid for Q \ on Pin2, if configured with software.

<sup>8)</sup> With light/dark ratio 1:1.

<sup>9)</sup> With light / dark ratio 1:1, valid for Q \ on Pin2, if configured with software.

<sup>10)</sup> A =  $V_S$  connections reverse-polarity protected.

<sup>11)</sup> B = inputs and output reverse-polarity protected.

<sup>12)</sup> C = interference suppression.

<sup>13)</sup> As of  $T_a = 50$  °C, a max. supply voltage  $V_{max.} = 24$  V and a max. load current  $I_{max.} = 50$  mA is permitted.

<sup>14)</sup> Operation below  $T_u -10$  °C is possible if the sensor is already switched on at  $T_u > -10$  °C, then cools down, and the supply voltage is subsequently not switched off. Switching on below  $T_u -10$  °C is not permissible.

### Safety-related parameters

|                                     |                                          |
|-------------------------------------|------------------------------------------|
| <b>MTTF<sub>D</sub></b>             | 562 years (EN ISO 13849-1) <sup>1)</sup> |
| <b>DC<sub>avg</sub></b>             | 0 %                                      |
| <b>T<sub>M</sub> (mission time)</b> | 10 years                                 |

<sup>1)</sup> Mode of calculation: Parts-Count-calculation.

### Communication interface

|                                       |                                                                                                          |
|---------------------------------------|----------------------------------------------------------------------------------------------------------|
| <b>Communication interface</b>        | IO-Link V1.1                                                                                             |
| <b>Communication Interface detail</b> | COM2 (38,4 kBaud)                                                                                        |
| <b>Cycle time</b>                     | 2.3 ms                                                                                                   |
| <b>Process data length</b>            | 16 Bit                                                                                                   |
| <b>Process data structure</b>         | Bit 0 = switching signal $Q_{L1}$<br>Bit 1 = switching signal $Q_{L2}$<br>Bit 2 ... 15 = measuring value |
| <b>VendorID</b>                       | 26                                                                                                       |
| <b>DeviceID HEX</b>                   | 0x80011A                                                                                                 |
| <b>DeviceID DEC</b>                   | 8388890                                                                                                  |

### Smart Task

|                        |                                                          |
|------------------------|----------------------------------------------------------|
| <b>Smart Task name</b> | Counter + debouncing                                     |
| <b>Logic function</b>  | Direct<br>WINDOW<br>Hysteresis                           |
| <b>Timer function</b>  | Deactivated<br>On delay<br>Off delay<br>ON and OFF delay |

<sup>1)</sup> SIO Direct: sensor operation in standard I/O mode without IO-Link communication and without using internal sensor logic or time parameters (set to "direct"/"deactivated").

<sup>2)</sup> SIO Logic: Sensor operation in standard I/O mode without IO-Link communication. Sensor-internal logic or timing parameters plus Automation Functions used.

<sup>3)</sup> IOL: Sensor operation with full IO-Link communication and usage of logic, timing and Automation Function parameters.

|                                                        |                                                                                                |
|--------------------------------------------------------|------------------------------------------------------------------------------------------------|
|                                                        | Impulse (one shot)                                                                             |
| <b>Inverter</b>                                        | Yes                                                                                            |
| <b>Maximum counting frequency</b>                      | SIO Direct: --- <sup>1)</sup><br>SIO Logic: 1000 Hz <sup>2)</sup><br>IOL: 900 Hz <sup>3)</sup> |
| <b>Counter reset</b>                                   | SIO Direct: ---<br>SIO Logic: 1,5 ms<br>IOL: 1,5 ms                                            |
| <b>Min. Time between two process events (switches)</b> | SIO Direct: ---<br>SIO Logic: 450 µs<br>IOL: 500 µs                                            |
| <b>Debounce time max.</b>                              | SIO Direct: ---<br>SIO Logic: 30.000 ms<br>IOL: 30.000 ms                                      |
| <b>Switching signal</b>                                |                                                                                                |
| Switching signal Q <sub>L1</sub>                       | Output type (dependant on the adjusted threshold)                                              |
| Switching signal Q <sub>L2</sub>                       | Output type (dependant on the adjusted threshold)                                              |
| <b>Measuring value</b>                                 | Counting value                                                                                 |

<sup>1)</sup> SIO Direct: sensor operation in standard I/O mode without IO-Link communication and without using internal sensor logic or time parameters (set to "direct"/"deactivated").

<sup>2)</sup> SIO Logic: Sensor operation in standard I/O mode without IO-Link communication. Sensor-internal logic or timing parameters plus Automation Functions used.

<sup>3)</sup> IOL: Sensor operation with full IO-Link communication and usage of logic, timing and Automation Function parameters.

## Diagnosis

|                         |                            |
|-------------------------|----------------------------|
| <b>Device status</b>    | Yes                        |
| <b>Quality of teach</b> | Yes                        |
| <b>Quality of run</b>   | Yes, Contamination display |

## Classifications

|                       |          |
|-----------------------|----------|
| <b>ECLASS 5.0</b>     | 27270902 |
| <b>ECLASS 5.1.4</b>   | 27270902 |
| <b>ECLASS 6.0</b>     | 27270902 |
| <b>ECLASS 6.2</b>     | 27270902 |
| <b>ECLASS 7.0</b>     | 27270902 |
| <b>ECLASS 8.0</b>     | 27270902 |
| <b>ECLASS 8.1</b>     | 27270902 |
| <b>ECLASS 9.0</b>     | 27270902 |
| <b>ECLASS 10.0</b>    | 27270902 |
| <b>ECLASS 11.0</b>    | 27270902 |
| <b>ECLASS 12.0</b>    | 27270902 |
| <b>ETIM 5.0</b>       | EC002717 |
| <b>ETIM 6.0</b>       | EC002717 |
| <b>ETIM 7.0</b>       | EC002717 |
| <b>ETIM 8.0</b>       | EC002717 |
| <b>UNSPSC 16.0901</b> | 39121528 |

## Adjustments

Single teach-in button

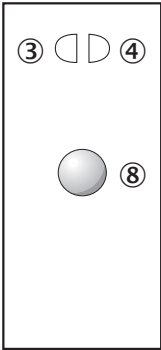

- ③ LED indicator yellow: Status of received light beam
- ④ LED indicator green: power on
- ⑧ Teach-in button

## Connection diagram

Cd-367

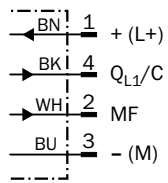

Cd-083

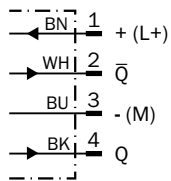

### Characteristic curve

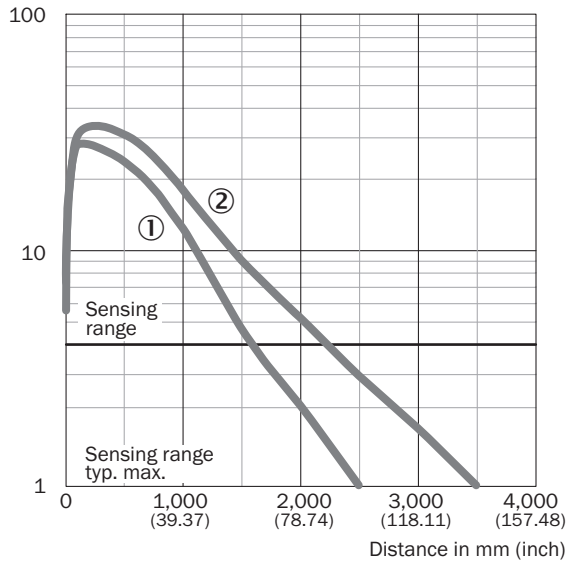

- ① Reflector PLV14-A / PLH25-M12 / PLH25-D12
- ② Reflector P41F / reflective tape REF-AC1000

### Light spot size

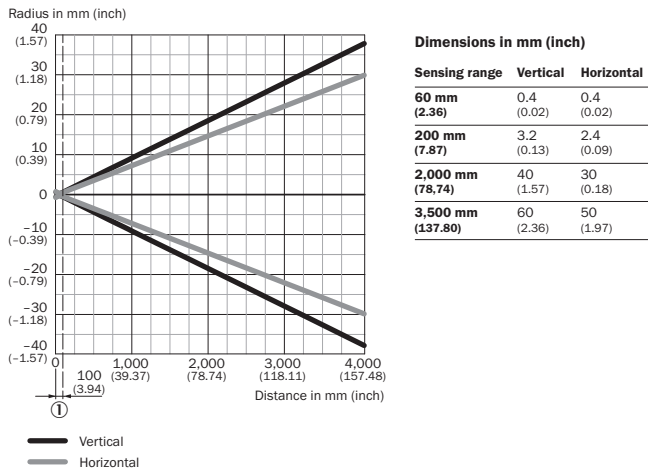

- ① Minimum distance between sensor and reflector

Light spot size (detailed view)

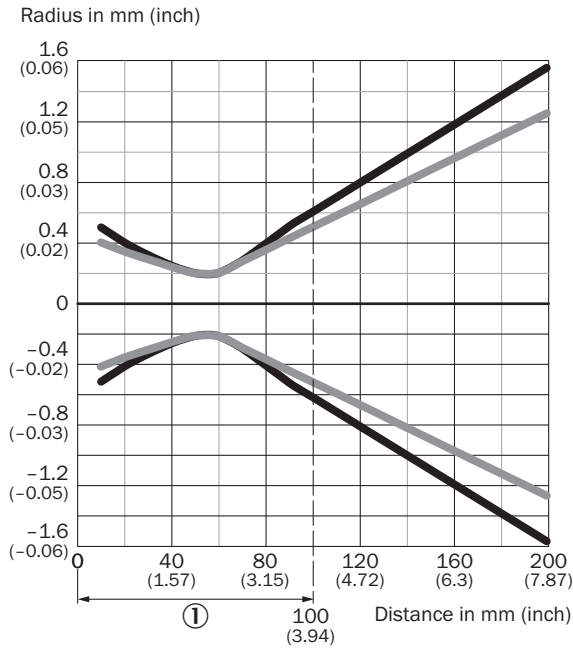

- Vertical
- Horizontal

① Minimum distance between sensor and reflector

Sensing range diagram

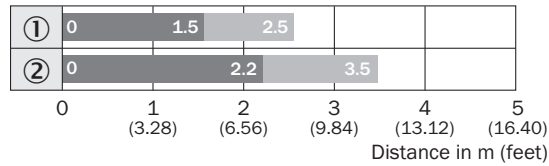

- Sensing range
  - Sensing range max.
- ① Reflector PLV14-A / PLH25-M12 / PLH25-D12  
 ② Reflector P41F / reflective tape REF-AC1000



**Dimensional drawing** (Dimensions in mm (inch))

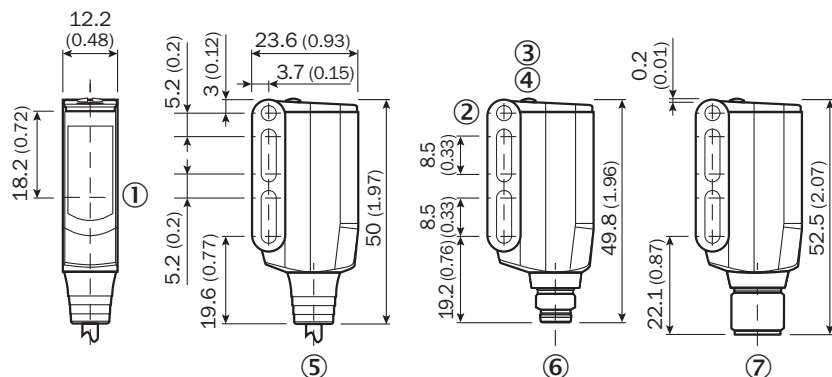

WL9L-3



- ① Sender and receiver optical axis center
- ② Mounting hole M3 (Ø 3.1 mm)
- ③ LED indicator yellow: Status of received light beam
- ④ LED indicator green: power on
- ⑤ Connecting cable or connecting cable with connector
- ⑥ Male connector M8, 4-pin
- ⑦ Male connector M12, 4-pin

**Recommended accessories**

Other models and accessories → [www.sick.com/W9](http://www.sick.com/W9)

|                                                                                     | Brief description                                                                                                                     | Type               | Part no. |
|-------------------------------------------------------------------------------------|---------------------------------------------------------------------------------------------------------------------------------------|--------------------|----------|
| <b>Plug connectors and cables</b>                                                   |                                                                                                                                       |                    |          |
|  | Head A: female connector, M12, 4-pin, straight, A-coded<br>Head B: Flying leads<br>Cable: Sensor/actuator cable, PVC, unshielded, 5 m | YF2A14-050VB3XLEAX | 2096235  |
|  | Head A: male connector, M12, 4-pin, straight<br>Cable: unshielded                                                                     | STE-1204-G         | 6009932  |
| <b>Reflectors</b>                                                                   |                                                                                                                                       |                    |          |
|  | Suitable for laser sensors, self-adhesive, cut, see alignment note, 56.3 mm x 56.3 mm, self-adhesive                                  | REF-AC1000-56      | 4063030  |

### Recommended services

Additional services → [www.sick.com/W9](http://www.sick.com/W9)

|                                                                                                                                                                                                                                                                                                                                                                                                                                                                                                                                                   | Type                   | Part no.   |
|---------------------------------------------------------------------------------------------------------------------------------------------------------------------------------------------------------------------------------------------------------------------------------------------------------------------------------------------------------------------------------------------------------------------------------------------------------------------------------------------------------------------------------------------------|------------------------|------------|
| Function Block Factory                                                                                                                                                                                                                                                                                                                                                                                                                                                                                                                            |                        |            |
| <ul style="list-style-type: none"><li>• <b>Description:</b> The Function Block Factory supports common programmable logic controllers (PLCs) from various manufacturers, such as Siemens, Beckhoff, Rockwell Automation and B&amp;R. More information on the FBF can be found <a _blank"="" href="https://fbf.cloud.sick.com target=">here</a>.</li><li>• <b>Note:</b> You can configure your function block at <a _blank"="" href="https://fbf.cloud.sick.com target=">Function Block Factory</a>. As a login please use your SICK ID.</li></ul> | Function Block Factory | On request |

## SICK AT A GLANCE

SICK is one of the leading manufacturers of intelligent sensors and sensor solutions for industrial applications. A unique range of products and services creates the perfect basis for controlling processes securely and efficiently, protecting individuals from accidents and preventing damage to the environment.

We have extensive experience in a wide range of industries and understand their processes and requirements. With intelligent sensors, we can deliver exactly what our customers need. In application centers in Europe, Asia and North America, system solutions are tested and optimized in accordance with customer specifications. All this makes us a reliable supplier and development partner.

Comprehensive services complete our offering: SICK LifeTime Services provide support throughout the machine life cycle and ensure safety and productivity.

For us, that is “Sensor Intelligence.”

## WORLDWIDE PRESENCE:

Contacts and other locations –[www.sick.com](http://www.sick.com)