



Signal tower
Ø70mm/2.75"
8TL7GL - Light
modules

Product designation

Product type designation

General characteristics

Diameter	mm - inch	70 / 2.75
Supply voltage (AC)	V	110...120
Colour		Red
IEC degree of protection		IP65

Mechanical features

Weight	g	83
--------	---	----

Ambient conditions

Temperature			
	Operating temperature	min	°C -20
		max	°C +50

Dimensions

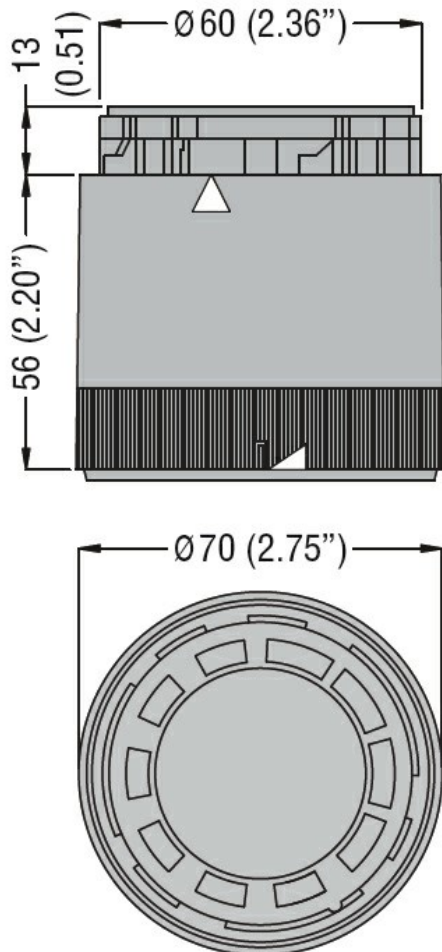

Wiring diagrams

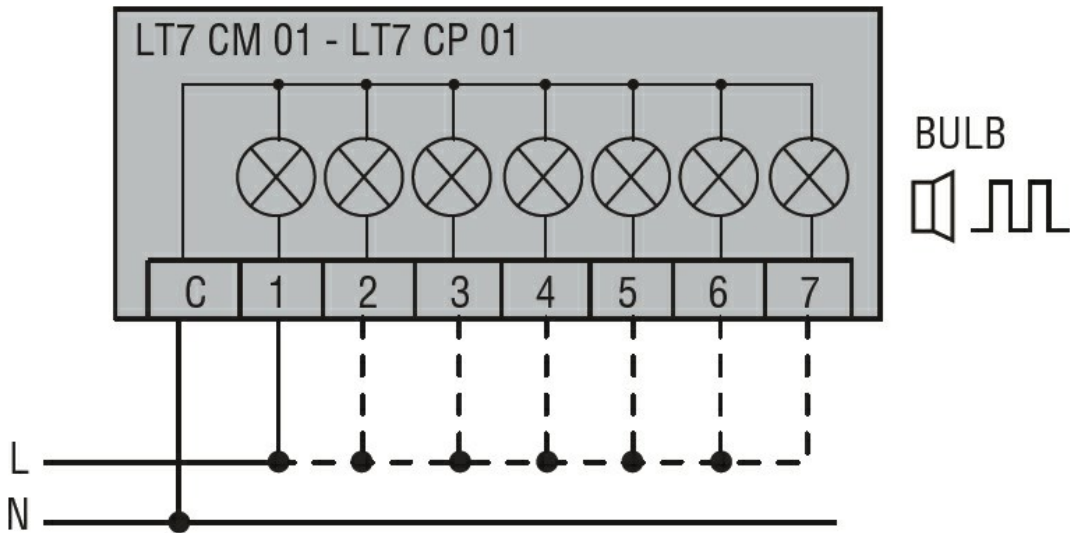

Connect terminals C and 1 as indicated to power the first module. If other modules are fitted, the respective terminals must be connected accordingly.

Certifications and compliance

Compliance

CSA C22.2 n° 14

IEC/EN 60947-1

IEC/EN 60947-5-1

UL508

Certificates

cULus

EAC

ETIM classification

ETIM 8.0

EC000232 -
 Optical module
 for signal tower