



WL100L-F1131S04

W100 Laser

MINIATURE PHOTOELECTRIC SENSORS

SICK
Sensor Intelligence.



Illustration may differ



Ordering information

Type	Part no.
WL100L-F1131S04	6051061

Included in delivery: BEF-W100-A (1), P250F (1)

Other models and accessories → www.sick.com/W100_Laser

Detailed technical data

Features

Functional principle	Photoelectric retro-reflective sensor
Functional principle detail	Dual lens
Dimensions (W x H x D)	11 mm x 31 mm x 20 mm
Housing design (light emission)	Rectangular
Sensing range max.	0.08 m ... 12 m ¹⁾
Sensing range	0.08 m ... 10 m ¹⁾
Type of light	Visible red light
Light source	Laser ²⁾
Light spot size (distance)	Ø 12 mm (10 m)
Wave length	650 nm
Laser class	1
Adjustment	Potentiometer, 270°
Special applications	Detecting small objects

¹⁾ Reflector P250F.

²⁾ Average service life: 50,000 h at T_U = +25 °C.

Mechanics/electronics

Supply voltage U_B	10 V DC ... 30 V DC ¹⁾
Ripple	± 10 % ²⁾

¹⁾ Limit values when operated in short-circuit protected network: max. 8 A.

²⁾ May not exceed or fall below U_V tolerances.

³⁾ Without load.

⁴⁾ Signal transit time with resistive load.

⁵⁾ With light/dark ratio 1:1.

⁶⁾ Do not bend below 0 °C.

⁷⁾ A = V_S connections reverse-polarity protected.

⁸⁾ B = inputs and output reverse-polarity protected.

⁹⁾ D = outputs overcurrent and short-circuit protected.

Current consumption	30 mA ³⁾
Switching output	PNP
Switching mode	Light/dark switching
Switching mode selector	Selectable via light/dark rotary switch
Signal voltage PNP HIGH/LOW	$U_V - 1,8 \text{ V} / \text{ca. } 0 \text{ V}$
Output current I_{max}	$\leq 100 \text{ mA}$
Response time	$< 0,25 \text{ ms}^4)$
Switching frequency	2,000 Hz ⁵⁾
Connection type	Cable with M12 male connector, 4-pin, 0,2 m ⁶⁾
Cable material	PUR
Conductor cross section	0,18 mm ²
Circuit protection	A ⁷⁾ B ⁸⁾ D ⁹⁾
Weight	50 g
Polarisation filter	✓
Special device	✓
Housing material	Plastic, ABS/PC/POM
Optics material	Plastic, PMMA
Enclosure rating	IP65
Items supplied	Stainless steel mounting bracket (1.4301/304) BEF-W100-A
Ambient operating temperature	-10 °C ... +50 °C
Ambient temperature, storage	-40 °C ... +70 °C

¹⁾ Limit values when operated in short-circuit protected network: max. 8 A.

²⁾ May not exceed or fall below U_V tolerances.

³⁾ Without load.

⁴⁾ Signal transit time with resistive load.

⁵⁾ With light/dark ratio 1:1.

⁶⁾ Do not bend below 0 °C.

⁷⁾ A = V_S connections reverse-polarity protected.

⁸⁾ B = inputs and output reverse-polarity protected.

⁹⁾ D = outputs overcurrent and short-circuit protected.

Safety-related parameters

MTTF_D	437.7 years
DC_{avg}	0 %

Classifications

ECLASS 5.0	27270902
ECLASS 5.1.4	27270902
ECLASS 6.0	27270902
ECLASS 6.2	27270902
ECLASS 7.0	27270902
ECLASS 8.0	27270902
ECLASS 8.1	27270902

ECLASS 9.0	27270902
ECLASS 10.0	27270902
ECLASS 11.0	27270902
ECLASS 12.0	27270901
ETIM 5.0	EC002717
ETIM 6.0	EC002717
ETIM 7.0	EC002717
ETIM 8.0	EC002717
UNSPSC 16.0901	39121528

Dimensional drawing (Dimensions in mm (inch))

WT100L, WL100L

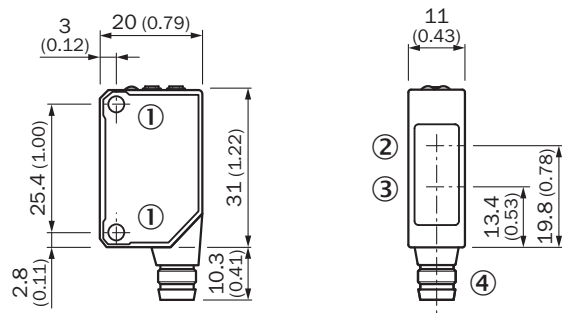

- ① Threaded mounting hole M3
- ② Center of optical axis, receiver
- ③ Center of optical axis, sender
- ④ Connection

Adjustments

WT100L, WL100L

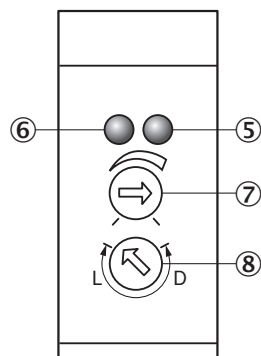

- ⑤ Orange LED indicator : switching output active
- ⑥ LED indicator green: power on
- ⑦ Sensing range (WT) / sensitivity (WL) adjustment: potentiometer, 270°
- ⑧ Light/ dark rotary switch: L = light switching, D = dark switching

Connection type

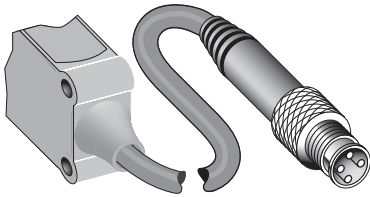

Connection diagram

Cd-066

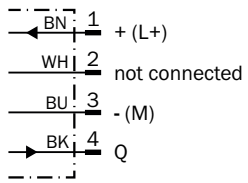

Characteristic curve

WL100L

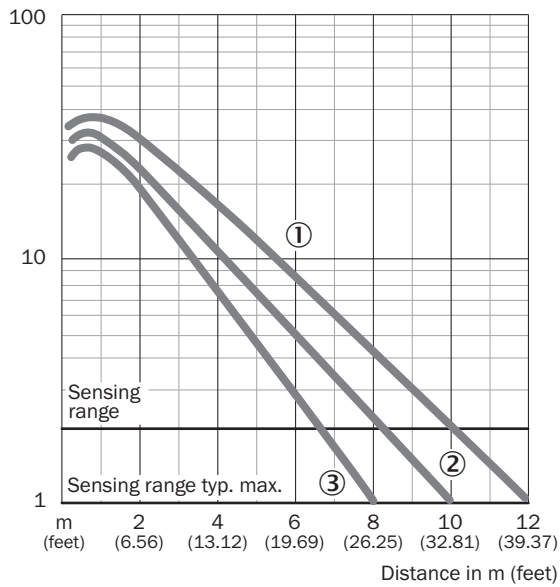

- ① Reflector P250F
- ② Reflector PL20F
- ③ PL10F reflector

Light spot size

WL100L

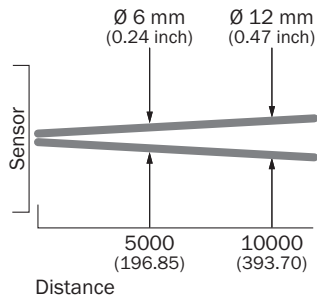

All dimensions in mm (feet)

Sensing range diagram

WL100L

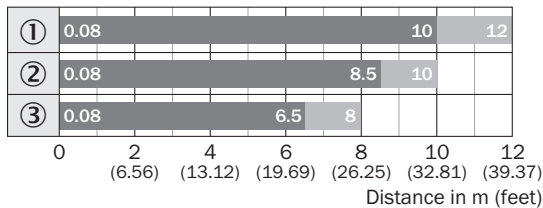





■ Sensing range ■ Sensing range max.

- ① Reflector P250F
- ② Reflector PL20F
- ③ PL10F reflector

Recommended accessories

Other models and accessories → www.sick.com/W100_Laser

	Brief description	Type	Part no.
Mounting brackets and plates			
	Universal mounting bracket for reflectors, steel, zinc coated	BEF-WN-REFX	2064574
Plug connectors and cables			
	<ul style="list-style-type: none"> • Connection type head A: Male connector, M12, 4-pin, straight • Description: Unshielded • Connection systems: Screw-type terminals • Permitted cross-section: ≤ 0.75 mm² 	STE-1204-G	6009932
Reflectors			
	Fine triple reflector, screw connection, suitable for laser sensors, 52 mm x 62 mm, PM-MA/ABS, Screw-on, 2 hole mounting	P250F	5308843

	Brief description	Type	Part no.
Others			
	<ul style="list-style-type: none"> • Connection type head A: Female connector, M12, 4-pin, straight, A-coded • Connection type head B: Flying leads • Signal type: Sensor/actuator cable • Cable: 5 m, 4-wire, PUR, halogen-free • Description: Sensor/actuator cable, unshielded • Application: Zones with oils and lubricants, Drag chain operation, Robot 	YF2A14-050UB3XLEAX	2095608

SICK AT A GLANCE

SICK is one of the leading manufacturers of intelligent sensors and sensor solutions for industrial applications. A unique range of products and services creates the perfect basis for controlling processes securely and efficiently, protecting individuals from accidents and preventing damage to the environment.

We have extensive experience in a wide range of industries and understand their processes and requirements. With intelligent sensors, we can deliver exactly what our customers need. In application centers in Europe, Asia and North America, system solutions are tested and optimized in accordance with customer specifications. All this makes us a reliable supplier and development partner.

Comprehensive services complete our offering: SICK LifeTime Services provide support throughout the machine life cycle and ensure safety and productivity.

For us, that is “Sensor Intelligence.”

WORLDWIDE PRESENCE:

Contacts and other locations –www.sick.com