



IMB12-04BNPVC0S

IMB

INDUCTIVE PROXIMITY SENSORS

SICK
Sensor Intelligence.



Illustration may differ



Ordering information

| Type | Part no. |
|-----------------|----------|
| IMB12-04BNPVC0S | 1074361 |

Included in delivery: BEF-MU-M12N (1)

Other models and accessories → www.sick.com/IMB

Detailed technical data

Features

| | |
|--|---|
| Housing | Cylindrical thread design |
| Housing | Standard design |
| Thread size | M12 x 1 |
| Diameter | Ø 12 mm |
| Sensing range S_n | 4 mm |
| Safe sensing range S_a | 3.24 mm |
| Installation type | Flush |
| Switching frequency | 2,000 Hz |
| Connection type | Male connector M12, 4-pin ¹⁾ |
| Switching output | NPN |
| Output function | Complementary |
| Electrical wiring | DC 4-wire |
| Enclosure rating | IP68 ²⁾ IP69K ³⁾ |
| Special features | Resistant against coolant lubricants, Temperature resistance |
| Special applications | Zones with coolants and lubricants, Mobile machines, Difficult application conditions |
| Items supplied | Mounting nut, V2A stainless steel, with locking teeth (2x) |

¹⁾ With gold plated contact pins.

²⁾ According to EN 60529.

³⁾ According to ISO 20653:2013-03.

Mechanics/electronics

| | |
|---|--|
| Supply voltage | 10 V DC ... 30 V DC |
| Ripple | ≤ 10 % |
| Voltage drop | ≤ 2 V ¹⁾ |
| Hysteresis | 3 % ... 20 % |
| Reproducibility | ≤ 2 % ^{2) 3)} |
| Temperature drift (of S_r) | ± 10 % |
| EMC | According to EN 60947-5-2 |
| Continuous current I_a | ≤ 200 mA |
| No load current | ≤ 10 mA |
| Short-circuit protection | ✓ |
| Reverse polarity protection | ✓ |
| Power-up pulse protection | ✓ |
| Shock and vibration resistance | 100 g / 2 ms / 500 cycles; 150 g / 1 Mio cycles; 10 Hz ... 55 Hz / 1 mm; 55 Hz ... 500 Hz / 60 g |
| Ambient operating temperature | -40 °C ... +100 °C |
| Housing material | Stainless steel V2A, DIN 1.4305 / AISI 303 |
| Sensing face material | Plastic, LCP |
| Housing length | 65 mm |
| Thread length | 48 mm |
| Tightening torque, max. | Typ. 20 Nm ⁴⁾ Typ. 32 Nm ⁵⁾ |
| Protection class | III |
| UL File No. | E181493 |

¹⁾ At I_a max.

²⁾ Supply voltage U_B and constant ambient temperature T_a.

³⁾ Of S_r.

⁴⁾ When using the non-toothed side of the nut.

⁵⁾ Valid if toothed side of nut is used.

Safety-related parameters

| | |
|-------------------------|-------------|
| MTTF_D | 2,016 years |
| DC_{avg} | 0 % |

Reduction factors

| | |
|-----------------------------------|--|
| Note | The values are reference values which may vary |
| St37 steel (Fe) | 1 |
| Stainless steel (V2A, 304) | Approx. 0.65 |
| Aluminum (Al) | Approx. 0.35 |
| Copper (Cu) | Approx. 0.24 |
| Brass (Br) | Approx. 0.38 |

Installation note

| | |
|---------------|---------------------------------------|
| Remark | Associated graphic see "Installation" |
| B | 12 mm |

| | |
|----------|-------|
| C | 12 mm |
| D | 12 mm |
| F | 32 mm |

Classifications

| | |
|-----------------------|----------|
| ECLASS 5.0 | 27270101 |
| ECLASS 5.1.4 | 27270101 |
| ECLASS 6.0 | 27270101 |
| ECLASS 6.2 | 27270101 |
| ECLASS 7.0 | 27270101 |
| ECLASS 8.0 | 27270101 |
| ECLASS 8.1 | 27270101 |
| ECLASS 9.0 | 27270101 |
| ECLASS 10.0 | 27270101 |
| ECLASS 11.0 | 27270101 |
| ECLASS 12.0 | 27274001 |
| ETIM 5.0 | EC002714 |
| ETIM 6.0 | EC002714 |
| ETIM 7.0 | EC002714 |
| ETIM 8.0 | EC002714 |
| UNSPSC 16.0901 | 39122230 |

Installation note

Flush installation

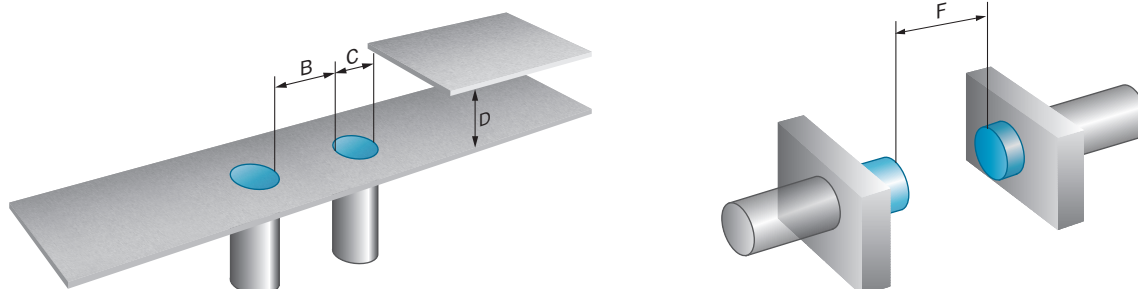

Connection diagram

Cd-006

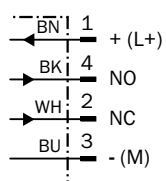

Response diagram

Response diagram

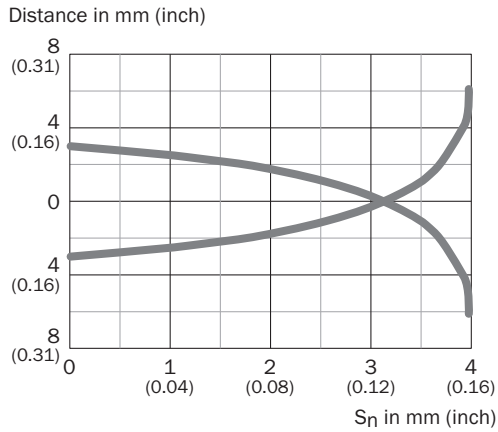

Dimensional drawing (Dimensions in mm (inch))

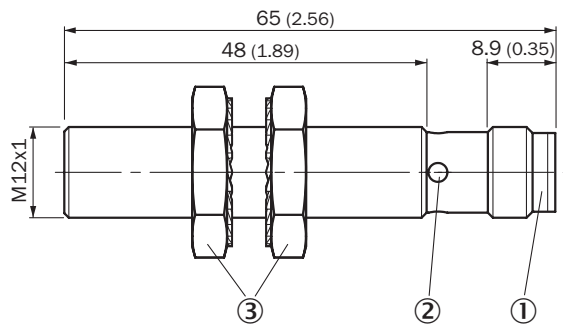

IMB12 Standard, connector, M12, flush









- ① Connection
- ② Display LED
- ③ Fastening nuts (2 x); width across 17, stainless steel V2A



Recommended accessories

Other models and accessories → www.sick.com/IMB

| | Brief description | Type | Part no. |
|---|---|--------------|----------|
| Universal bar clamp systems | | | |
|  | Plate N05N for universal clamp bracket, M12, Stainless steel 1.4571 (sheet), Stainless steel 1.4408 (clamp), Universal clamp (5322627), mounting hardware | BEF-KHS-N05N | 2051621 |
| Mounting brackets and plates | | | |
|  | Mounting plate for M12 sensors, stainless steel, without mounting hardware | BEF-WG-M12N | 5320950 |

| | Brief description | Type | Part no. |
|---|--|-----------------|----------|
|  | Mounting bracket for M12 housing, stainless steel, without mounting hardware | BEF-WN-M12N | 5320949 |
| Others | | | |
|  | <ul style="list-style-type: none"> • Connection type head A: Female connector, M12, 4-pin, straight • Connection type head B: Flying leads • Signal type: Sensor/actuator cable • Cable: 2 m, 4-wire, PP • Description: Sensor/actuator cable, unshielded • Connection systems: Flying leads • Note: This product is generally resistant to chemical cleaning agents (see ECOLAB) and other chemical compounds such as H2O2 and CH2O2. Before permanent installation is carried out, the material's resistance to the cleaning agent being used must be checked., Resistant against lactic acid & hydrogen peroxide (H2O2) • Application: Hygienic and washdown zones, Drag chain operation | DOL-1204-G02MRN | 6058291 |
|  | <ul style="list-style-type: none"> • Connection type head A: Female connector, M12, 4-pin, straight • Connection type head B: Flying leads • Signal type: Sensor/actuator cable • Cable: 5 m, 4-wire, PP • Description: Sensor/actuator cable, unshielded • Connection systems: Flying leads • Note: This product is generally resistant to chemical cleaning agents (see ECOLAB) and other chemical compounds such as H2O2 and CH2O2. Before permanent installation is carried out, the material's resistance to the cleaning agent being used must be checked., Resistant against lactic acid & hydrogen peroxide (H2O2) • Application: Hygienic and washdown zones, Drag chain operation | DOL-1204-G05MRN | 6058476 |
|  | <ul style="list-style-type: none"> • Connection type head A: Female connector, M12, 4-pin, angled • Connection type head B: Flying leads • Signal type: Sensor/actuator cable • Cable: 2 m, 4-wire, PP • Description: Sensor/actuator cable, unshielded, LED function display • Connection systems: Flying leads • Note: This product is generally resistant to chemical cleaning agents (see ECOLAB) and other chemical compounds such as H2O2 and CH2O2. Before permanent installation is carried out, the material's resistance to the cleaning agent being used must be checked., Resistant against lactic acid & hydrogen peroxide (H2O2), only suitable for PNP sensors • Application: Hygienic and washdown zones, Drag chain operation | DOL-1204-L02MRN | 6058482 |
|  | <ul style="list-style-type: none"> • Connection type head A: Female connector, M12, 4-pin, angled • Connection type head B: Flying leads • Signal type: Sensor/actuator cable • Cable: 5 m, 4-wire, PP • Description: Sensor/actuator cable, unshielded, LED function display • Connection systems: Flying leads • Note: This product is generally resistant to chemical cleaning agents (see ECOLAB) and other chemical compounds such as H2O2 and CH2O2. Before permanent installation is carried out, the material's resistance to the cleaning agent being used must be checked., Resistant against lactic acid & hydrogen peroxide (H2O2), only suitable for PNP sensors • Application: Hygienic and washdown zones, Drag chain operation | DOL-1204-L05MRN | 6058483 |
|  | <ul style="list-style-type: none"> • Connection type head A: Female connector, M12, 4-pin, angled • Connection type head B: Flying leads • Signal type: Sensor/actuator cable • Cable: 2 m, 4-wire, PP • Description: Sensor/actuator cable, unshielded • Connection systems: Flying leads • Note: This product is generally resistant to chemical cleaning agents (see ECOLAB) and other chemical compounds such as H2O2 and CH2O2. Before permanent installation is carried out, the material's resistance to the cleaning agent being used must be checked., Resistant against lactic acid & hydrogen peroxide (H2O2) • Application: Hygienic and washdown zones, Drag chain operation | DOL-1204-W02MRN | 6058474 |

| | Brief description | Type | Part no. |
|---|---|--------------------|----------|
|  | <ul style="list-style-type: none"> • Connection type head A: Female connector, M12, 4-pin, angled • Connection type head B: Flying leads • Signal type: Sensor/actuator cable • Cable: 5 m, 4-wire, PP • Description: Sensor/actuator cable, unshielded • Connection systems: Flying leads • Note: This product is generally resistant to chemical cleaning agents (see ECOLAB) and other chemical compounds such as H2O2 and CH2O2. Before permanent installation is carried out, the material's resistance to the cleaning agent being used must be checked., Resistant against lactic acid & hydrogen peroxide (H2O2) • Application: Hygienic and washdown zones, Drag chain operation | DOL-1204-W05MRN | 6058477 |
|  | <ul style="list-style-type: none"> • Connection type head A: Female connector, M12, 4-pin, angled • Connection type head B: Male connector, M12, 4-pin, straight • Signal type: Sensor/actuator cable • Cable: 2 m, 4-wire, PP • Description: Sensor/actuator cable, unshielded • Note: This product is generally resistant to chemical cleaning agents (see ECOLAB) and other chemical compounds such as H2O2 and CH2O2. Before permanent installation is carried out, the material's resistance to the cleaning agent being used must be checked., Resistant against lactic acid & hydrogen peroxide (H2O2) • Application: Hygienic and washdown zones, Drag chain operation | DSL-1204-B02MRN | 6058502 |
|  | <ul style="list-style-type: none"> • Connection type head A: Female connector, M12, 4-pin, angled • Connection type head B: Male connector, M12, 4-pin, straight • Signal type: Sensor/actuator cable • Cable: 5 m, 4-wire, PP • Description: Sensor/actuator cable, unshielded • Note: This product is generally resistant to chemical cleaning agents (see ECOLAB) and other chemical compounds such as H2O2 and CH2O2. Before permanent installation is carried out, the material's resistance to the cleaning agent being used must be checked., Resistant against lactic acid & hydrogen peroxide (H2O2) • Application: Hygienic and washdown zones, Drag chain operation | DSL-1204-B05MRN | 6058503 |
|  | <ul style="list-style-type: none"> • Connection type head A: Female connector, M12, 4-pin, straight • Connection type head B: Male connector, M12, 4-pin, straight • Signal type: Sensor/actuator cable • Cable: 2 m, 4-wire, PP • Description: Sensor/actuator cable, unshielded • Note: This product is generally resistant to chemical cleaning agents (see ECOLAB) and other chemical compounds such as H2O2 and CH2O2. Before permanent installation is carried out, the material's resistance to the cleaning agent being used must be checked., Resistant against lactic acid & hydrogen peroxide (H2O2) • Application: Hygienic and washdown zones, Drag chain operation | DSL-1204-G02MRN | 6058499 |
|  | <ul style="list-style-type: none"> • Connection type head A: Female connector, M12, 4-pin, straight • Connection type head B: Male connector, M12, 4-pin, straight • Signal type: Sensor/actuator cable • Cable: 5 m, 4-wire, PP • Description: Sensor/actuator cable, unshielded • Note: This product is generally resistant to chemical cleaning agents (see ECOLAB) and other chemical compounds such as H2O2 and CH2O2. Before permanent installation is carried out, the material's resistance to the cleaning agent being used must be checked., Resistant against lactic acid & hydrogen peroxide (H2O2) • Application: Hygienic and washdown zones, Drag chain operation | DSL-1204-G05MRN | 6058500 |
|  | <ul style="list-style-type: none"> • Connection type head A: Female connector, M12, 4-pin, straight, A-coded • Connection type head B: Male connector, M12, 4-pin, straight, A-coded • Signal type: Sensor/actuator cable • Cable: 5 m, 4-wire, PUR, halogen-free • Description: Sensor/actuator cable, unshielded • Application: Zones with oils and lubricants, Drag chain operation, Robot | YF2A14-050UB3M2A14 | 2096001 |
|  | <ul style="list-style-type: none"> • Connection type head A: Female connector, M12, 4-pin, straight, A-coded • Connection type head B: Flying leads • Signal type: Sensor/actuator cable • Cable: 2 m, 4-wire, PUR, halogen-free • Description: Sensor/actuator cable, unshielded • Application: Zones with oils and lubricants, Drag chain operation, Robot | YF2A14-020UB3XLEAX | 2095607 |

| | Brief description | Type | Part no. |
|---|--|--------------------|----------|
|  | <ul style="list-style-type: none"> • Connection type head A: Female connector, M12, 4-pin, straight, A-coded • Connection type head B: Flying leads • Signal type: Sensor/actuator cable • Cable: 5 m, 4-wire, PUR, halogen-free • Description: Sensor/actuator cable, unshielded • Application: Zones with oils and lubricants, Drag chain operation, Robot | YF2A14-050UB3XLEAX | 2095608 |
|  | <ul style="list-style-type: none"> • Connection type head A: Female connector, M12, 4-pin, angled, A-coded • Connection type head B: Flying leads • Signal type: Sensor/actuator cable • Cable: 5 m, 4-wire, PUR, halogen-free • Description: Sensor/actuator cable, unshielded • Application: Zones with oils and lubricants, Drag chain operation, Robot | YG2A14-050UB3XLEAX | 2095767 |

SICK AT A GLANCE

SICK is one of the leading manufacturers of intelligent sensors and sensor solutions for industrial applications. A unique range of products and services creates the perfect basis for controlling processes securely and efficiently, protecting individuals from accidents and preventing damage to the environment.

We have extensive experience in a wide range of industries and understand their processes and requirements. With intelligent sensors, we can deliver exactly what our customers need. In application centers in Europe, Asia and North America, system solutions are tested and optimized in accordance with customer specifications. All this makes us a reliable supplier and development partner.

Comprehensive services complete our offering: SICK LifeTime Services provide support throughout the machine life cycle and ensure safety and productivity.

For us, that is “Sensor Intelligence.”

WORLDWIDE PRESENCE:

Contacts and other locations –www.sick.com