

Product designation				Enclosed rotary cam switch
Product type designation				GN200
<b>General characteristics</b>				
Switching diagram				92 - ON/OFF switch 4 poles
N° of elements				2
Mounting form				L - Metal enclosure with black handle
<b>Contact characteristics</b>				
Rated insulation voltage $U_i$	IEC/EN	V	690	
	UL/CSA	V	600	
Rated impulse withstand voltage $U_{imp}$		kV	8	
Conventional free air thermal current $I_{th}$	IEC/EN	A	200	
	UL/CSA	A	200	
Rated operational voltage		V	690	
Rated operational impulse voltage		kV	6	
Maximum fuse size for short-circuit protection $I_n$ (gG)	10kA	A	200	
	15kA	A	200	
Rated short time current $I_{cw}$		1s	A	3300
Operational current $I_e$ IEC/EN AC1/AC21A		A	200	
Rated operational power in AC Three-phase AC-3	220/230V	kW	27.5	
	380/440V	kW	47	
Rated operational current in DC DC21A	48V	A	200	
	60V	A	200	
	110V	A	35	
	220V	A	2.5	
	440V	A	0.9	
Power dissipation		W	26	
<b>Mechanical features</b>				
Terminals screw				M10
Tightening torque for terminals max				Nm 10
Conductor size	AWG - Rigid cable	Max	AWG	1X3
	AWG - Flexible cable	Max	AWG	0
	Conductor size (IEC) - Flexible cable	Max	mm <sup>2</sup>	1X95
Conductor size (IEC) - Rigid cable	Max	mm <sup>2</sup>	1X95	
Mechanical life				cycles 2X10 <sup>5</sup>

**UL technical data**

Motor power for direct-on-line control

for three-phase motor

120V	HP	30
240V	HP	50
480V	HP	100
600V	HP	75

for single-phase motor

120V	HP	15
240V	HP	30

**Ambient conditions**

Temperature

Operating temperature

min	°C	-25
max	°C	+55

Storage temperature

min	°C	-40
max	°C	+70

**Resistance & Protection**

Frontal IP degree

IP54

Terminals IP degree

IP00

**Dimensions**

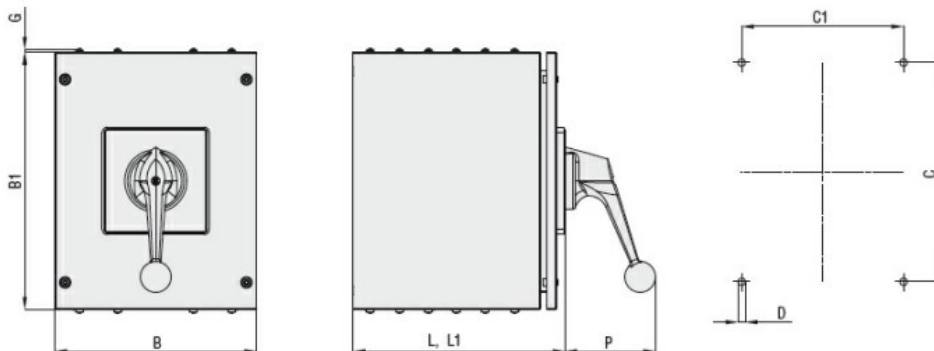

Series	Enclosure size	Number of elements		Dimensions									Protection degree
		L	L1	L	L1	B	B1	C	C1	D	G	P	
GN200	250x316	1 - 3	4 - 6	162	252	250	316	270	200	9	4.5	98	IP54
GN315		1 - 3	4 - 6	162	252	250	316	270	200	9	4.5	98	IP54

**Wiring diagrams**

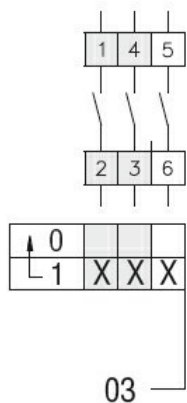

**Certifications and compliance**

Compliance

IEC/EN/BS 60947-1

---

IEC/EN/BS 60947-3

---

IEC/EN/BS 60947-5-1

ETIM classification

ETIM 8.0

EC001029 -  
Selector switch,  
complete