



IMA18-08NE1ZW2S

IMA

INDUCTIVE PROXIMITY SENSORS

SICK
Sensor Intelligence.



Ordering information

Type	Part no.
IMA18-08NE1ZW2S	1105020

Other models and accessories → www.sick.com/IMA

Illustration may differ



Detailed technical data

Features

Housing	Cylindrical thread design
Thread size	M18 x 1
Diameter	Ø 18 mm
Sensing range S_n	0 mm ... 8 mm
Installation type	Non-flush
Connection type	Cable, 4-wire, 2 m
Output function	Analog
Repeatability (T_a not constant)	0.3 mm ^{1) 2) 3)}
Repeatability (T_a constant)	± 0.1 mm
Enclosure rating	IP67 ⁴⁾
Special features	Analog output
Items supplied	Mounting nut, brass, chromium-plated (2x)

¹⁾ As per IEC 60947-5-2.

²⁾ $U_b = DC 20 V \dots 30 V$.

³⁾ $T_A = 23 \text{ °C} \pm 5 \text{ °C}$.

⁴⁾ According to EN 60529: 2000-09.

Mechanics/electronics

Supply voltage	15 V DC ... 30 V DC
Ripple	≤ 20 % ¹⁾
Time delay before availability	≤ 30 ms
Temperature drift (of S_n)	≤ 10 %

¹⁾ Of V_S .

²⁾ Without load.

³⁾ -3 dB if $S_n = 4 \text{ mm}$.

⁴⁾ QA1 loaded, QA2 unloaded.

⁵⁾ QA1 loaded, QA2 loaded: see temperature reduction.

No load current	$\leq 12 \text{ mA}^{2)}$
Max. load resistance on Q_{A1}	$\geq 2 \text{ k}\Omega$
Max. load resistance on Q_{A2}	$400 \Omega \text{ Ub} = 15 \text{ V}$
Output voltage Q_{A1}	s = 0 mm: 0 V -0/+0,6 V (23 °C) s = 4 mm: 5,6 V +/-0,6 V (23 °C) s = 8 mm: 10 V +/-0,6 V (23 °C)
Output current Q_{A2}	s = 0 mm: 4 mA +/-0,8 mA (23 °C) s = 8 mm: 20 mA +/-0,8 mA (23 °C)
Output voltage	0 V ... 10 V
Output current	4 mA ... 20 mA
Bandwidth	500 Hz ³⁾
Short-circuit protection	✓
Reverse polarity protection	✓
Ambient operating temperature	-25 °C ... +70 °C ^{4) 5)}
Housing material	Brass, chromium-plated
Sensing face material	Plastic
Housing length	67 mm
Thread length	42 mm

1) Of V_S.

2) Without load.

3) -3 dB if S_n = 4 mm.

4) QA1 loaded, QA2 unloaded.

5) QA1 loaded, QA2 loaded: see temperature reduction.

Safety-related parameters

MTTF_D	1,149 years
DC_{avg}	0 %
T_M (mission time)	20 years

Installation note

Remark	Associated graphic see "Installation"
A	18 mm
B	36 mm
C	18 mm
D	24 mm
E	16 mm
F	64 mm

Classifications

ECLASS 5.0	27270101
ECLASS 5.1.4	27270101
ECLASS 6.0	27270101
ECLASS 6.2	27270101
ECLASS 7.0	27270101
ECLASS 8.0	27270101

ECLASS 8.1	27270101
ECLASS 9.0	27270101
ECLASS 10.0	27270101
ECLASS 11.0	27270101
ECLASS 12.0	27274001
ETIM 5.0	EC002714
ETIM 6.0	EC002714
ETIM 7.0	EC002714
ETIM 8.0	EC002714
UNSPSC 16.0901	39122230

Installation note

Non-flush installation

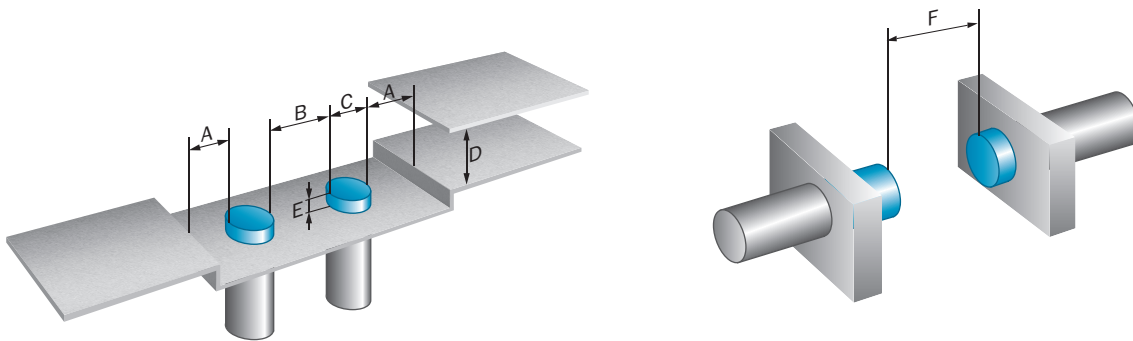

Connection diagram

Cd-022

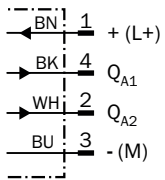

Temperature derating

Temperature derating

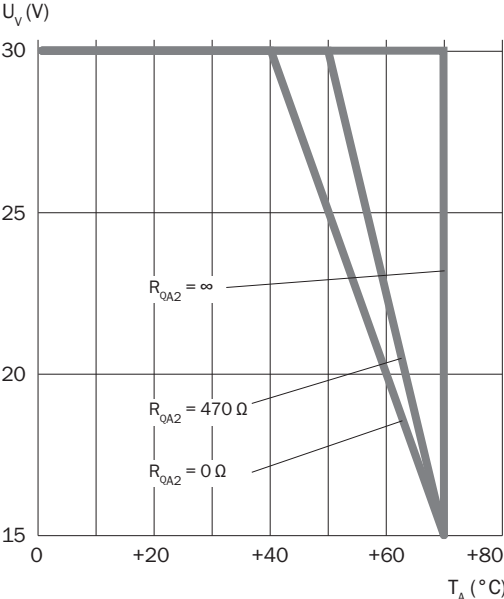

Response diagram

Reduction factors

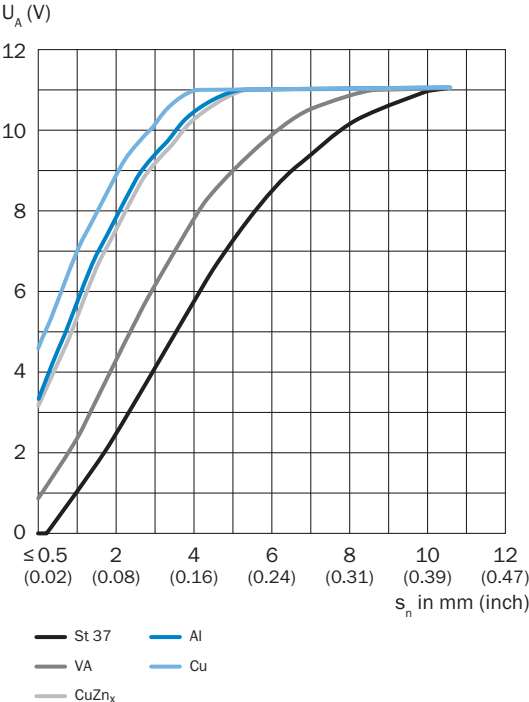

Output current

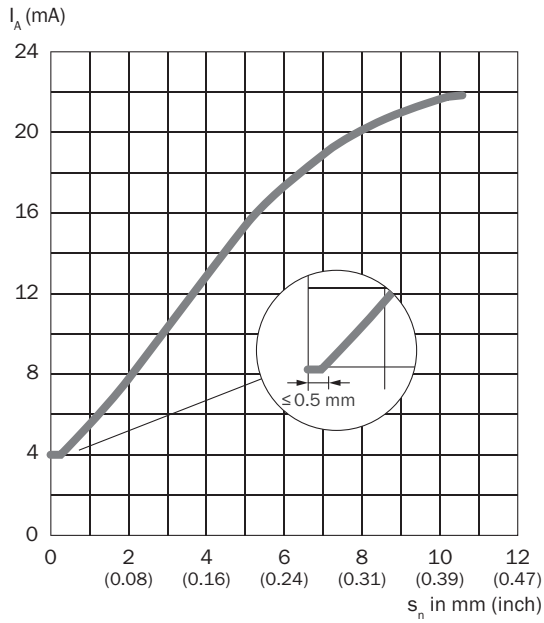

Output voltage

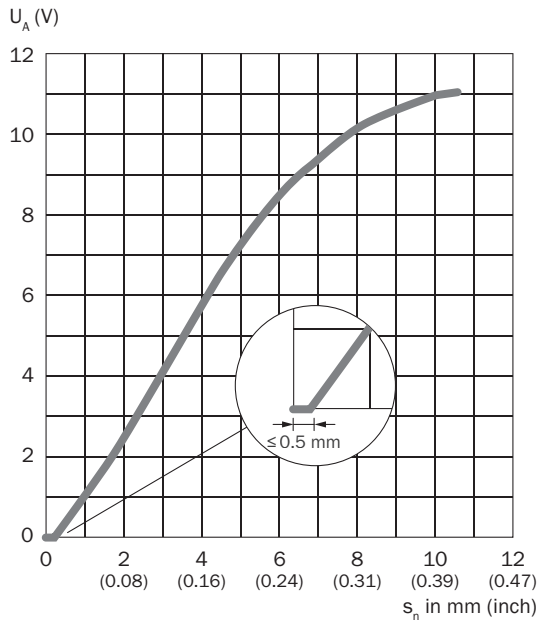

Dimensional drawing (Dimensions in mm (inch))



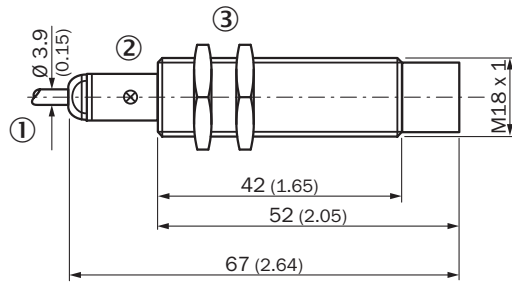

IMA18 Standard, cable, non-flush





- ① Connection
- ② Display LED
- ③ Fastening nuts (2x); width across 24, metal

Recommended accessories

Other models and accessories → www.sick.com/IMA

	Brief description	Type	Part no.
Universal bar clamp systems			
	Plate N06 for universal clamp bracket, M18, Zinc plated steel (sheet), Zinc die cast (clamping bracket), Universal clamp (5322626), mounting hardware	BEF-KHS-N06	2051612
Mounting brackets and plates			
	Mounting bracket for M18 sensors, steel, zinc coated, without mounting hardware	BEF-WN-M18	5308446
Terminal and alignment brackets			
	Mounting bracket with ball-and-socket, plastic, mounting hardware included	BEF-WN-M18-ST02	5312973
	Clamping block for round sensors M18, without fixed stop, plastic (PA12), glass-fiber reinforced, mounting hardware included	BEF-KH-M18	2051481
	Clamping block for round sensors M18, with fixed stop, plastic (PA12), glass-fiber reinforced, mounting hardware included	BEF-KHF-M18	2051482
Others			
	<ul style="list-style-type: none"> • Connection type head A: Female connector, M12, 4-pin, straight, A-coded • Connection type head B: Flying leads • Signal type: Sensor/actuator cable • Cable: 2 m, 4-wire, PVC • Description: Sensor/actuator cable, unshielded • Application: Zones with chemicals 	YF2A14-020VB3XLEAX	2096234
	<ul style="list-style-type: none"> • Connection type head A: Female connector, M12, 4-pin, straight, A-coded • Connection type head B: Flying leads • Signal type: Sensor/actuator cable • Cable: 5 m, 4-wire, PVC • Description: Sensor/actuator cable, unshielded • Application: Zones with chemicals 	YF2A14-050VB3XLEAX	2096235

	Brief description	Type	Part no.
	<ul style="list-style-type: none"> • Connection type head A: Female connector, M12, 4-pin, angled, A-coded • Connection type head B: Flying leads • Signal type: Sensor/actuator cable • Cable: 2 m, 4-wire, PVC • Description: Sensor/actuator cable, unshielded • Application: Zones with chemicals 	YG2A14-020VB3XLEAX	2095895
	<ul style="list-style-type: none"> • Connection type head A: Female connector, M12, 4-pin, angled, A-coded • Connection type head B: Flying leads • Signal type: Sensor/actuator cable • Cable: 5 m, 4-wire, PVC • Description: Sensor/actuator cable, unshielded • Application: Zones with chemicals 	YG2A14-050VB3XLEAX	2095897

SICK AT A GLANCE

SICK is one of the leading manufacturers of intelligent sensors and sensor solutions for industrial applications. A unique range of products and services creates the perfect basis for controlling processes securely and efficiently, protecting individuals from accidents and preventing damage to the environment.

We have extensive experience in a wide range of industries and understand their processes and requirements. With intelligent sensors, we can deliver exactly what our customers need. In application centers in Europe, Asia and North America, system solutions are tested and optimized in accordance with customer specifications. All this makes us a reliable supplier and development partner.

Comprehensive services complete our offering: SICK LifeTime Services provide support throughout the machine life cycle and ensure safety and productivity.

For us, that is “Sensor Intelligence.”

WORLDWIDE PRESENCE:

Contacts and other locations –www.sick.com