

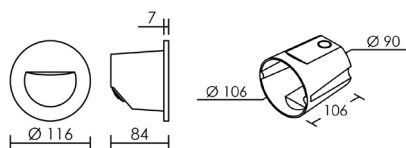











	<h1>Murena R</h1>			Code / Réf
				51345
				51349

220-240V~ 50/60Hz	1.7W	CCT 3000-4000K		IP65	IK07	 0.54							
----------------------	------	-------------------	---	------	------	--	---	--	---	---	---	---	---

FR	 Ne jetez pas vos déchets électriques avec les déchets ménagers. Confiez votre appareil à votre centre de recyclage pour son traitement approprié.	 Suivez la fiche d'instructions pour garantir un fonctionnement fiable et sécurisé. À conserver pour consultation ultérieure. Les produits doivent être installés par un électricien qualifié conformément aux normes internationales de câblage.
EN	Waste electrical products must not be disposed of with household waste. This tool should be taken to your recycling center for safe treatment.	Follow Instruction Sheet to ensure safe and reliable operation. Retain for future reference. Products should be installed by a qualified Electrician in accordance with International Wiring Regulations.
DE	Dieses Gerät darf nicht mit dem Hausmüll/Restmüll entsorgt werden. Das Altgerät nur in einer öffentlichen Sammelstelle abgeben.	Die Gebrauchsanweisung befolgen, damit der sichere und zuverlässige Betrieb gewährleistet ist. Zum späteren Nachschlagen aufheben. Die Produkte müssen von einem qualifizierten Elektriker in Übereinstimmung mit den relevanten Vorschriften installiert werden.
IT	I rifiuti elettrici non devono essere smaltiti con i rifiuti domestici. Questo strumento deve essere portato al centro di riciclaggio per un trattamento sicuro.	Seguire il foglio delle istruzioni per garantire il funzionamento sicuro e affidabile. Conservare per riferimento futuro. I prodotti devono essere installati da un elettricista qualificato conformemente alle normative internazionali sui cablaggi.
ES	Los productos eléctricos de desecho no deben ser eliminados con residuos domésticos. Esta herramienta debe ser llevada a su centro de reciclaje para un tratamiento seguro.	Siga la hoja de instrucciones para garantizar la seguridad y un funcionamiento fiable. Consérvela para utilizarla como material de referencia en el futuro. Los productos los debe instalar un técnico electricista cualificado en virtud de las normativas internacionales en materia de cableado.

FR	 La source lumineuse contenue dans ce luminaire ne doit être remplacée que par un employé de Aric, un agent ou une personne qualifiée.
EN	The light source contained in this luminaire must only be replaced by an Aric employee, an agent or a qualified person.
DE	Die Lichtquelle in dieser Leuchte darf nur durch einen Aric-Angestellten, einen Agenten oder eine qualifizierte Person ersetzt werden.
IT	La sorgente luminosa contenuta in questo apparecchio deve essere sostituita soltanto da un dipendente di Aric, da un agente o da una persona qualificata.
ES	La fuente luminosa contenida en esta luminaria sólo será sustituida por un empleado de Aric, un agente o una persona cualificada.

FR	Ce produit contient une source lumineuse de classe d'efficacité énergétique		
EN	This product contains a light source of energy efficiency class		
DE	Dieses Produkt enthält eine Lichtquelle der Energieeffizienzklasse		
IT	Questo prodotto contiene una sorgente luminosa di classe di efficienza energetica		
ES	Este producto contiene una fuente luminosa de la clase de eficiencia energética		

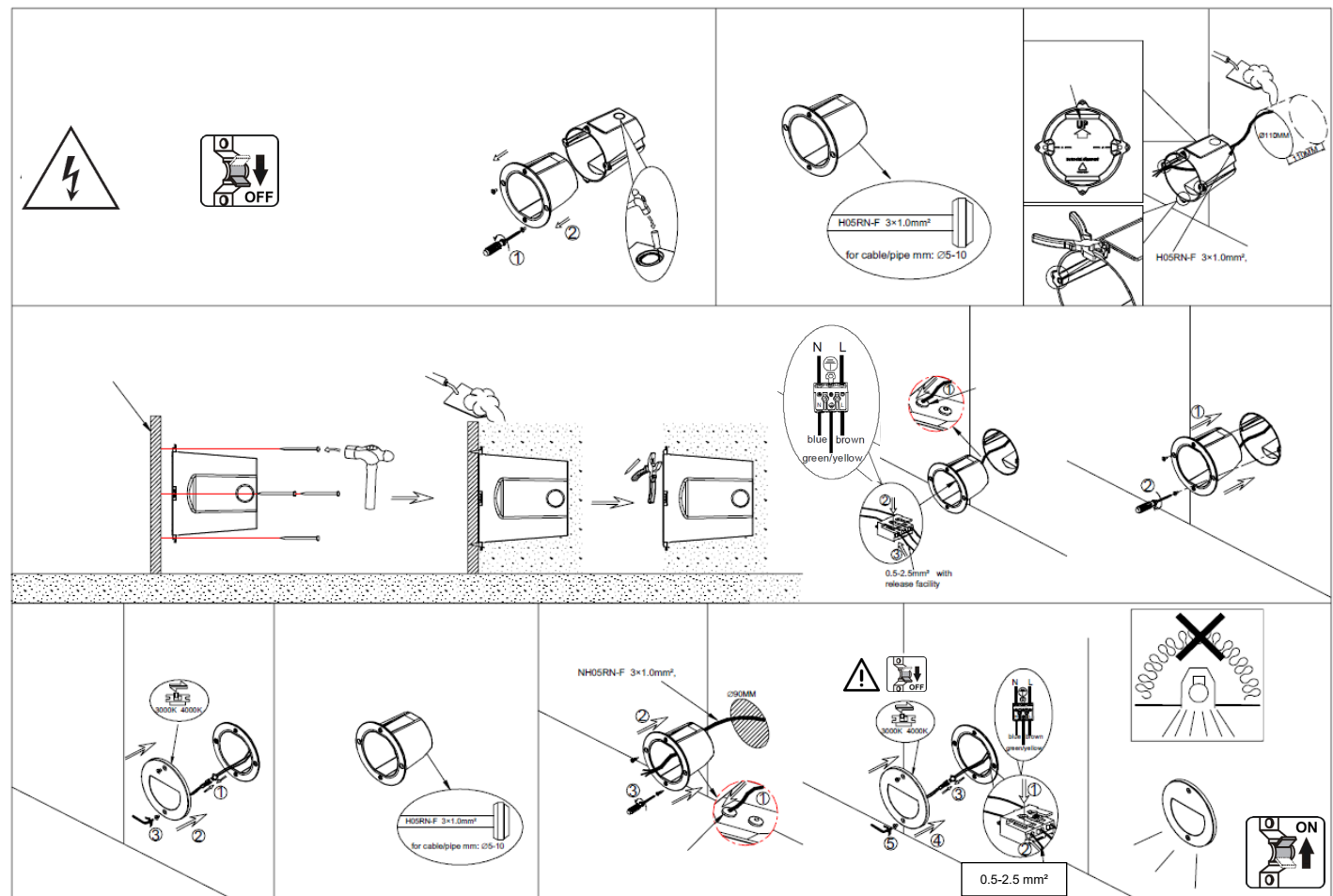

Wiring Diagram:
 N (blue)
 L (brown)
 green/yellow (ground)

Tools and Components:
 H05RN-F 3x1.0mm² for cable/pipe mm: Ø5-10
 0.5-2.5mm² with release facility

Warnings:
 ⚠️ Electricity symbol
 ⚠️ Switch OFF symbol
 ⚠️ No standard bulb symbol