

Part number
CHI 10



Bulkhead mounting housing, C-TYPE series,
with 2 levers, size "57.27"

Product description

Product type	Bulkhead mounting housing
Series	C-TYPE
Closing type	With 2 levers
Size	Size "57.27"

Technical data

IP degree of protection	IP66 (and IP69 DIN 40050 - 9)
--------------------------------	-------------------------------

Further technical details

Weight	157,50 g
Operating temperature range (min, max)	-40°C...+125°C

Material properties

Colour	RAL 7040 grey
RoHs conformity	Compliant
China RoHs - EFUP	E
REACH SVHC substances	No

Approvals / Standards

Certifications	DNV-GL, BV
UL	ECBT2
cUL	ECBT8

General ordering information

EAN13 code	8015747017398
eCl@ss 8.1	27440202
ETIM 7.0	EC000437

Packaging Information

Packaging length	380,00 mm
Packaging height	230,00 mm
Packaging width	290,00 mm
Packaging weight	6,94 kg
Packaging volume	25,35 dm ³
Packaging description	Carton box
Packaging quantity	40 Pcs
Packaging EAN code	8015747017404
Sub-packaging weight	0,87 kg
Sub-packaging description	Plastic packaging
Sub-packaging quantity	5 Pcs
Sub-packaging EAN barcode	8015747017411

Part number
CHI 10



Catalogue drawings

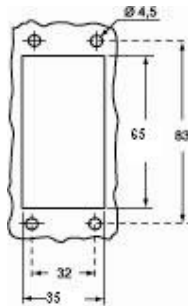

Catalogue drawings

CHI

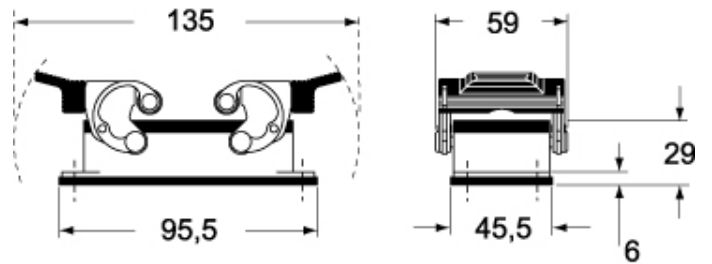

CHI C

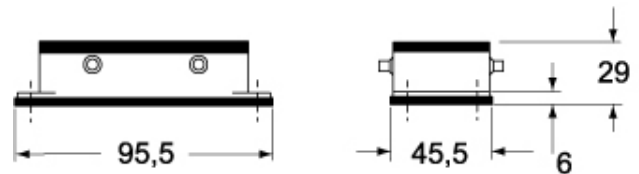

CHI CS/CP

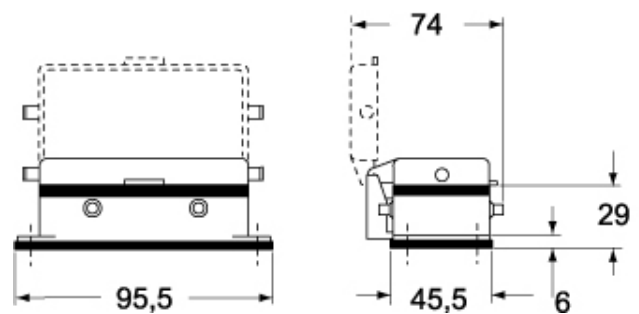

Notes

Dimensions shown in mm are not binding and may be changed without notice.