



Product designation				Power contactor
Product type designation				BF115
<b>Contact characteristics</b>				
Number of poles	Nr.			3
Rated insulation voltage $U_i$ IEC/EN	V			1000
Rated impulse withstand voltage $U_{imp}$	kV			8
Operational frequency	min	Hz	25	
	max	Hz	400	
IEC Conventional free air thermal current $I_{th}$	A			160
Operational current $I_e$	AC-1 ( $\leq 40^\circ\text{C}$ )	A	160	
	AC-1 ( $\leq 55^\circ\text{C}$ )	A	130	
	AC-1 ( $\leq 70^\circ\text{C}$ )	A	115	
	AC-3 ( $\leq 440\text{V} \leq 55^\circ\text{C}$ )	A	115	
	AC-4 (400V)	A	54	
Rated operational power AC-3 ( $T \leq 55^\circ\text{C}$ )	230V	kW	37	
	400V	kW	55	
	415V	kW	55	
	440V	kW	55	
	500V	kW	75	
	690V	kW	110	
	1000V	kW	55	
Rated operational current AC-3 ( $T \leq 55^\circ\text{C}$ )	230V	A	115	
	400V	A	115	
	415V	A	115	
	440V	A	115	
	500V	A	106	
	690V	A	106	
	1000V	A	39	
IEC max current $I_e$ in DC1 with $L/R \leq 1\text{ms}$ with 1 poles in series	$\leq 24\text{V}$	A	160	
	48V	A	160	
	75V	A	120	
	110V	A	10	
	220V	A	-	
IEC max current $I_e$ in DC1 with $L/R \leq 1\text{ms}$ with 2 poles in series	$\leq 24\text{V}$	A	160	
	48V	A	160	
	75V	A	160	
	110V	A	130	
	220V	A	14	
IEC max current $I_e$ in DC1 with $L/R \leq 1\text{ms}$ with 3 poles in series				

	≤24V	A	160
	48V	A	160
	75V	A	160
	110V	A	140
	220V	A	145
<hr/>			
IEC max current Ie in DC1 with L/R ≤ 1ms with 4 poles in series	≤24V	A	160
	48V	A	160
	75V	A	160
	110V	A	160
	220V	A	160
<hr/>			
IEC max current Ie in DC3-DC5 with L/R ≤ 15ms with 1 poles in series	≤24V	A	160
	48V	A	50
	75V	A	40
	110V	A	6
	220V	A	–
<hr/>			
IEC max current Ie in DC3-DC5 with L/R ≤ 15ms with 2 poles in series	≤24V	A	160
	48V	A	72
	75V	A	65
	110V	A	65
	220V	A	7
<hr/>			
IEC max current Ie in DC3-DC5 with L/R ≤ 15ms with 3 poles in series	≤24V	A	160
	48V	A	150
	75V	A	100
	110V	A	100
	220V	A	92
<hr/>			
IEC max current Ie in DC3-DC5 with L/R ≤ 15ms with 4 poles in series	≤24V	A	160
	48V	A	120
	75V	A	120
	110V	A	125
	220V	A	115
<hr/>			
Short-time allowable current for 10s (IEC/EN60947-1)		A	920
<hr/>			
Protection fuse	gG (IEC)	A	200
	aM (IEC)	A	125
<hr/>			
Making capacity (RMS value)		A	1500
<hr/>			
Breaking capacity at voltage	440V	A	1200
	500V	A	850
	690V	A	905
<hr/>			
Resistance per pole (average value)		mΩ	0.45
<hr/>			
Power dissipation per pole (average value)	Ith	W	11.5
	AC-3	W	6.0
<hr/>			
Tightening torque for terminals	min	Nm	6
	max	Nm	7
	min	Ibin	4.4
	max	Ibin	5.2

Tightening torque for coil terminal

min	Nm	0.8
max	Nm	1
min	Ibin	0.59
max	Ibin	0.74

Conductor section

AWG/Kcmil

max		2/0
-----	--	-----

Flexible w/o lug conductor section

min	mm <sup>2</sup>	1.5
max	mm <sup>2</sup>	70

Flexible c/w lug conductor section

min	mm <sup>2</sup>	1.5
max	mm <sup>2</sup>	70

Power terminal protection according to IEC/EN 60529

IP20 front

**Mechanical features**

Operating position

normal allowable	Vertical plan ±30°
------------------	--------------------

Fixing

Screw / DIN rail 35mm

Weight

g 2020

Conductor section

AWG/kcmil conductor section

max		2/0
-----	--	-----

**Operations**

Mechanical life

cycles 15000000

Electrical life

cycles 1200000

**AC coil operating**

Rated AC voltage at 60Hz

V 230

AC operating voltage

of 50/60Hz coil powered at 50Hz drop-out

max	%Us	55
-----	-----	----

of 60Hz coil powered at 60Hz pick-up

min	%Us	80
max	%Us	110

drop-out

min	%Us	20
max	%Us	55

AC average coil consumption at 20°C

of 60Hz coil powered at 60Hz

in-rush	VA	300
holding	VA	20

**Max cycles frequency**

Mechanical operation

cycles/h 1500

**Operating times**

Average time for Us control

in AC

Closing NO

min	ms	16
max	ms	32

Opening NO

min	ms	9
max	ms	24

**UL technical data**

Yielded mechanical performance

for three-phase AC motor

200/208V	HP	40
220/230V	HP	40
460/480V	HP	75
575/600V	HP	100

**General USE**

Contactor

AC current	A	165
------------	---	-----

Short-circuit protection fuse, 600V

High fault

Short circuit current	kA	100
Fuse rating	A	200
Fuse class		J

Standard fault

Short circuit current	kA	10
Fuse rating	A	250
Fuse class		RK5

**Ambient conditions**

Temperature

Operating temperature

min	°C	-50
max	°C	70

Storage temperature

min	°C	-60
max	°C	+80

Max altitude

m	3000
---	------

**Dimensions**

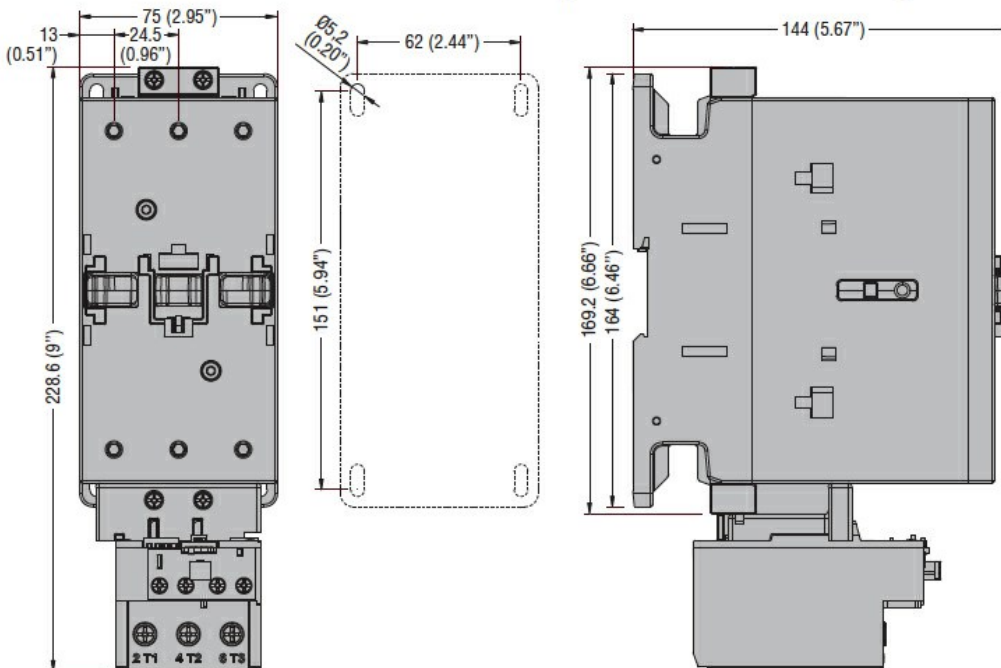

**Wiring diagrams**

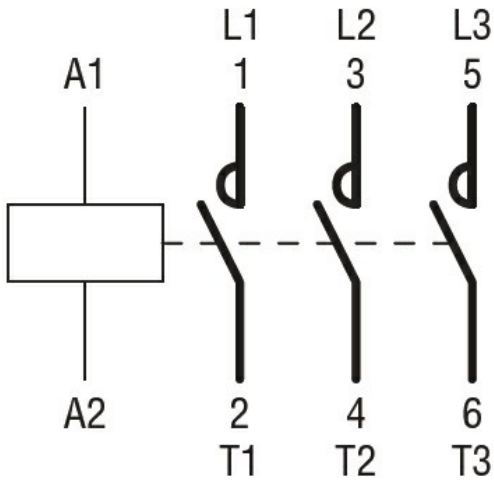

### Certifications and compliance

#### Compliance

CSA C22.2 n° 60947-1

CSA C22.2 n° 60947-4-1

IEC/EN/BS 60947-1

IEC/EN/BS 60947-4-1

UL 60947-1

UL 60947-4-1

#### Certificates

CCC

cULus

### ETIM classification

ETIM 8.0

EC000066 -  
 Power contactor,  
 AC switching