

THIS COPY IS PROVIDED ON A RESTRICTED BASIS AND IS NOT TO BE USED IN ANY WAY DETRIMENTAL TO THE INTERESTS OF PANDUIT CORP.

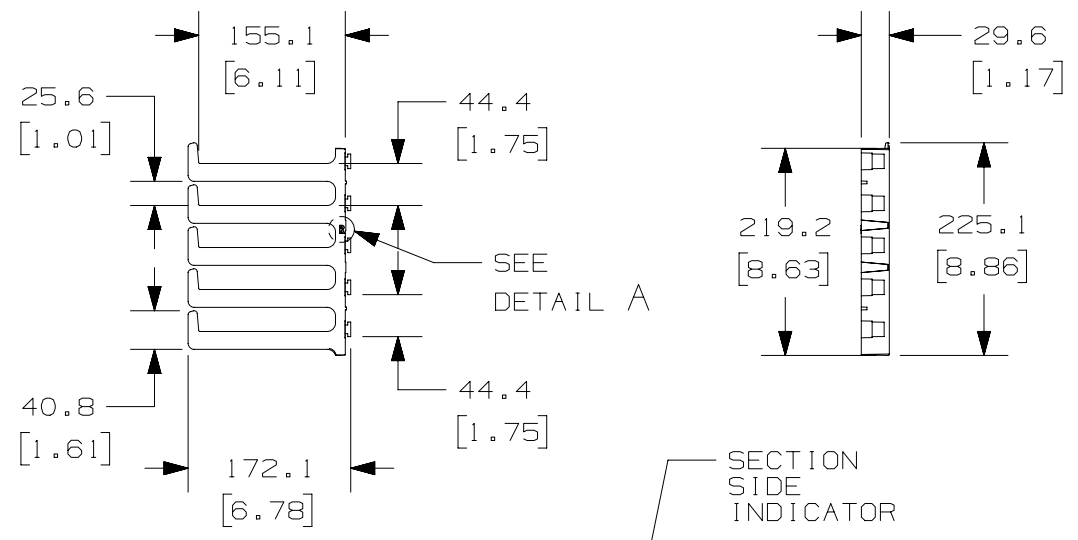

SEE
DETAIL A

SECTION
SIDE
INDICATOR

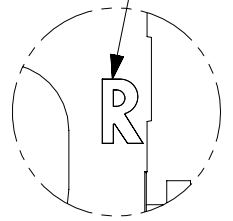

DETAIL A
SCALE 1:1

5RU CABINET FINGER
SECTION-RIGHT HAND

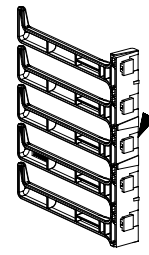
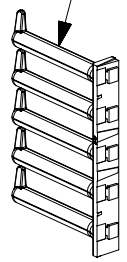

5RU CABINET FINGER
SECTION-LEFT HAND

PANDUIT P/N	WEIGHT
SN28F	3.03 Kg/EACH 6.68 LBS/EACH

- NOTES:
- VISIT OUR ON-LINE CATALOG AT WWW.PANDUIT.COM FOR A LIST OF CURRENT PARTS APPLICABLE FOR USE WITH THIS PRODUCT.
 - DIMENSIONS IN PARENTHESES ARE ENGLISH (in).
 - PARTS SUPPLIED:
 - (3)- 5RU RIGHT HAND LONG FINGER SECTIONS
 - (3)- 5RU LEFT HAND LONG FINGER SECTIONS
 - (4)- 8RU RIGHT HAND LONG FINGER SECTIONS
 - (4)- 8RU LEFT HAND LONG FINGER SECTIONS

00A	8-14-16	LEE	RELEASED TO PRODUCTION	V09000UH/02		
REV	DATE	BY	CHK	APR	DESCRIPTION	ECN

TITLE		SN28F FG Cable Management Finger Kit		
CUSTOMER DRAWING				
ITEM REVISION NAME		14V427ZE/00		
DATASET FILE NAME		14V427ZE_DC/00A		
UNLESS OTHERWISE SPECIFIED, DIMENSIONAL TOLERANCES ARE:		MATERIAL: N/A		
DRAWING NUMBER:		14V427ZE-DC		
DRAWN BY	DATE	CHK	SCALE	SIZE
LEE	8-14-16		NONE	A

THIS COPY IS PROVIDED ON A RESTRICTED BASIS AND IS NOT TO BE USED IN ANY WAY DETRIMENTAL TO THE INTERESTS OF PANDUIT CORP.

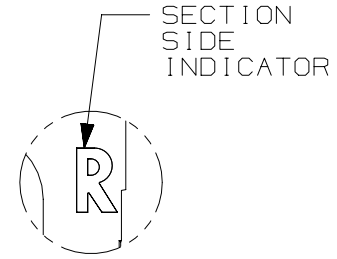
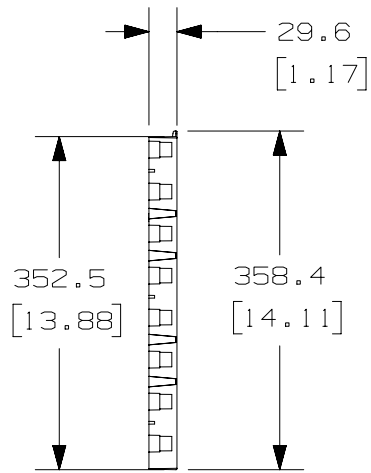
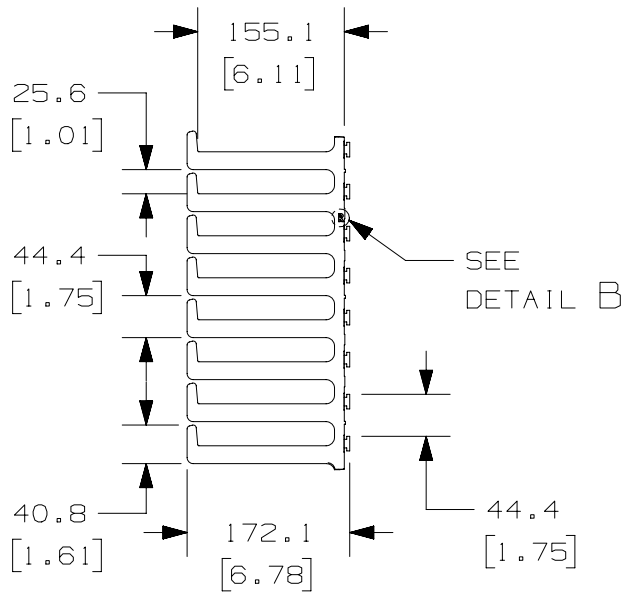

DETAIL B
SCALE 1:1

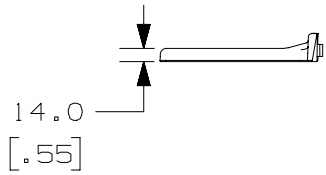

8RU CABINET FINGER SECTION-RIGHT HAND

8RU CABINET FINGER SECTION-LEFT HAND

00A	8-14-16	LEE			SEE SHEET ONE FOR REVISIONS			V09000UH/02	
REV	DATE	BY	CHK	APR	DESCRIPTION			ECN	

TITLE									
SN28F FG Cable Management Finger Kit									
CUSTOMER DRAWING									
ITEM REVISION NAME								14V427ZE/00	
DATASET FILE NAME								14V427ZE_DC/00A	
UNLESS OTHERWISE SPECIFIED, DIMENSIONAL TOLERANCES ARE:								MATERIAL:	
								N/A	
								DRAWING NUMBER:	
								14V427ZE-DC	
DRAWN BY		DATE		CHK		SCALE		SIZE	
LEE		8-14-16				NONE		SHT 2 OF 2	

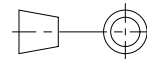

THIRD ANGLE PROJECTION