

Codes-articles:

8246 091464

EAN:

5703821173131



Source lumineuse

Version:	27°
Type de source lumineuse:	LED
Wattage:	16/27W
System wattage:	27.0W
Luminous flux:	1430/2440lm
Efficacité:	53 lm/W
Tension:	230V
Température des couleurs:	3000K
Rendu des couleurs (CRI):	Ra>80
Facteur MacAdams:	SDCM: 2
Durée de vie:	L90/B10>100,000
Light distribution:	Directe
Optique:	Réflecteur Diffus 27 dg.
Faisceau:	27°

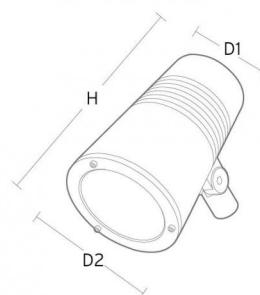

Contrôle/Dimming

Type: Non dimmable

Protection

Classe Isolation:	Classe II
IP:	IP66
Vandal class:	IK07
Ta nominal:	Ta=25°C

Énergie et approbations

Classe énergétique:	A++
Approbation:	CE

Matériaux et finition

Embase:	Aluminium coulé sous pression
Couleur:	Noir (brillance 20%)
Optique:	Verre

Montage/Connexion

Montage:	Pôle, mur, borne ou piquet de terre, Outdoor
Câble:	Cable 2x1mm ² 10m
Wind projected area:	403cm ² - Max 4 kg
Max. luminaires per circuit breaker:	B10: 10, B16: 17, C10: 16, C16: 27

Dimensions (mm)

Hauteur (H):	268
Diameter (D):	180
Poids (brutto/netto):	4.66 / 4.46

Emballage

Dimensions de l'emballage: 240 x 240 x 290

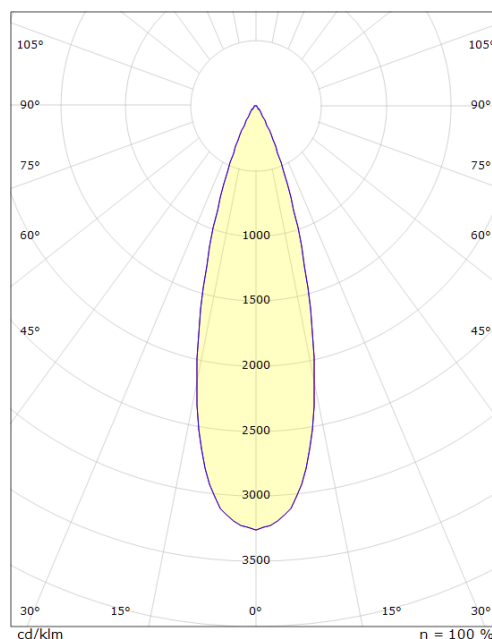
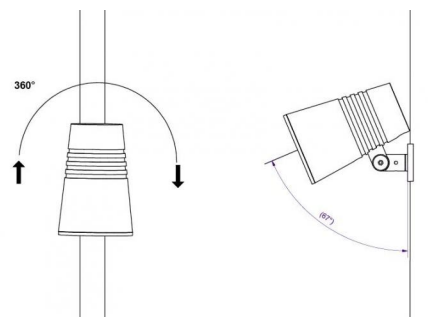

cd/klm
— C0/C180
— C90/C270



5 7 0 3 8 2 1 1 7 3 1 3 1