



Enclosed
changeover
switch
GLZM

Product designation

Product type designation

Number of poles

Operating voltage type

Nr. 4
AC

Contact characteristics

IEC Conventional free air thermal current I_{th} A 315

Rated insulation voltage U_i IEC/EN V 1000

Rated impulse withstand voltage U_{imp} kV 12

Operating current I_e

AC21A

400V A 315
500V A 315
690V A 315

AC22A

400V A 315
500V A 315
690V A 315

AC23A

400V A 315
500V A 250
690V A 250

Power dissipation per pole max W 6.5

Rated operational power AC23A

400V kW 140
690V kW 250

Conditional short-circuit current (rms) kA 100

Short-circuit protection with fuse Class/A gG/315

Making capacity AC23A 400V A 2500

Breaking capacity AC23A 400V A 2000

Mechanical life cycles 10000

Electrical life AC21A cycles 0

Mechanical features

Operating position

normal
allowable Vertical plan
Any

Terminals

type height mm M8 x 25
0

Tightening torque for terminals

min Nm 15
max Nm 22
min lbin 132
max lbin 194

Conductor section

IEC min	mm ²	70
IEC max	mm ²	185
AWG/kcmil min		00
AWG/kcmil max		400

Ambient conditions

Operating temperature

min	°C	-25
max	°C	+55

Storage temperature

min	°C	-40
max	°C	+70

Max altitude

m	3000
---	------

Resistance & Protection

Frontal IP degree IP65

IP degree of protection IP65

Pollution degree 3

Dimensions

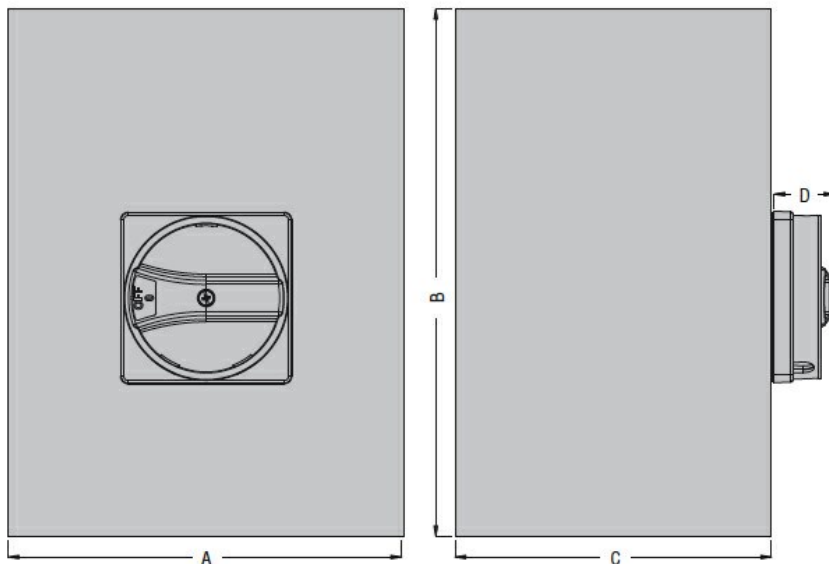

Type	A	B	C	D
GLZM0160 E...GLZM0315 E...	300 (11.81")	400 (15.75")	250 (9.84")	45,7 (1.80")

Wiring diagrams

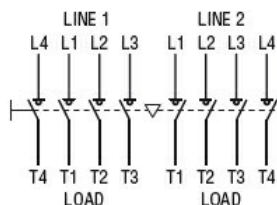

Certifications and compliance

Compliance

IEC/EN 60947-1
IEC/EN 60947-6-1

ETIM classification

ETIM 8.0

EC000216 -
Switch
disconnecter

