



# WL9GC-3P2432A71

W9

SMALL PHOTOELECTRIC SENSORS

**SICK**  
Sensor Intelligence.



Illustration may differ



## Ordering information

Type	Part no.
WL9GC-3P2432A71	1080920

The sensor is equipped with a special Smart Task function. Additional information can be found in the "Technical Data." Use of the sensor for pure object detection is limited.

Other models and accessories → [www.sick.com/W9](http://www.sick.com/W9)

## Detailed technical data

### Features

<b>Functional principle</b>	Photoelectric retro-reflective sensor
<b>Functional principle detail</b>	Autocollimation
<b>Dimensions (W x H x D)</b>	12.2 mm x 52.2 mm x 23.6 mm
<b>Housing design (light emission)</b>	Rectangular
<b>Mounting hole</b>	M3
<b>Sensing range max.</b>	0 m ... 5 m <sup>1)</sup>
<b>Sensing range</b>	0 m ... 3 m <sup>1)</sup>
<b>Type of light</b>	Visible red light
<b>Light source</b>	PinPoint LED <sup>2)</sup>
<b>Light spot size (distance)</b>	Ø 45 mm (1.5 m)
<b>Wave length</b>	650 nm
<b>Adjustment</b>	IO-Link Single teach-in button
<b>Pin 2 configuration</b>	External input, Teach-in input, Sender off input, Detection output, logic output, Device contamination alarm output
<b>AutoAdapt</b>	✓
<b>Special feature</b>	Detecting transparent objects
<b>Special applications</b>	Detecting transparent objects

<sup>1)</sup> Reflector PL80A.

<sup>2)</sup> Average service life: 100,000 h at T<sub>U</sub> = +25 °C.

## Mechanics/electronics

<b>Supply voltage <math>U_B</math></b>	10 V DC ... 30 V DC <sup>1)</sup>
<b>Ripple</b>	< 5 V <sub>pp</sub> <sup>2)</sup>
<b>Current consumption</b>	20 mA <sup>3)</sup>
<b>Switching output</b>	PNP <sup>4) 5)</sup>
<b>Output function</b>	Complementary
<b>Switching mode</b>	Light/dark switching <sup>4)</sup>
<b>Output current <math>I_{max.}</math></b>	≤ 100 mA <sup>6)</sup>
<b>Response time</b>	< 0.5 ms <sup>7)</sup>
<b>Response time Q/ on Pin 2</b>	300 μs ... 450 μs <sup>7) 8)</sup>
<b>Switching frequency</b>	1,000 Hz <sup>9)</sup>
<b>Switching frequency Q / to pin 2</b>	≤ 1,000 Hz <sup>10)</sup>
<b>Connection type</b>	Male connector M12, 4-pin
<b>Circuit protection</b>	A <sup>11)</sup> B <sup>12)</sup> C <sup>13)</sup>
<b>Protection class</b>	III
<b>Weight</b>	13 g
<b>Polarisation filter</b>	✓
<b>Housing material</b>	Plastic, VISTAL®
<b>Optics material</b>	Plastic, PMMA
<b>Enclosure rating</b>	IP66 IP67 IP69K
<b>Special feature</b>	Detecting transparent objects
<b>Ambient operating temperature</b>	-40 °C ... +60 °C
<b>Ambient temperature, storage</b>	-40 °C ... +75 °C
<b>UL File No.</b>	NRKH.E181493
<b>Repeatability Q/ on Pin 2:</b>	150 μs <sup>8)</sup>

<sup>1)</sup> Limit values when operated in short-circuit protected network: max. 8 A.

<sup>2)</sup> May not exceed or fall below  $U_V$  tolerances.

<sup>3)</sup> Without load.

<sup>4)</sup> Q = light switching.

<sup>5)</sup> Pin 4: this switching output must not be connected to any other output.

<sup>6)</sup> At and above  $T_u$  50 °C, a max. load current of  $I_{max.} = 50$  mA is permitted.

<sup>7)</sup> Signal transit time with resistive load.

<sup>8)</sup> Valid for Q \ on Pin2, if configured with software.

<sup>9)</sup> With light/dark ratio 1:1.

<sup>10)</sup> With light / dark ratio 1:1, valid for Q \ on Pin2, if configured with software.

<sup>11)</sup> A =  $V_S$  connections reverse-polarity protected.

<sup>12)</sup> B = inputs and output reverse-polarity protected.

<sup>13)</sup> C = interference suppression.

## Safety-related parameters

<b>MTTF<sub>D</sub></b>	1,222 years
-------------------------	-------------

<b>DC<sub>avg</sub></b>	0 %
-------------------------	-----

### Communication interface

<b>Communication interface</b>	IO-Link V1.1
<b>Communication Interface detail</b>	COM2 (38,4 kBaud)
<b>Cycle time</b>	2.3 ms
<b>Process data length</b>	16 Bit
<b>Process data structure</b>	Bit 0 = switching signal Q <sub>L1</sub> Bit 1 = switching signal Q <sub>L2</sub> Bit 2 ... 15 = measuring value
<b>VendorID</b>	26
<b>DeviceID HEX</b>	0x8000E1
<b>DeviceID DEC</b>	8388833

### Smart Task

<b>Smart Task name</b>	Counter + debouncing
<b>Logic function</b>	Direct WINDOW Hysteresis
<b>Timer function</b>	Deactivated On delay Off delay ON and OFF delay Impulse (one shot)
<b>Inverter</b>	Yes
<b>Maximum counting frequency</b>	SIO Direct: --- <sup>1)</sup> SIO Logic: 1000 Hz <sup>2)</sup> IOL: 900 Hz <sup>3)</sup>
<b>Counter reset</b>	SIO Direct: --- SIO Logic: 1,5 ms IOL: 1,5 ms
<b>Min. Time between two process events (switches)</b>	SIO Direct: --- SIO Logic: 450 µs IOL: 500 µs
<b>Debounce time max.</b>	SIO Direct: --- SIO Logic: 30.000 ms IOL: 30.000 ms
<b>Switching signal</b>	
Switching signal Q <sub>L1</sub>	Output type (dependant on the adjusted threshold)
Switching signal Q <sub>L2</sub>	Output type (dependant on the adjusted threshold)
<b>Measuring value</b>	Counting value

<sup>1)</sup> SIO Direct: sensor operation in standard I/O mode without IO-Link communication and without using internal sensor logic or time parameters (set to "direct"/"deactivated").

<sup>2)</sup> SIO Logic: Sensor operation in standard I/O mode without IO-Link communication. Sensor-internal logic or timing parameters plus Automation Functions used.

<sup>3)</sup> IOL: Sensor operation with full IO-Link communication and usage of logic, timing and Automation Function parameters.

### Diagnosis

<b>Device status</b>	Yes
<b>Quality of teach</b>	Yes
<b>Quality of run</b>	Yes, Contamination display

## Classifications

<b>ECLASS 5.0</b>	27270902
<b>ECLASS 5.1.4</b>	27270902
<b>ECLASS 6.0</b>	27270902
<b>ECLASS 6.2</b>	27270902
<b>ECLASS 7.0</b>	27270902
<b>ECLASS 8.0</b>	27270902
<b>ECLASS 8.1</b>	27270902
<b>ECLASS 9.0</b>	27270902
<b>ECLASS 10.0</b>	27270902
<b>ECLASS 11.0</b>	27270902
<b>ECLASS 12.0</b>	27270902
<b>ETIM 5.0</b>	EC002717
<b>ETIM 6.0</b>	EC002717
<b>ETIM 7.0</b>	EC002717
<b>ETIM 8.0</b>	EC002717
<b>UNSPSC 16.0901</b>	39121528

## Adjustments

Single teach-in button

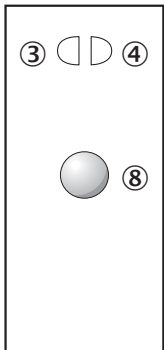

- ③ LED indicator yellow: Status of received light beam
- ④ LED indicator green: power on
- ⑧ Teach-in button

## Connection type

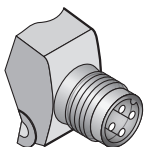

Connection diagram

Cd-367

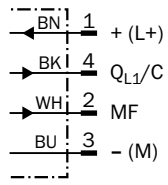

Characteristic curve

WL9G-3

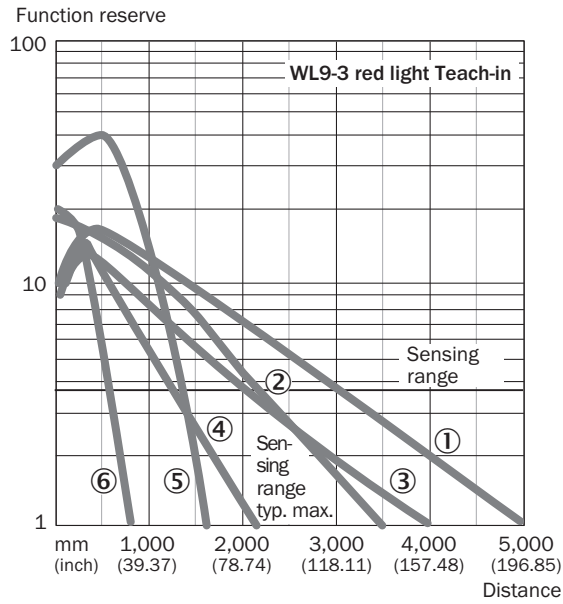

- ① Reflector PL80A
- ② Reflector P250F
- ③ Reflector PL40A
- ④ Reflector PL20F
- ⑤ PL10F reflector
- ⑥ Reflective tape REF-IRF-56

Light spot size

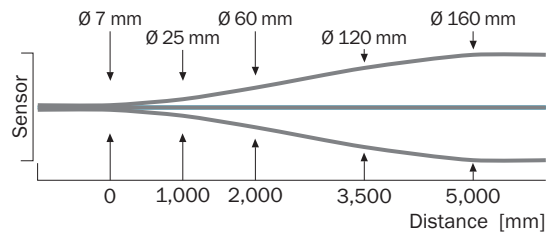

## Sensing range diagram

WL9G-3

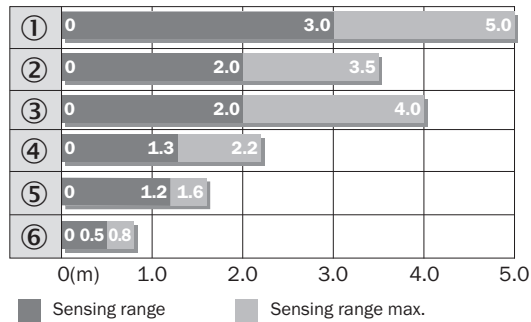

- ① Reflector PL80A
- ② Reflector P250F
- ③ Reflector PL40A
- ④ Reflector PL20F
- ⑤ PL10F reflector
- ⑥ Reflective tape REF-IRF-56

## Dimensional drawing (Dimensions in mm (inch))



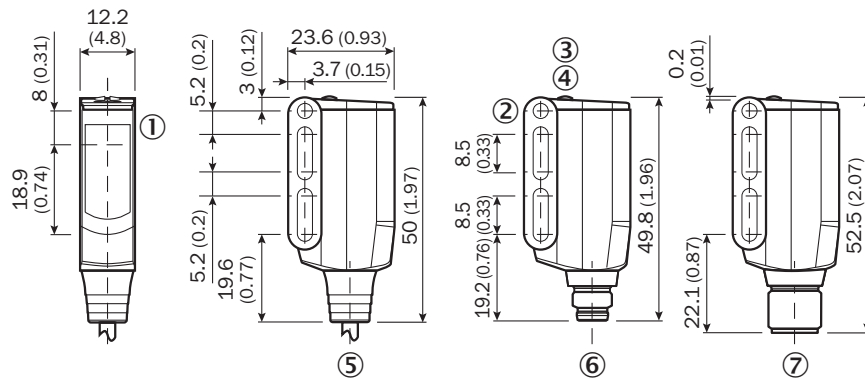

WL9-3, WSE9-3



- ① Sender and receiver optical axis center
- ② Mounting hole M3 (Ø 3.1 mm)
- ③ LED indicator yellow: Status of received light beam
- ④ LED indicator green: power on
- ⑤ Connecting cable or connector
- ⑥ Male connector M8, 4-pin
- ⑦ Male connector M12, 4-pin

### Recommended accessories

Other models and accessories → [www.sick.com/W9](http://www.sick.com/W9)

	Brief description	Type	Part no.
<b>Mounting brackets and plates</b>			
	Mounting bracket, steel, zinc coated, mounting hardware included	BEF-WN-W9-2	2022855
<b>Plug connectors and cables</b>			
	Head A: female connector, M12, 4-pin, straight, A-coded Head B: Flying leads Cable: Sensor/actuator cable, PVC, unshielded, 5 m	YF2A14-050VB3XLEAX	2096235
	Head A: male connector, M12, 4-pin, straight Cable: unshielded	STE-1204-G	6009932
<b>Reflectors</b>			
	Fine triple reflector, screw connection, suitable for laser sensors, 52 mm x 62 mm, PM-MA/ABS, Screw-on, 2 hole mounting	P250F	5308843

### Recommended services

Additional services → [www.sick.com/W9](http://www.sick.com/W9)

	Type	Part no.
<b>Function Block Factory</b>		
<ul style="list-style-type: none"> <li><b>Description:</b> The Function Block Factory supports common programmable logic controllers (PLCs) from various manufacturers, such as Siemens, Beckhoff, Rockwell Automation and B&amp;R. More information on the FBF can be found <a href="https://fbf.cloud.sick.com">here</a>.</li> <li><b>Note:</b> You can configure your function block at <a href="https://fbf.cloud.sick.com">Function Block Factory</a>. As a login please use your SICK ID.</li> </ul>	Function Block Factory	On request



## SICK AT A GLANCE

SICK is one of the leading manufacturers of intelligent sensors and sensor solutions for industrial applications. A unique range of products and services creates the perfect basis for controlling processes securely and efficiently, protecting individuals from accidents and preventing damage to the environment.

We have extensive experience in a wide range of industries and understand their processes and requirements. With intelligent sensors, we can deliver exactly what our customers need. In application centers in Europe, Asia and North America, system solutions are tested and optimized in accordance with customer specifications. All this makes us a reliable supplier and development partner.

Comprehensive services complete our offering: SICK LifeTime Services provide support throughout the machine life cycle and ensure safety and productivity.

For us, that is “Sensor Intelligence.”

## WORLDWIDE PRESENCE:

Contacts and other locations –[www.sick.com](http://www.sick.com)