

THIS COPY IS PROVIDED ON A RESTRICTED BASIS AND IS NOT TO BE USED IN ANY WAY DETRIMENTAL TO THE INTERESTS OF PANDUIT CORP.

NOTES:

- VISIT OUR ON-LINE CATALOG AT WWW.PANDUIT.COM FOR A LIST OF CURRENT PARTS APPLICABLE FOR USE WITH THIS PRODUCT.
- PRIMARY DIMENSIONS ARE IN MILLIMETERS.
- PARTS SUPPLIED:
 - (2) 5RU RIGHT HAND LONG FINGER
 - (2) 5RU LEFT HAND LONG FINGER
 - (5) 8RU RIGHT HAND LONG FINGER
 - (5) 8RU LEFT HAND LONG FINGER
 - (1) INSTALLATION INSTRUCTION (NOT SHOWN)

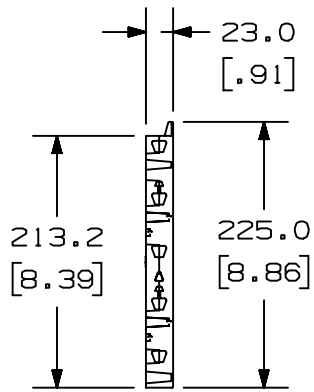
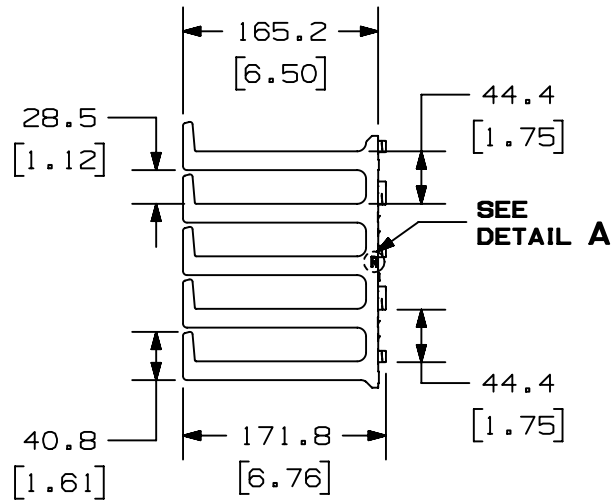
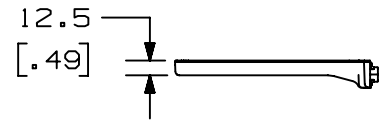

PANDUIT PART NO.	WEIGHT
XG-FML51*	2.2 Kg/EACH 4.97 LBS/EACH

* DENOTES COLOR
ADD SUFFIX "B" FOR BLACK
AND "W" FOR WHITE.

5RU RIGHT HAND
LONG FINGER



5RU LEFT HAND
LONG FINGER

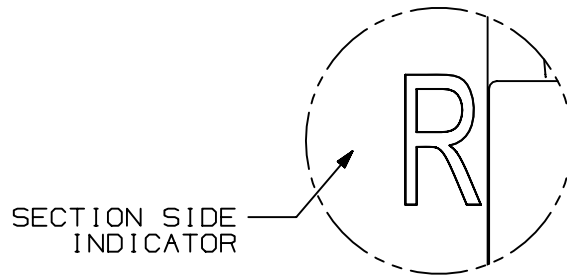
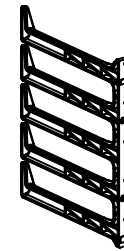

DETAIL A
SCALE 2:1

TITLE		FLEXFUSION 51RU LONG FINGER KIT (XG-FML51B & XG-FML51W)		CUSTOMER DRAWING	
ITEM REVISION NAME		00462EAJ/01		PANDUIT	
DATASET FILE NAME		00462EAJ_DC/01A			
DRAWING NUMBER:		00462EAJ_DC		MATERIAL:	
				N/A	
DRAWN BY		DATE		THIRD ANGLE PROJECTION	
MEX-JAGC		2/22/21			
REV		DESCRIPTION		ECN	
01A		DRAWING RELEASE		V09002ER/07	
BY		CHK		SCALE	
MEX-JAGC		EWSA		NONE	
DATE		APR		SHT 1 OF 2	
2/22/21				A	

ANGLOBAL-ASIZE

THIS COPY IS PROVIDED ON A RESTRICTED BASIS AND IS NOT TO BE USED IN ANY WAY DETRIMENTAL TO THE INTERESTS OF PANDUIT CORP.

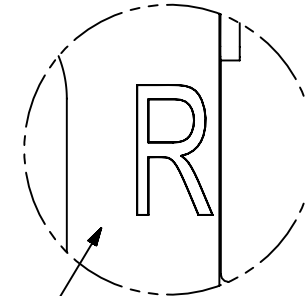
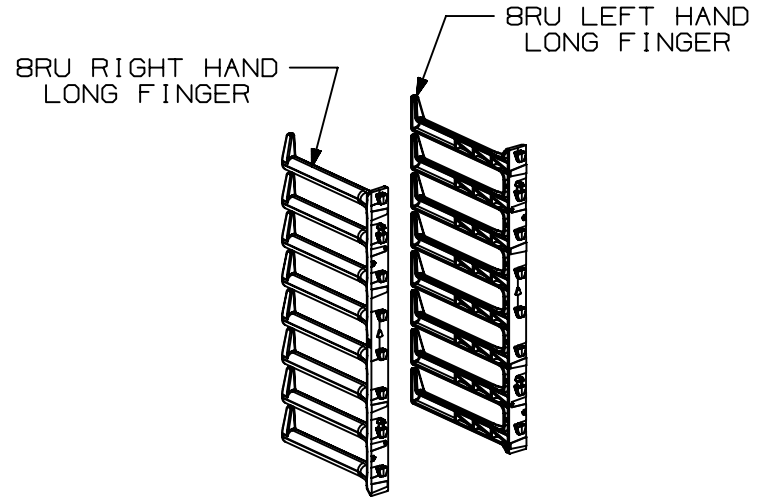
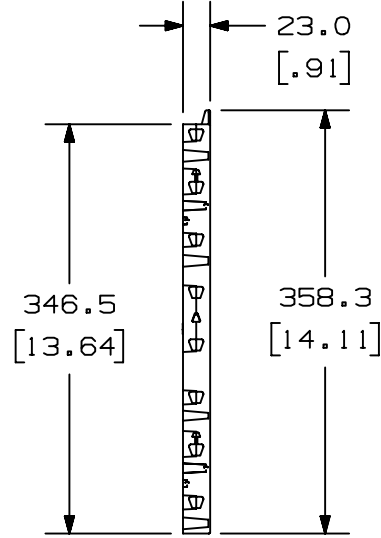
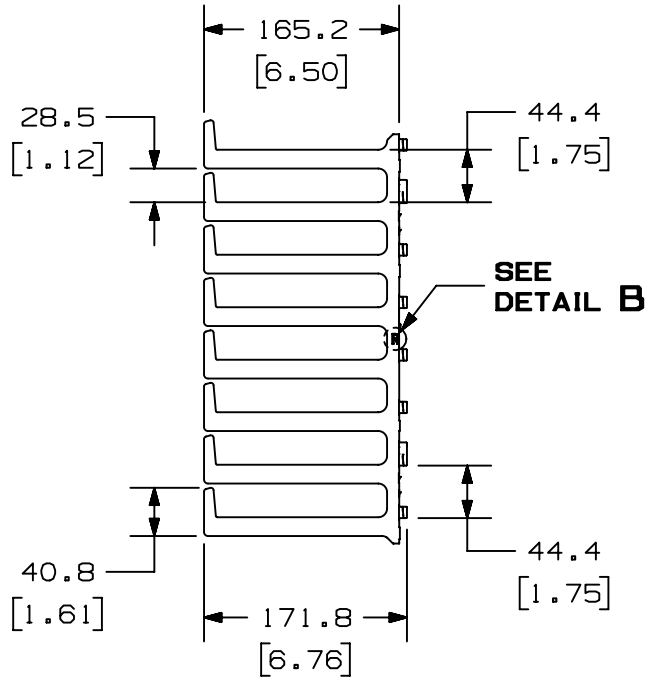
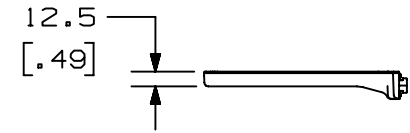

SECTION SIDE INDICATOR

**DETAIL B
SCALE 2:1**

TITLE		FLEXFUSION 51RU LONG FINGER KIT (XG-FML51B & XG-FML51W)		
ITEM REVISION NAME		CUSTOMER DRAWING		
00462EAJ/01		PANDUIT		
DATASET FILE NAME				
MATERIAL		N/A		
DRAWING NUMBER		00462EAJ_DC		
DRAWN BY		DATE		THIRD ANGLE PROJECTION
MEX-JAGC		2/22/21		
CHK		SCALE		SHT 2 OF 2
EWSA		NONE		
REV		SIZE		A
01A		2/22/21		
BY		MEX-JAGC		
CHK		EWSA		
APR		ELE		
DESCRIPTION		DRAWING RELEASE		
ECN		V09002ER/07		

GLOBAL ASIZE