



WS/WE150-P430

W150

MINIATURE PHOTOELECTRIC SENSORS

SICK
Sensor Intelligence.



Illustration may differ



Ordering information

Type	Part no.
WS/WE150-P430	6011032

Included in delivery: BEF-W150-A (1)

Other models and accessories → www.sick.com/W150

Detailed technical data

Features

Functional principle	Through-beam photoelectric sensor
Dimensions (W x H x D)	10 mm x 28 mm x 17.5 mm
Housing design (light emission)	Rectangular
Sensing range max.	0 m ... 4.4 m
Sensing range	0 m ... 4 m
Focus	6°
Type of light	Visible red light
Light source	LED ¹⁾
Angle of dispersion	6°
Adjustment	Potentiometer, 270°

¹⁾ Average service life: 100,000 h at T_J = +25 °C.

Mechanics/electronics

Supply voltage U_B	10 V DC ... 30 V DC ¹⁾
Ripple	± 10 % ²⁾
Current consumption	15 mA ³⁾ 20 mA ⁴⁾
Switching output	PNP

¹⁾ Limit values.

²⁾ May not exceed or fall below U_V tolerances.

³⁾ Sender.

⁴⁾ Receiver.

⁵⁾ Signal transit time with resistive load.

⁶⁾ With light/dark ratio 1:1.

⁷⁾ A = V_S connections reverse-polarity protected.

⁸⁾ B = inputs and output reverse-polarity protected.

⁹⁾ C = interference suppression.

¹⁰⁾ D = outputs overcurrent and short-circuit protected.

Switching mode	Light/dark switching
Switching mode selector	Selectable via L/D control cable
Output current I_{\max}	≤ 100 mA
Response time	≤ 0.5 ms ⁵⁾
Switching frequency	1,000 Hz ⁶⁾
Angle of reception	15°
Connection type	Male connector M8, 4-pin
Circuit protection	A ⁷⁾ B ⁸⁾ C ⁹⁾ D ¹⁰⁾
Protection class	II
Weight	7 g
Enclosure rating	IP67
Items supplied	BEF-W150-A mounting bracket
Ambient operating temperature	-25 °C ... +55 °C
Ambient temperature, storage	-40 °C ... +75 °C
UL File No.	NRNT2.E128350 & NRNT8.E128350

¹⁾ Limit values.

²⁾ May not exceed or fall below U_V tolerances.

³⁾ Sender.

⁴⁾ Receiver.

⁵⁾ Signal transit time with resistive load.

⁶⁾ With light/dark ratio 1:1.

⁷⁾ A = V_S connections reverse-polarity protected.

⁸⁾ B = inputs and output reverse-polarity protected.

⁹⁾ C = interference suppression.

¹⁰⁾ D = outputs overcurrent and short-circuit protected.

Classifications

eCl@ss 5.0	27270901
eCl@ss 5.1.4	27270901
eCl@ss 6.0	27270901
eCl@ss 6.2	27270901
eCl@ss 7.0	27270901
eCl@ss 8.0	27270901
eCl@ss 8.1	27270901
eCl@ss 9.0	27270901
eCl@ss 10.0	27270901
eCl@ss 11.0	27270901
eCl@ss 12.0	27270901
ETIM 5.0	EC002716
ETIM 6.0	EC002716
ETIM 7.0	EC002716
ETIM 8.0	EC002716

UNSPSC 16.0901

39121528

Adjustments

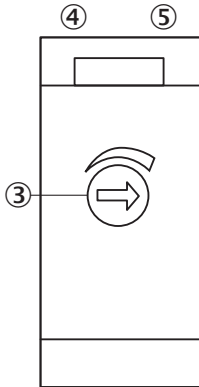

- ③ Sensitivity adjustment 270° (only WE)
- ④ Green LED: stability indicator (WE only)
- ⑤ Orange LED: output active (WE only)

Connection type

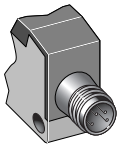

Connection diagram

Cd-060

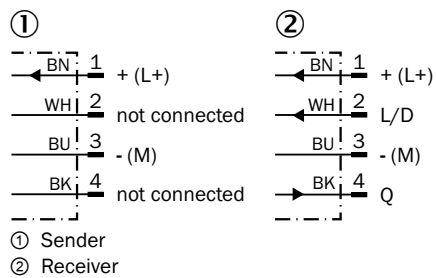

Characteristic curve

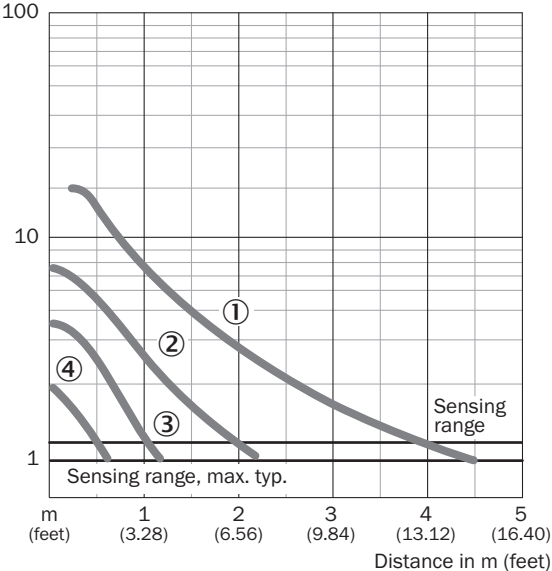

Sensing range diagram

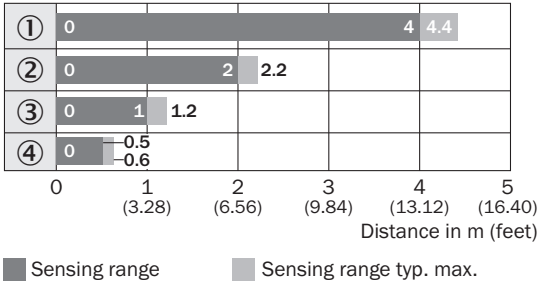

Reduction in sensing range with slotted masks

- ① Without slotted mask
- ② Mask aperture width 2.0 mm
- ③ Mask aperture width 1.0 mm
- ④ Mask aperture width 0.5 mm

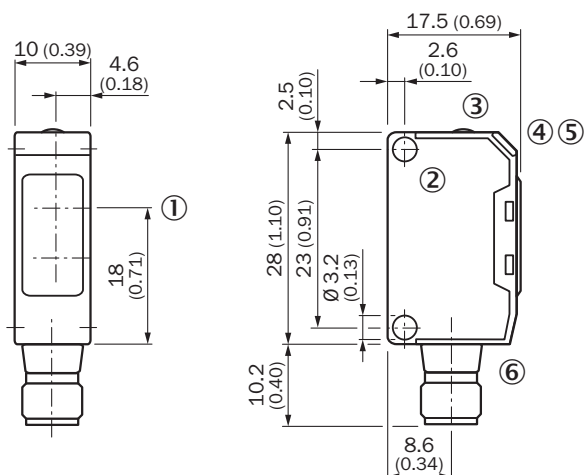

Dimensional drawing (Dimensions in mm (inch))



- ① Center of optical axis
- ② Mounting hole, \varnothing approx. 3.1 mm
- ③ Sensing range adjustment: potentiometer, 5 turns
- ④ LED indicator green: stability indicator
- ⑤ LED indicator orange: output active
- ⑥ Connection

Recommended accessories

Other models and accessories → www.sick.com/W150

	Brief description	Type	Part no.
Plug connectors and cables			
	Head A: female connector, M8, 4-pin, straight, A-coded Head B: Flying leads Cable: Sensor/actuator cable, PVC, unshielded, 5 m	YF8U14-050VA3XLEAX	2095889
	Head A: male connector, M8, 4-pin, straight Cable: unshielded	STE-0804-G	6037323

SICK AT A GLANCE

SICK is one of the leading manufacturers of intelligent sensors and sensor solutions for industrial applications. A unique range of products and services creates the perfect basis for controlling processes securely and efficiently, protecting individuals from accidents and preventing damage to the environment.

We have extensive experience in a wide range of industries and understand their processes and requirements. With intelligent sensors, we can deliver exactly what our customers need. In application centers in Europe, Asia and North America, system solutions are tested and optimized in accordance with customer specifications. All this makes us a reliable supplier and development partner.

Comprehensive services complete our offering: SICK LifeTime Services provide support throughout the machine life cycle and ensure safety and productivity.

For us, that is “Sensor Intelligence.”

WORLDWIDE PRESENCE:

Contacts and other locations –www.sick.com