

Protistor® size 00 aR

1000VAC (IEC)

SEMICONDUCTOR PROTECTION FUSES

SQUARE BODY HIGH-SPEED FUSE-LINKS AC PROTECTION



The 1000V Protistor® fuse-links provide maximum flexibility in equipment design and ultimate protection for small power conversion equipment. These ultra-fast acting aR fuses have been engineered to provide state-of-the-art protection for semiconductors: diodes, thyristors and IGBT devices. They are assembled with die-cut elements embedded in solidified sand, which helps control arcing characteristics for a lower I^2t and high interrupting rating level. All contact surfaces are silver plated and all hardware is non-magnetic. Each fuse-link can be equipped with a low voltage trip-indicator which can operate a field mountable microswitch.

TECHNICAL DATA OVERVIEW

Ampere Range (A)	32 ... 315 A
Size per Standard	00
Speed/Characteristic	aR
I.R. AC (IEC)	100 kA 50 kA
Package	3
Rated voltage AC (IEC)	1000 V

FEATURES & BENEFITS

- Very low I^2t for improved semiconductor protection
- Ultra fast acting
- Superior cycling capability
- Compact Size

APPLICATIONS

- Protection of inverters, motor drives, UPS systems and similar 1000V or less equipments

STANDARDS

- EN 60269-4 compliant



Protistor® size 00 aR

1000VAC (IEC)

PRODUCT RANGE

Size 00 DIN80 1000VAC (IEC)

Catalog number	Item number	Rated voltage AC (IEC)	Rated current I _n	Pre-arcing I ² t	Clearing I ² t at Rated Voltage	Rated breaking capacity AC	Power dissipation at I _n	Weight
DN00UD10C32L	W227581	1000 V	32 A	32 A ² s	230 A ² s	120 kA	17 W	0.22 kg
DN00UD10C40L	G076412	1000 V	40 A	45 A ² s	320 A ² s	120 kA	18.5 W	0.22 kg
DN00UD10C50L	H076413	1000 V	50 A	102 A ² s	704 A ² s	120 kA	19.5 W	0.22 kg
DN00UD10C63L	J076414	1000 V	63 A	181 A ² s	1300 A ² s	120 kA	23 W	0.22 kg
DN00UD10C80L	C075534	1000 V	80 A	347 A ² s	2420 A ² s	120 kA	26.5 W	0.22 kg
DN00UD10C100L	D075535	1000 V	100 A	725 A ² s	4800 A ² s	120 kA	29 W	0.22 kg
DN00UD10C125L	M076417	1000 V	125 A	1400 A ² s	9200 A ² s	120 kA	34 W	0.22 kg
DN00UC10C160L	X076426	1000 V	160 A	2469 A ² s	17300 A ² s	120 kA	39 W	0.25 kg
DN00UC10C200L	Y076427	1000 V	200 A	4527 A ² s	31500 A ² s	120 kA	49 W	0.25 kg
DN00UC10C250L	Z076428	1000 V	250 A	8680 A ² s	60000 A ² s	120 kA	56.5 W	0.25 kg
DN00UC10C280L	A076429	1000 V	280 A	11810 A ² s	81400 A ² s	120 kA	62 W	0.25 kg
DN00UC10C315L	V076263	1000 V	315 A	15430 A ² s	115000 A ² s	50 kA	67 W	0.25 kg

MERSEN reserves the right to change, update or correct, without notice, any information contained in this datasheet.

TIME CURRENT CHARACTERISTIC CURVES

Size 00, 1000VAC, 32 to 150A

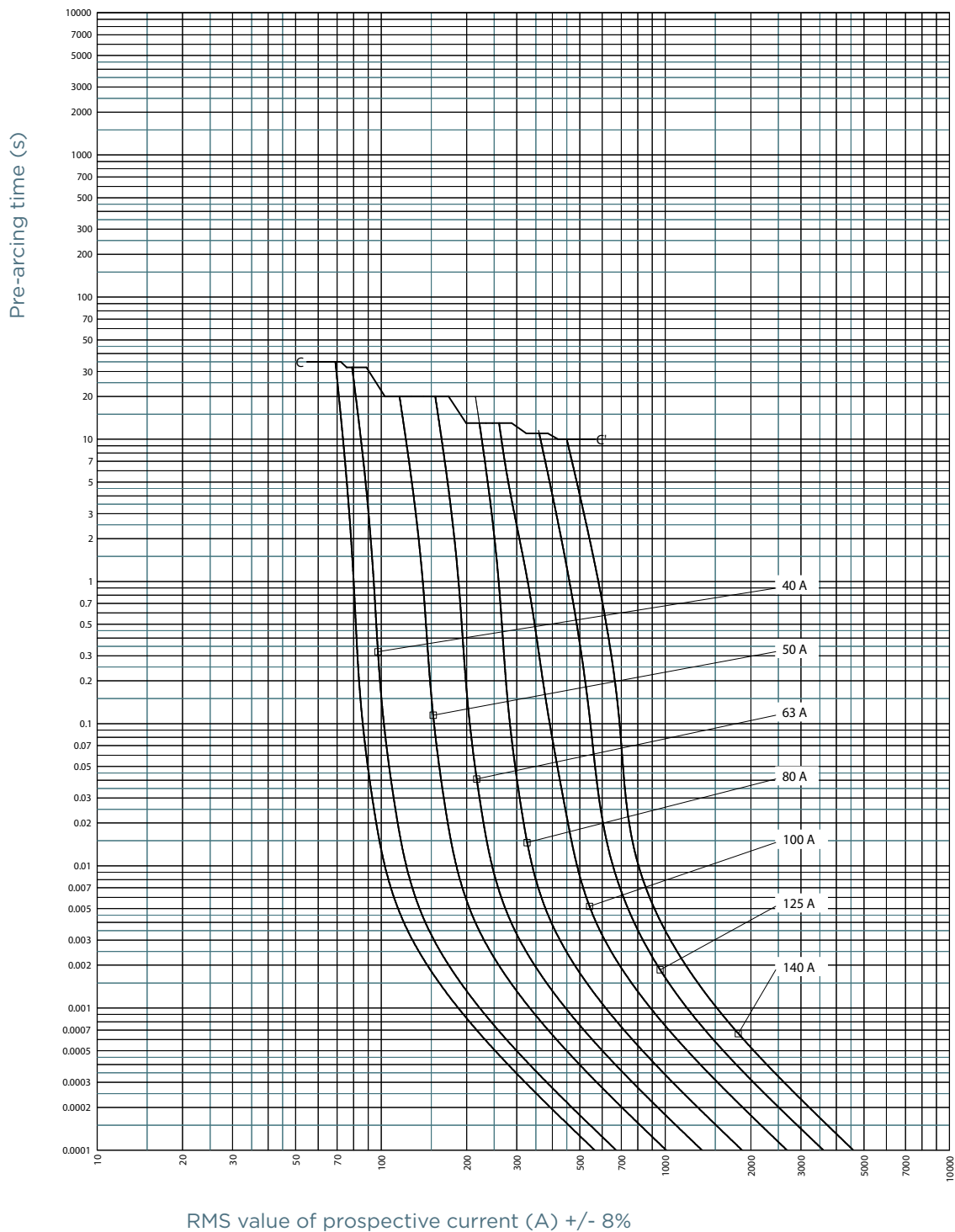

TIME CURRENT CHARACTERISTIC CURVES

Size 00, 1000VAC, 160 to 315A

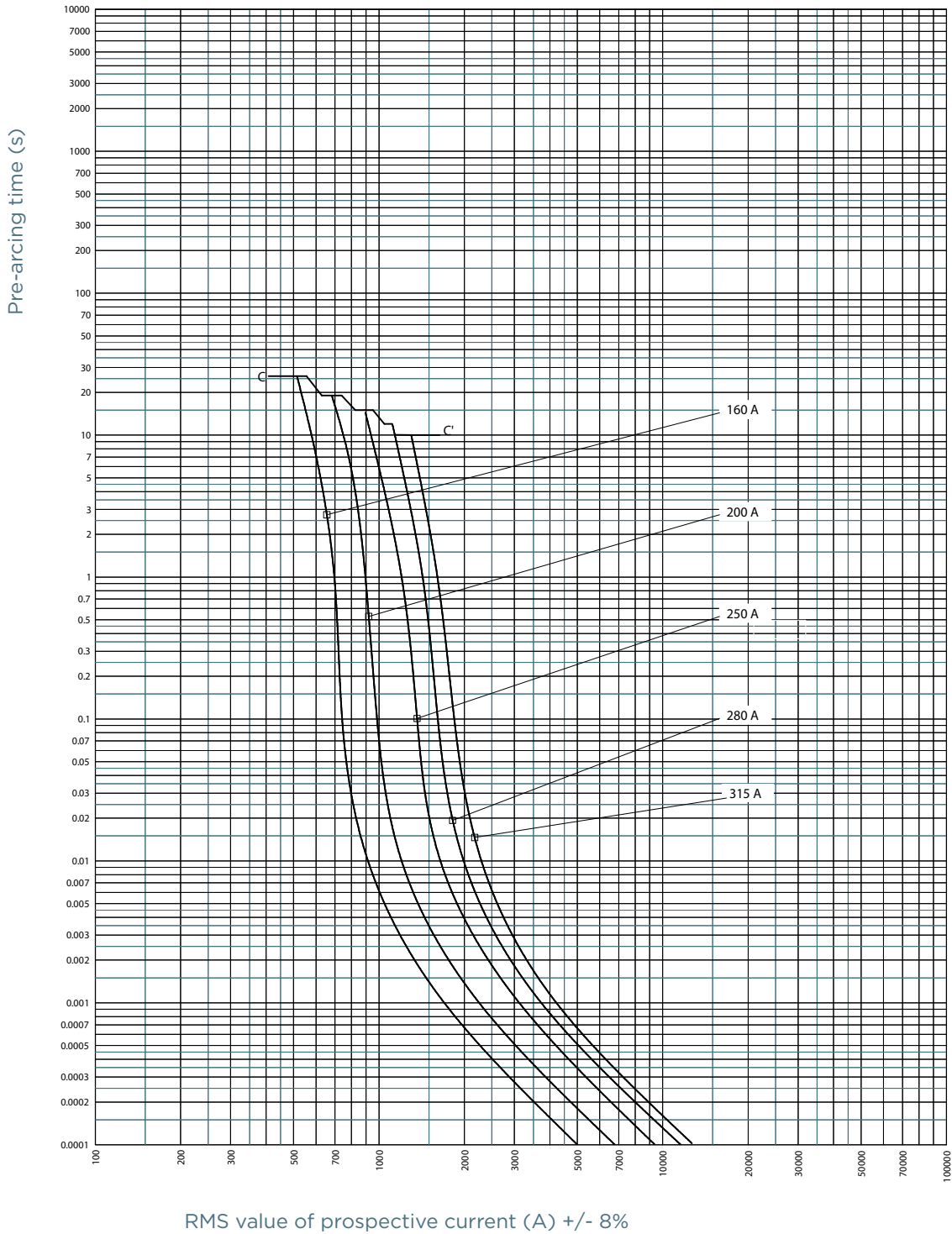

CUT-OFF CURRENT CHARACTERISTIC

Size 00, 1000VAC, 32 to 150A

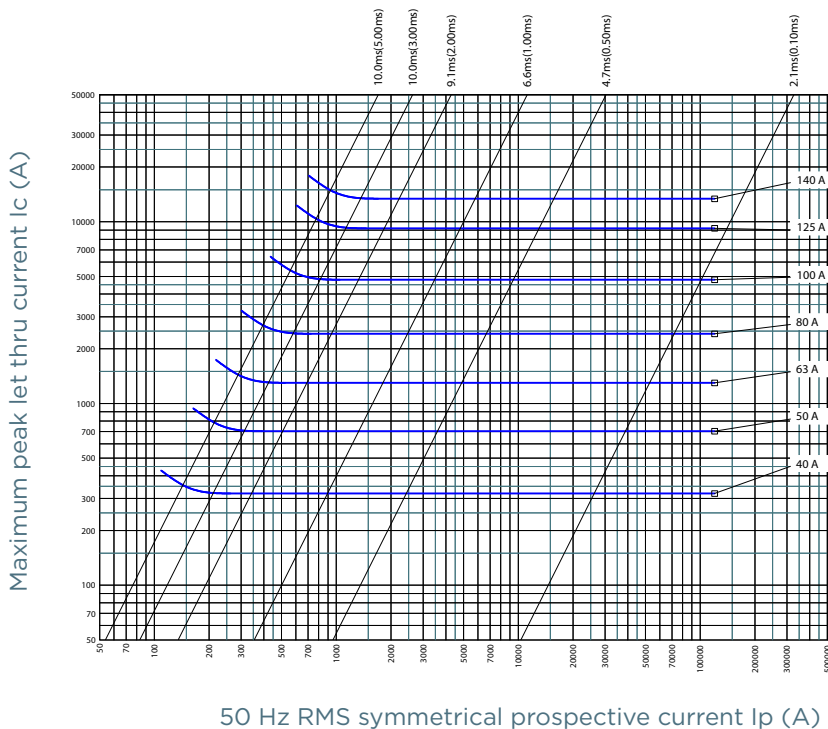

Size 00, 1000VAC, 160 to 315A

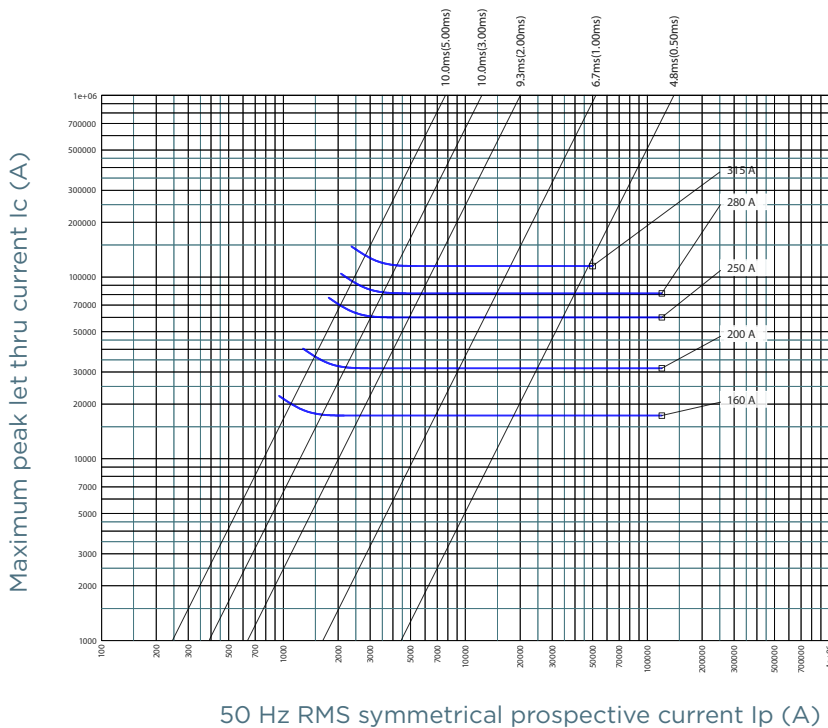

I²T MULTIPLIER COEFFICIENT

Size 00, 1000VAC , 32 to 315A

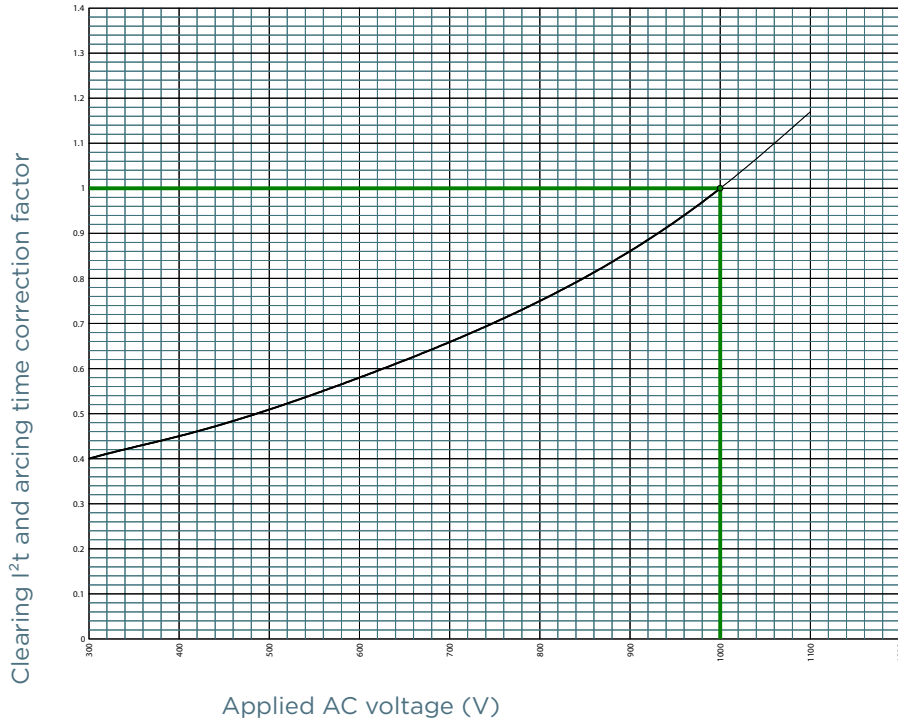

CHARACTERISTICS TOTAL I²T CURVE

Size 00, 1000VAC, 32 to 150A

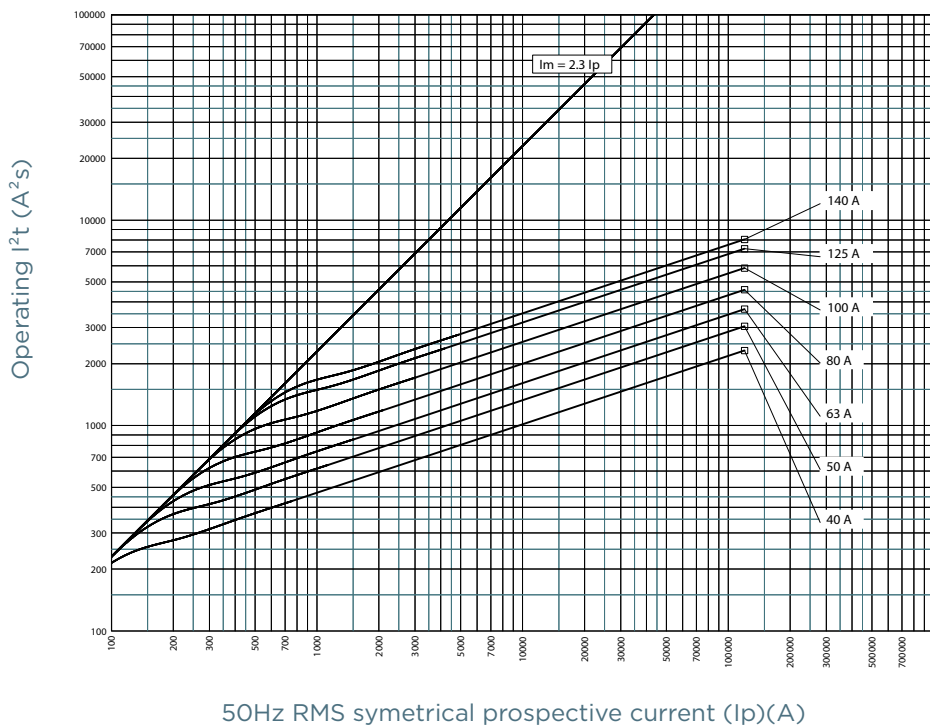

CHARACTERISTICS TOTAL I²T CURVE

Size 00, 1000VAC, 160 to 315A

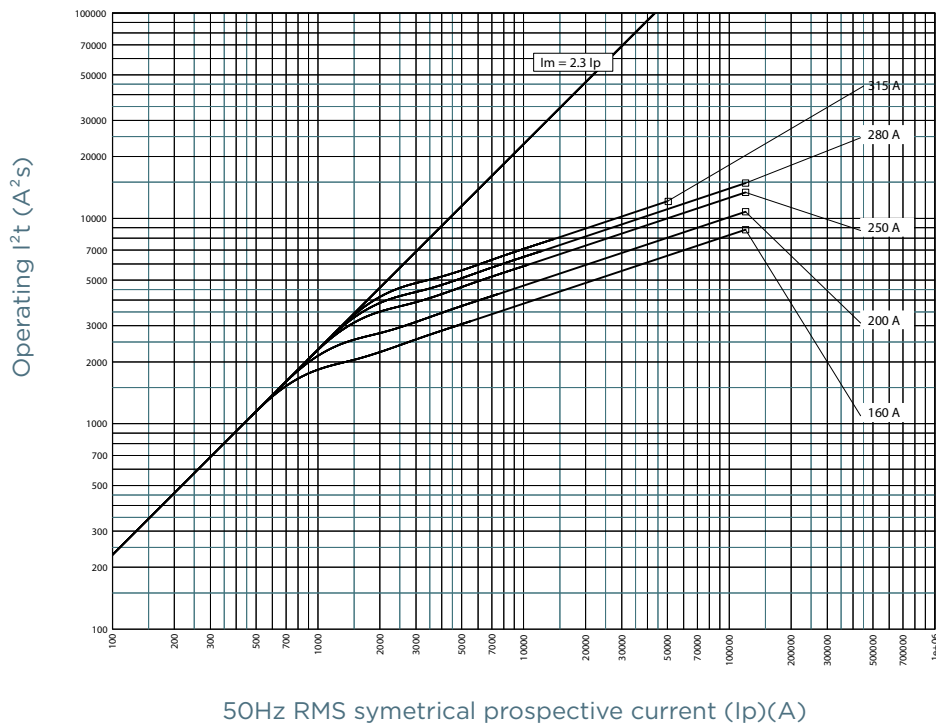

POWER DISSIPATION

Size 00, 1000VAC, 32 to 315A

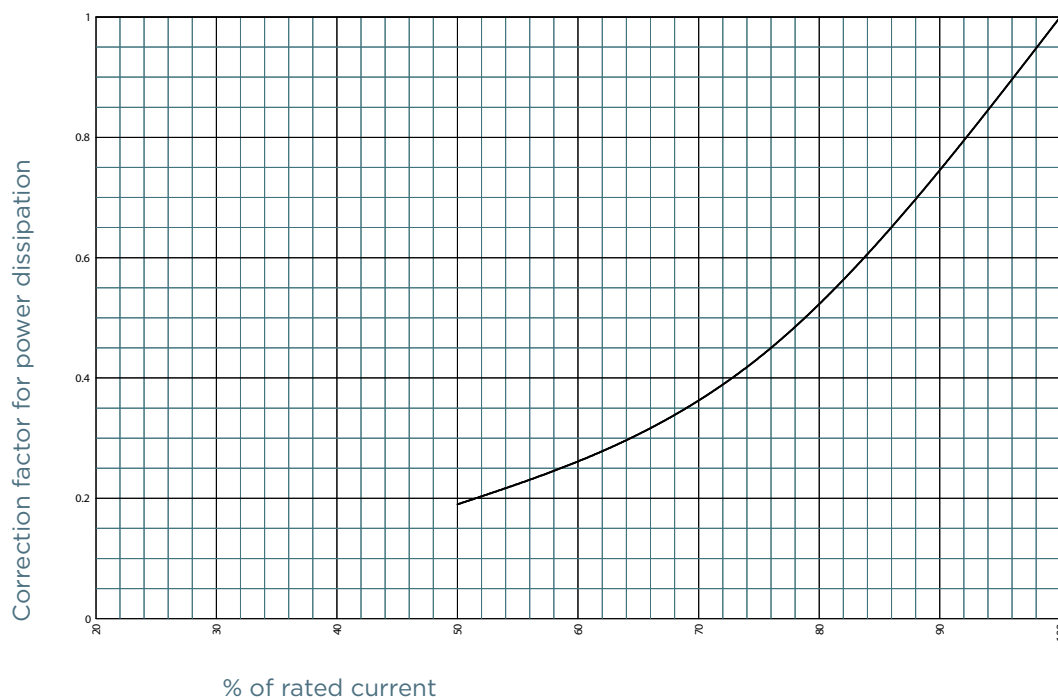

PEAK ARC VOLTAGE

Size 00, 1000VAC, 32 to 315A

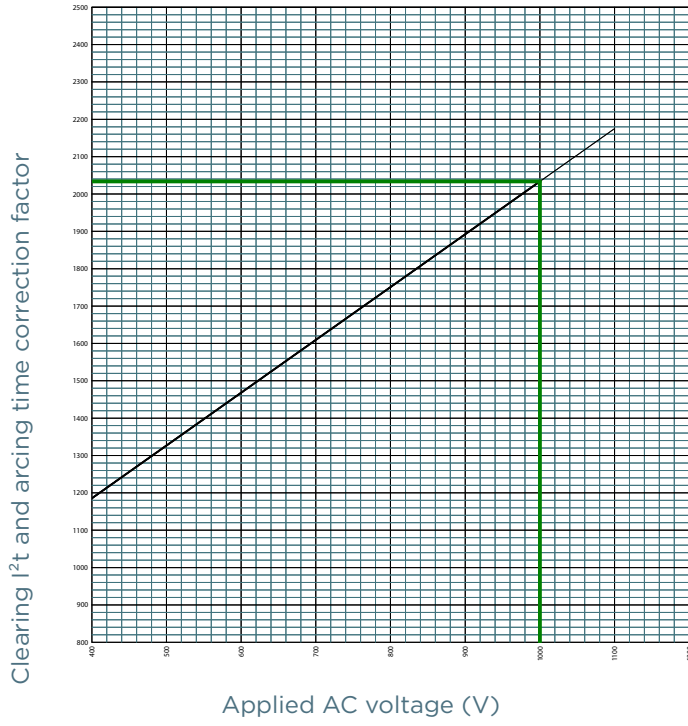

Protistor® size 00 aR

1000VAC (IEC)

DIMENSIONS

Size 00, DIN80, 1000VAC, 32 to 315A

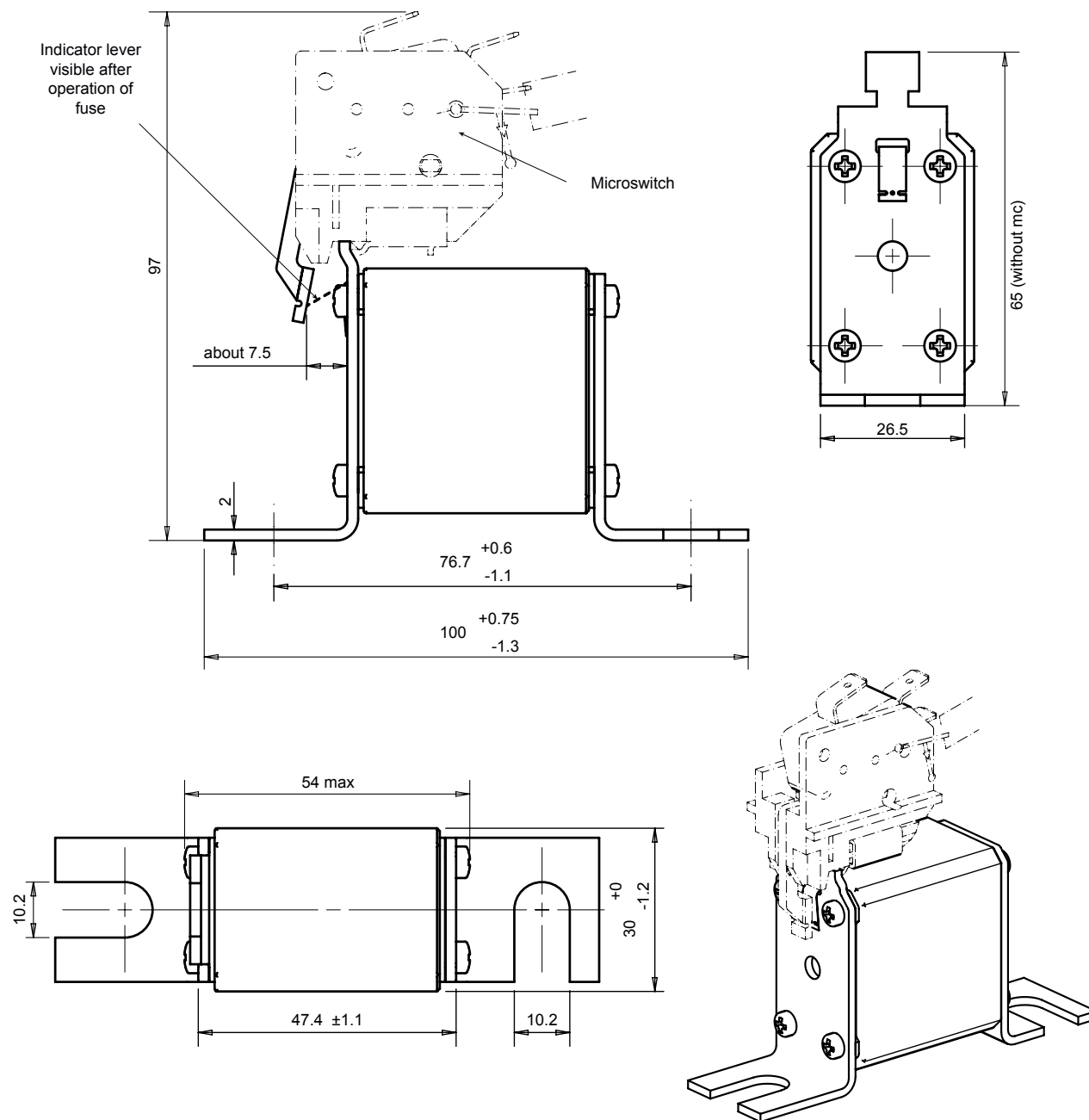

Dimensions in mm