

E

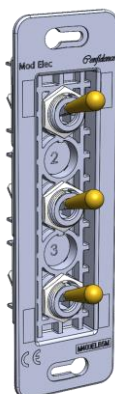

EL

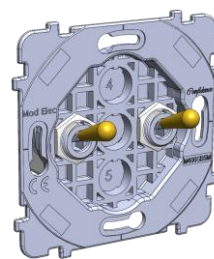

S

1 INSTRUCTIONS ET RECOMMANDATIONS



Avant toute intervention, couper le courant



Dénuder les fils sur 12mm environ
Section câble 0,5 min / 2,5mm² Max



Mécanismes équipés de bornes
à connections à vis



Utiliser des boîtiers de profondeur 50mm
Diamètre 67 ou 68mm pour poste simple

2 CÂBLAGE

 N neutre – câble bleu

 L phase – câble rouge

  terre – câble vert/jaune

Etape 1:

Câblage en croix
A1 – B6
B4 – A3

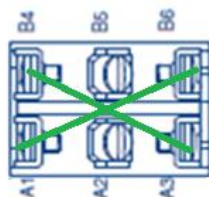

Etape 2:

Câblage des navettes

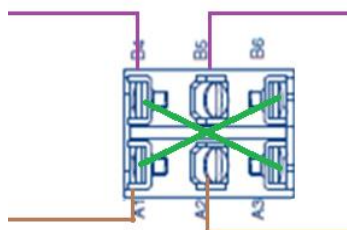

230 volts – 50 Hz

En situation avec 2 va et vient

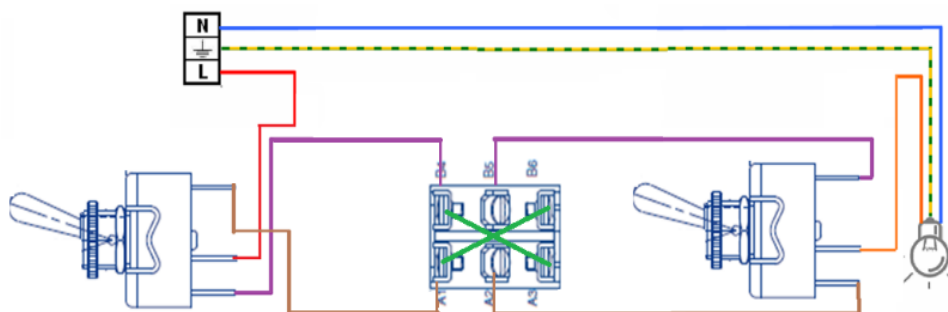

Permutateur
ON / ON

3 MONTAGE

Après avoir réalisé le câblage selon les instructions, placer le mécanisme dans la boîte d'encastement et visser la platine selon les schémas suivants:

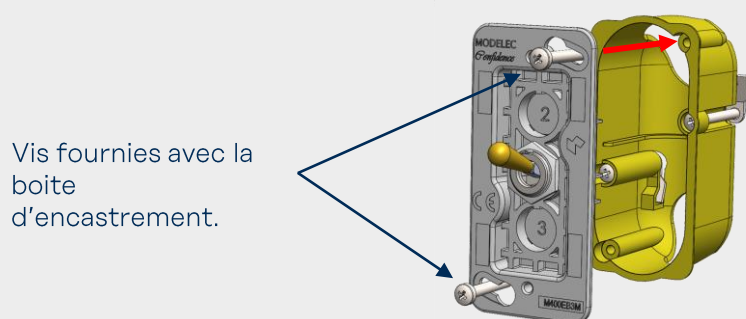
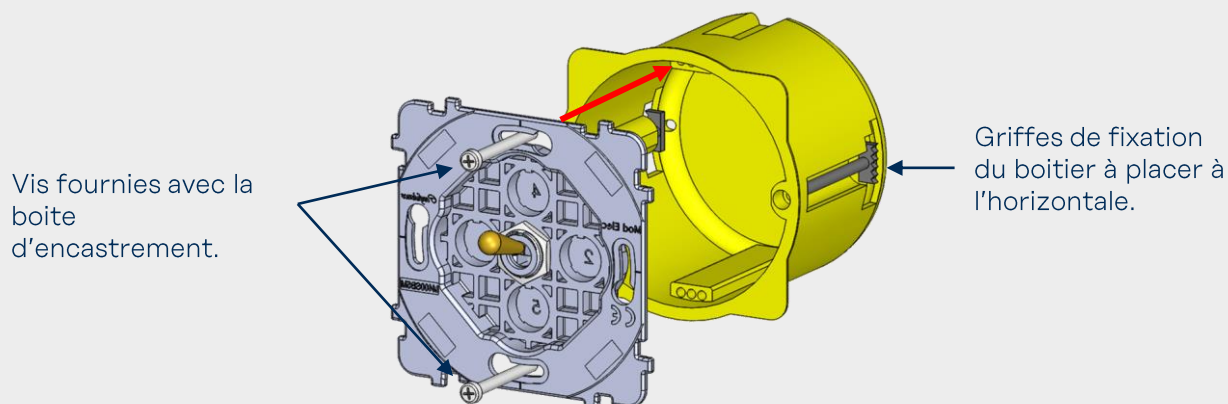

4 TABLE DES RÉFÉRENCES CONCERNÉES

072



073



074



Référence et libellé:

Compatible avec:

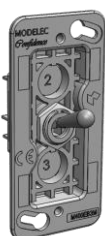

07x-085G E 1 PERMUTATEUR

Collection Confidence

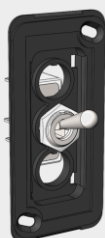

07x-085B E 1 PERMUTATEUR

Collection Karo

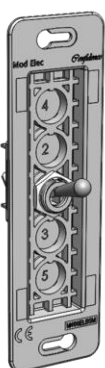

SPM07x-6049G EL 1 PERMUTATEUR

Collection Confidence
Collection Fascination

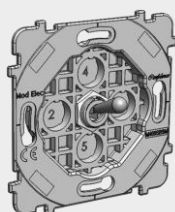

07x-135G S 1 PERMUTATEUR

Collection Confidence
Collection Fascination



5 HOMOLOGATIONS

Les mécanismes va-et-vient 07x sont conformes à la norme NF EN 60-669-01, selon le rapport d'essai n°149741-706752A établi par le LCIE le 13/04/2018.

