



# WFS3-40P01CS01

WFS

**FORK SENSORS**

**SICK**  
Sensor Intelligence.



Illustration may differ



### Ordering information

Type	Part no.
WFS3-40P01CS01	6053761

Other models and accessories → [www.sick.com/WFS](http://www.sick.com/WFS)

### Detailed technical data

#### Features

<b>Functional principle</b>	Fork sensor
<b>Functional principle detail</b>	Optical detection principle
<b>Dimensions (W x H x D)</b>	10 mm x 25 mm x 64.3 mm
<b>Fork width</b>	3 mm
<b>Fork depth</b>	42 mm
<b>Minimum detectable object (MDO)</b>	Gap between Labels / Size of labels: 2 mm <sup>1)</sup>
<b>Label detection</b>	✓
<b>Light source</b>	LED, infrared
<b>Adjustment</b>	Teach-in button, cable (Teach-in, sensitivity, light/dark switching, key lock, Teach-in dynamic)
<b>Teach-in mode</b>	1-point teach-in 2-point teach-in Teach-in dynamic

<sup>1)</sup> Depends on the label thickness.

#### Mechanics/electronics

<b>Current consumption</b>	20 mA <sup>1)</sup>
<b>Switching frequency</b>	15 kHz <sup>2) 3)</sup>
<b>Stability of response time</b>	± 20 µs
<b>Jitter</b>	17 µs
<b>Switching output</b>	PNP
<b>Switching output (voltage)</b>	Push-pull: PNP/NPN High = $U_V - < 2$ V/Low: ≤ 2 V
<b>Switching mode</b>	Light/dark switching

<sup>1)</sup> Without load.

<sup>2)</sup> With light/dark ratio 1:1.

<sup>3)</sup> During teach-in 6 kHz.

<b>Output current <math>I_{max}</math>.</b>	100 mA
<b>Input, teach-in (ET)</b>	Teach: $U > 5\text{ V} \dots < U_V$ Run: $U < 4\text{ V}$
<b>Initialization time</b>	40 ms
<b>Connection type</b>	Cable, 4-wire, 0.5 m
<b>Protection class</b>	III
<b>Circuit protection</b>	$U_V$ connections, reverse polarity protected Output Q short-circuit protected Interference pulse suppression
<b>Enclosure rating</b>	IP65
<b>Weight</b>	Approx. 36 g
<b>Housing material</b>	Plastic, PA (glass-fiber reinforced)

1) Without load.

2) With light/dark ratio 1:1.

3) During teach-in 6 kHz.

### Communication interface

<b>IO-Link</b>	✓
VendorID	26
DeviceID HEX	800091
DeviceID DEC	8388753
<b>Cycle time</b>	2.3 ms

### Ambient data

<b>Shock load</b>	According to EN 60068-2-27
<b>UL File No.</b>	NRKH.E191603

### Classifications

<b>ECLASS 5.0</b>	27270909
<b>ECLASS 5.1.4</b>	27270909
<b>ECLASS 6.0</b>	27270909
<b>ECLASS 6.2</b>	27270909
<b>ECLASS 7.0</b>	27270909
<b>ECLASS 8.0</b>	27270909
<b>ECLASS 8.1</b>	27270909
<b>ECLASS 9.0</b>	27270909
<b>ECLASS 10.0</b>	27270909
<b>ECLASS 11.0</b>	27270909
<b>ECLASS 12.0</b>	27270909
<b>ETIM 5.0</b>	EC002720
<b>ETIM 6.0</b>	EC002720
<b>ETIM 7.0</b>	EC002720
<b>ETIM 8.0</b>	EC002720
<b>UNSPSC 16.0901</b>	39121528

### Dimensional drawing (Dimensions in mm (inch))

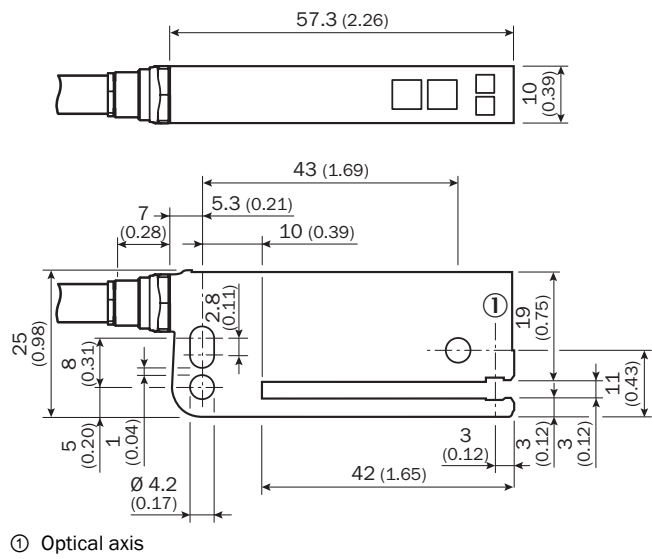
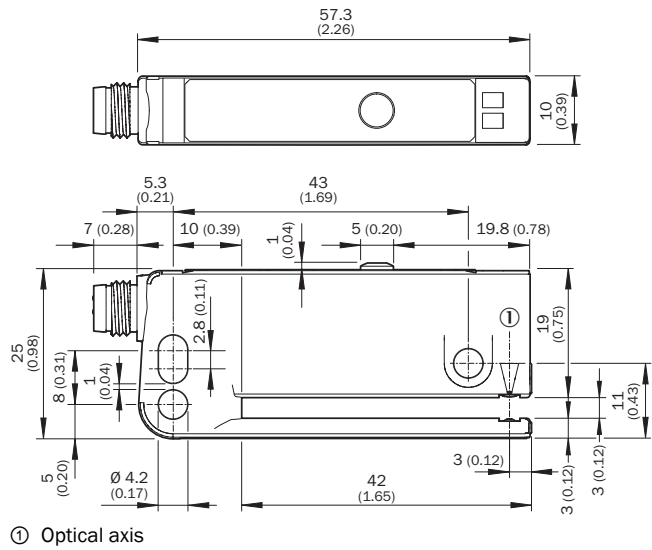

## Adjustments

Adjustment: teach-in via Teach-in button (Wfxx-B41Cxx)

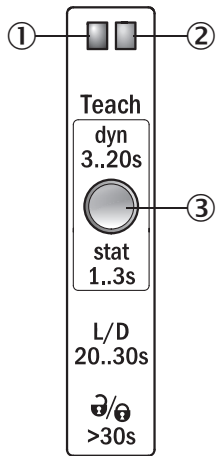

- ① Function signal indicator (yellow), switching output
- ② Function signal indicator (green)
- ③ Teach-in button and function button

## Connection diagram

Cd-314

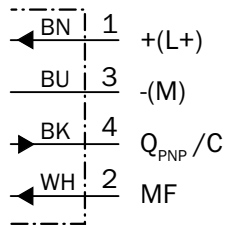

### Concept of operation

Teach-in dynamic via Teach-in button

#### 1. Start teach-in: Position carrier or label between the fork

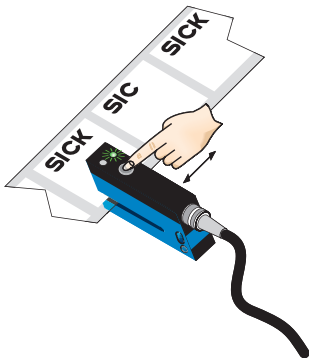

Press the teach-in button for 3 - 20 s. With the pushbutton pressed down, move several label with carrier material (label) through the sensor. The yellow LED flashes at 3 Hz during the teach-in procedure. Recommendation: Move at least 3 label + carrier through the sensor.

#### 2. End teach-in:

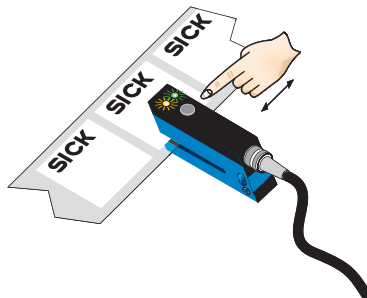

Release the teach-in button for < 20 s. If teach-in is successful, the function indicator (yellow LED) directly indicates the output state of the sensor. The switching threshold is now optimally set between carrier and label. The best possible operational safety is provided.

### Note

#### Fine adjustment

In order to obtain a higher operating reserve, a fine adjustment can be carried out after successful teach-in. For this purpose, the switching threshold is set close to the taught-in object. The teach-in button must be pressed and released within 10 s of successful teach-in. Successful setting is signaled by flashing twice at 1 Hz.

#### Light/dark switching









- You can change between light switching and dark switching by pressing the teach-in button for 20 - 30 s.

#### Pushbutton lock

- The device can be locked against unintended operation by pressing the teach-in button for > 30 s. The device can be unlocked by pressing the teach-in button again for > 30 s.

## Recommended accessories

Other models and accessories → [www.sick.com/WFS](http://www.sick.com/WFS)

	Brief description	Type	Part no.
<b>Cloning modules</b>			
	IO-Link version V1.1, Port class 2, PIN 2, 4, 5 galvanically connected, Supply voltage 18 V DC ... 32 V DC (limit values, operation in short-circuit protected network max. 8 A)	IOLP2ZZ-M3201 (SICK Memory Stick)	1064290
	IO-Link V1.1 Class A port, USB2.0 port, optional external power supply 24V / 1A	IOLA2US-01101 (SiLink2 Master)	1061790
	EtherCAT IO-Link Master, IO-Link V1.1, Port Class A, power supply via 7/8" cable 24 V / 8 A, fieldbus connection via M12 cable	IOLG2EC-03208R01 (IO-Link Master)	6053254
<b>Universal bar clamp systems</b>			
	WFS mounting rod, straight, including 2 x fixing screws, Aluminum	BEF-M12GF-A	2059414
	Bar clamp for bar diameter of 12 mm (fixing the mounting rod), Aluminum, 2 screws M6 x 30, 2 spring discs	BEF-RMC-D12	5321878
<b>Plug connectors and cables</b>			
	<ul style="list-style-type: none"> <li><b>Connection type head A:</b> Female connector, M8, 4-pin, straight, A-coded</li> <li><b>Connection type head B:</b> Flying leads</li> <li><b>Signal type:</b> Sensor/actuator cable</li> <li><b>Cable:</b> 5 m, 4-wire, PVC</li> <li><b>Description:</b> Sensor/actuator cable, unshielded</li> <li><b>Application:</b> Zones with chemicals</li> </ul>	YF8U14-050VA3XLEAX	2095889
	<ul style="list-style-type: none"> <li><b>Connection type head A:</b> Female connector, M8, 4-pin, straight, A-coded</li> <li><b>Connection type head B:</b> Male connector, M12, 4-pin, straight, A-coded</li> <li><b>Signal type:</b> Sensor/actuator cable</li> <li><b>Cable:</b> 5 m, 4-wire, PVC</li> <li><b>Description:</b> Sensor/actuator cable, unshielded</li> <li><b>Application:</b> Zones with chemicals</li> </ul>	YF8U14-050VA3M2A14	2096609
	<ul style="list-style-type: none"> <li><b>Connection type head A:</b> Male connector, M8, 4-pin, straight</li> <li><b>Description:</b> Unshielded</li> <li><b>Connection systems:</b> Screw-type terminals</li> <li><b>Permitted cross-section:</b> 0.14 mm<sup>2</sup> ... 0.5 mm<sup>2</sup></li> </ul>	STE-0804-G	6037323
<b>Sensor Integration Gateway</b>			
	<ul style="list-style-type: none"> <li><b>Further functions:</b> Web server integrated, USB connection for easy configuration of the SIG200 Sensor Integration Gateway with SOPAS ET, the engineering tool from SICK, logic editor is available for easy configuration of logic functions</li> <li><b>Connection CONFIG:</b> 1 x M8, 4-pin female connector, USB 2.0 (USB-A)</li> <li><b>Logic editor:</b> yes</li> <li><b>Communication interface:</b> IO-Link, USB, Ethernet, PROFINET, REST API</li> <li><b>Product category:</b> IO-Link Master</li> </ul>	SIG200-0A0412200	1089794
	<ul style="list-style-type: none"> <li><b>Further functions:</b> Web server integrated, USB connection for easy configuration of the SIG200 Sensor Integration Gateway with SOPAS ET, the engineering tool from SICK, logic editor is available for easy configuration of logic functions</li> <li><b>Connection CONFIG:</b> 1 x M8, 4-pin female connector, USB 2.0 (USB-A)</li> <li><b>Logic editor:</b> yes</li> <li><b>Communication interface:</b> IO-Link, USB, Ethernet, REST API</li> <li><b>Product category:</b> IO-Link Master</li> </ul>	SIG200-0A0G12200	1102605

### Recommended services

Additional services → [www.sick.com/WFS](http://www.sick.com/WFS)

	Type	Part no.
Function Block Factory		
<ul style="list-style-type: none"><li>• <b>Description:</b> The Function Block Factory supports common programmable logic controllers (PLCs) from various manufacturers, such as Siemens, Beckhoff, Rockwell Automation and B&amp;R. More information on the FBF can be found <a _blank"="" href="https://fbf.cloud.sick.com target=">here</a>.</li><li>• <b>Note:</b> You can configure your function block at <a _blank"="" href="https://fbf.cloud.sick.com target=">Function Block Factory</a>. As a login please use your SICK ID.</li></ul>	Function Block Factory	On request



## SICK AT A GLANCE

SICK is one of the leading manufacturers of intelligent sensors and sensor solutions for industrial applications. A unique range of products and services creates the perfect basis for controlling processes securely and efficiently, protecting individuals from accidents and preventing damage to the environment.

We have extensive experience in a wide range of industries and understand their processes and requirements. With intelligent sensors, we can deliver exactly what our customers need. In application centers in Europe, Asia and North America, system solutions are tested and optimized in accordance with customer specifications. All this makes us a reliable supplier and development partner.

Comprehensive services complete our offering: SICK LifeTime Services provide support throughout the machine life cycle and ensure safety and productivity.

For us, that is “Sensor Intelligence.”

## WORLDWIDE PRESENCE:

Contacts and other locations –[www.sick.com](http://www.sick.com)