

Canalis KT

Busbar Trunking System

Installation Manual for Volkswagen Group

11/2018

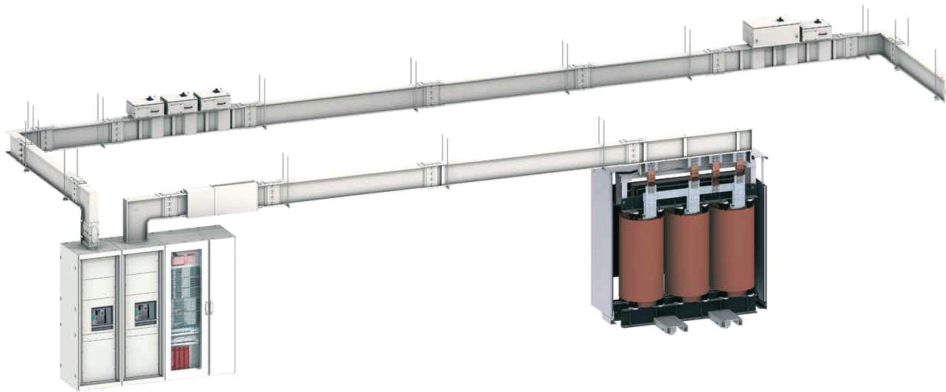

The information provided in this documentation contains general descriptions and/or technical characteristics of the performance of the products contained herein. This documentation is not intended as a substitute for and is not to be used for determining suitability or reliability of these products for specific user applications. It is the duty of any such user or integrator to perform the appropriate and complete risk analysis, evaluation and testing of the products with respect to the relevant specific application or use thereof. Neither Schneider Electric nor any of its affiliates or subsidiaries shall be responsible or liable for misuse of the information contained herein. If you have any suggestions for improvements or amendments or have found errors in this publication, please notify us.

You agree not to reproduce, other than for your own personal, noncommercial use, all or part of this document on any medium whatsoever without permission of Schneider Electric, given in writing. You also agree not to establish any hypertext links to this document or its content. Schneider Electric does not grant any right or license for the personal and noncommercial use of the document or its content, except for a non-exclusive license to consult it on an "as is" basis, at your own risk. All other rights are reserved.

All pertinent state, regional, and local safety regulations must be observed when installing and using this product. For reasons of safety and to help ensure compliance with documented system data, only the manufacturer should perform repairs to components.

When devices are used for applications with technical safety requirements, the relevant instructions must be followed.

Failure to use Schneider Electric software or approved software with our hardware products may result in injury, harm, or improper operating results.

Failure to observe this information can result in injury or equipment damage.

© 2018 Schneider Electric. All rights reserved.

Table of Contents



	Safety Information	5
	About the Book	7
Chapter 1	Preparation and Organization	9
	Equipment and Tools	10
	Reception and Handling	12
	Layout, Missing Links, and Pre-Installation Checks	14
	Phase Order Check	15
	Run Component Dimensions	18
	Minimum Distances from Walls and Ceilings	19
	Electrical Safety Instructions	20
Chapter 2	Installation of Supports and Run Components	21
	General Rules for Installing Supports	22
	Installation of Horizontal Runs	25
	Installation of Horizontal Run Components on Supports	27
	Installation of Joint Blocks	30
	Installation of Vertical Runs	33
Chapter 3	Transformer Connections	37
	Connection to Oil-Immersed Transformers	38
	Connection to Dry-Type Transformers	40
	Connection to Trihal Dry-Type Transformers	42
Chapter 4	Switchboard Connections	45
	Connection to Switchboards	46
	Connection to Prisma P and Okken Switchboards	49
Chapter 5	Installation of Tap-Off Units	53
	Installation of Plug-In Tap-Off Units	54
	Installation of Bolted Tap-Off Units	58
Chapter 6	Installation of Specific Components	61
	Installation of Expansion Units	62
	Installation of Fire-Barrier Kit	65
Chapter 7	Commissioning and Maintenance	67
	Commissioning	68
	Commissioning Check-list Before Energizing	71
	Maintenance	73
Appendices		75
Appendix A	Related Documents	77
	List of Instruction Sheets	77
Appendix B	Components for Volkswagen Group	81
	Installation of KTB0244ZA6 Top Supports	82
	Installation of KH040SD9502 or KH063SD9502 Plug-In Tap-Off Units	83
	Installation of KTA2500GK•1 Grounding Kits and KTA2500RL•• Coupling Isolators	86
	List of Instruction Sheets	87



Important Information

NOTICE

Read these instructions carefully, and look at the equipment to become familiar with the device before trying to install, operate, service, or maintain it. The following special messages may appear throughout this documentation or on the equipment to warn of potential hazards or to call attention to information that clarifies or simplifies a procedure.



The addition of this symbol to a “Danger” or “Warning” safety label indicates that an electrical hazard exists which will result in personal injury if the instructions are not followed.



This is the safety alert symbol. It is used to alert you to potential personal injury hazards. Obey all safety messages that follow this symbol to avoid possible injury or death.

DANGER

DANGER indicates a hazardous situation which, if not avoided, **will result in** death or serious injury.

WARNING

WARNING indicates a hazardous situation which, if not avoided, **could result in** death or serious injury.

CAUTION

CAUTION indicates a hazardous situation which, if not avoided, **could result in** minor or moderate injury.

NOTICE

NOTICE is used to address practices not related to physical injury.

PLEASE NOTE

Electrical equipment should be installed, operated, serviced, and maintained only by qualified personnel. No responsibility is assumed by Schneider Electric for any consequences arising out of the use of this material.

A qualified person is one who has skills and knowledge related to the construction and operation of electrical equipment and its installation, and has received safety training to recognize and avoid the hazards involved.

Essential Safety Instructions

WARNING

HAZARD OF CRUSHING AND FRACTURES

- Wear personal protective equipment when handling and installing the products (long sleeved jacket, trousers, gloves, safety shoes, helmet, and safety glasses).
- Only personnel who have been trained in safety regulations may work on construction sites to install busbar trunking systems.
- Work with extreme caution and follow the instructions provided in the manual.

Failure to follow these instructions can result in death, serious injury, or equipment damage.



About the Book



At a Glance

Document Scope

This manual provides instructions for the installation of the Canalis KT busbar trunking system. This manual contains the following:

- The preliminary requirements for the installation of the Canalis KT busbar trunking system.
- The installation procedures of the Canalis KT components.
- The installation procedures of Canalis KT components specific to Volkswagen Group (*see page 81*).
- The recommendations for commissioning and maintenance of the Canalis KT system.

This manual is intended for trained personnel.

Validity Note

For product compliance and environmental information (RoHS, REACH, PEP, EOLI, etc.), go to www.schneider-electric.com/green-premium.

The information contained in this document is likely to be updated at any time. Schneider Electric strongly recommends that you have the most recent and up-to-date version available on www.schneider-electric.com/docs.

The technical characteristics of the devices described in the present document also appear online. To access the information online:

Step	Action
1	Go to the Schneider Electric home page www.schneider-electric.com .
2	In the Search box type the reference of a product or the name of a product range. <ul style="list-style-type: none">• Do not include blank spaces in the reference or product range.• To get information on grouping similar modules, use asterisks (*).
3	If you entered a reference, go to the Product Datasheets search results and click on the reference that interests you. If you entered the name of a product range, go to the Product Ranges search results and click on the product range that interests you.
4	If more than one reference appears in the Products search results, click on the reference that interests you.
5	Depending on the size of your screen, you may need to scroll down to see the data sheet.
6	To save or print a data sheet as a .pdf file, click Download XXX product datasheet .

The characteristics that are presented in the present document should be the same as those characteristics that appear online. In line with our policy of constant improvement, we may revise content over time to improve clarity and accuracy. If you see a difference between the document and online information, use the online information as your reference.

Related Documents

Title of Documentation	Reference Number
Canalis KTA Catalogue	DEBU021EN
Canalis KTC Catalogue	DEBU024EN

You can download these technical publications and other technical information from our website at <https://www.schneider-electric.com/en/download>

Instruction Sheets

The list of instruction sheets for the installation of the Canalis KT busbar trunking system can be found in Appendix A (*see page 77*).

Chapter 1

Preparation and Organization

What Is in This Chapter?

This chapter contains the following topics:

Topic	Page
Equipment and Tools	10
Reception and Handling	12
Layout, Missing Links, and Pre-Installation Checks	14
Phase Order Check	15
Run Component Dimensions	18
Minimum Distances from Walls and Ceilings	19
Electrical Safety Instructions	20

Equipment and Tools

Introduction

Listed here are the necessary tools, equipment, and supplies that you must have available before you can begin the installation of the Canalis KT busbar trunking system.

Lifting and Handling Equipment



Crane or forklift truck with minimum fork length of 2 m, capable of lifting 1.5 tons (minimum).



Two slings for handling the components.

NOTE: The lifting and handling equipment required may vary, depending on the configuration of the site.

Equipment for Positioning and Installing Supports



Drilling machine capable of drilling through concrete.



Set of flat or ring spanners (10...22 mm).



Socket wrench with sockets (10...22 mm).



Set of screwdrivers.



Carpenters square.



Measuring tape (metric).



Insulation tester (Megohmmeter (1000 Vdc)).



Leveling instrument (spirit level).



Torque wrench (10...100 N•m,
10...22 mm).

Reception and Handling

Introduction

The Canalis KT system includes the following components:

- Run components including straight lengths, elbows, zed units, and tees.
- Joint blocks.
- Expansion units.
- Tap-off units.
- Supports.
- Feed units for transformers and switchboards.
- Sealing kits.
- Protective covers for transformers.
- Cable boxes.
- Coupling isolators.
- Connection accessories.

Scope of Delivery

All materials are packaged and sent with a delivery note, a packing list, and short installation instructions.

Receiving the Materials

Follow these instructions after the materials are received:

- Note the information symbols and labels on the packaging. Pay attention to safety labels.
- Check that the documentation and materials correspond to your installation project.
- Check that the material is in proper condition and without transport or water damage.
- Check that all the materials ordered are supplied and they function as indicated in the documentation.

NOTE: Claims for defective or damaged materials in the shipment must be made in writing to Schneider Electric within 30 days of receipt of the shipment. Schneider Electric is not responsible for repair or replacement if the claim is not made within 30 days of the receipt of the shipment.

Proper Handling of Materials

NOTICE

HAZARD OF BREAKAGE

- Proceed with caution and pay attention to personnel safety. Use equipment necessary for correct handling.
- Avoid damaging the metal housing on the run components.
- Avoid using abrasive or metal slings for lifting the run components.
- Avoid using steel cables or hooks for lifting the run components.
- Avoid using the ends of the run components for lifting.
- Avoid dragging the run components on the ground.

Failure to follow these instructions can result in equipment damage.

The Canalis KT components must be handled with care. This is important to avoid damage to the interior of the components, the external appearance, or to the conductors at the ends of the run components.

Follow these instructions while handling the Canalis KT components:

- Avoid subjecting the components to twisting, denting, impact, and other forms of rough handling.
- Check that the handling equipment at the installation site is adequate for handling the components.
- Check the lifting capacity of the crane or other equipment available.
- Use nylon straps to distribute the weight of the components when hoisting with a crane.
- Position the component on the fork to distribute the weight properly when using a forklift.
- Insert spreaders to avoid damage to the components when using cables.

Unpacking

The Canalis KT components must be unpacked carefully to avoid damage to the components. Follow these instructions for correct unpacking to avoid damage:

Step	Action	
1	Use nail pullers for unpacking and band cutters to cut the bands that secure the packaging.	
2	Use correct tools to remove the reinforced steel packing at the end of the run components.	
3	Discard the packaging.	

Storage

NOTICE

HAZARD OF EQUIPMENT DAMAGE

Do not store the Canalis KT components outdoors. The components are not weather resistant.

Failure to follow these instructions can result in equipment damage.

If the Canalis KT components are not installed immediately, follow these instructions for correct storage to avoid damage:

- Store the components in the original packing, in a clean, dry space with a constant temperature.
- If outdoor storage is unavoidable, cover the components securely to protect them from harsh environments. Provide temporary electrical heating under the cover to prevent condensation. The temperature must be suitable and the heating evenly distributed under the cover.

Layout, Missing Links, and Pre-Installation Checks

Layout

Before beginning installation, you must compare the plan which you received from the design office (or Schneider Electric), with the actual layout of the building.

Specific points about the layout:

- Check that the floors, walls and ceilings where supports are to be positioned are strong enough to handle the weight. Floors, walls, and ceilings should be made of metal or concrete.
- Check that there is no other equipment in the way of the run (HVAC, plumbing, or others).

Identifying the Locations of Missing Links

Missing links are gaps in sections of straight lengths of run components. They are sometimes introduced to ease the installation process and to optimize the system according to on-site constraints. Be aware of these missing links and their locations on-site.

For long runs, it is often difficult to plan the dimensions of the missing links. In these cases, the run components to fill the missing links are ordered at the end of the installation after the gaps to be filled have been measured.

Pre-Installation Check

Schneider Electric recommends that you perform an insulation test on the run components before installation. This is to check for damage or contamination during shipment or storage.

When the rated operating voltage $U_e < 500 \text{ Vac}$, perform an insulation test on each run component as follows:

- Using a megohmmeter of at least 500 Vdc (DC to avoid inductive and capacitive currents), make measurements between active conductors and exposed conductive parts (phase-to-phase, phase-to-neutral, phase-to-ground, and neutral-to-ground).
- The test is satisfactory if the insulation resistance between active conductors and exposed conductive parts is at least $1000 \Omega/\text{V}$ per circuit, referred to the supply voltage to ground of these circuits.

NOTE: When the rated operating voltage $U_e > 500 \text{ Vac}$, perform the test at 1000 Vdc. The insulation resistance must be not less than 1 M Ω .

Phase Order Check

Checking the Phase Order

⚡ ⚠ DANGER

HAZARD OF ELECTRIC SHOCK

Wrong phase order can result in short circuit.

Failure to follow these instructions will result in death or serious injury.

Perform the following phase order checks:

- Check the phase order of the layout and the existing connected equipment (for example, transformers and switchboards).
- Check the phase order of the run components before installation. This is important for the correct installation of the run, as the Canalis KT run components are asymmetric. You can check the phase order by:
 - Locating and aligning the neutral conductor.
 - Checking the labels on the run components.
- Check whether the reinforced protective earth (PER) is being used.
- Check the phase orders of end feed units.

Locating and Aligning the Neutral Conductor

For the rules for locating and aligning the neutral conductor, consult the instruction sheet [AAV32038](#) available on the Schneider Electric website.

The position of the neutral conductor is indicated by a slot which is located on the opposite side of the run component to the neutral conductor.

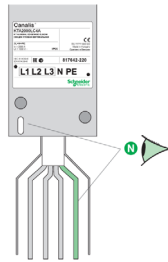

Check the alignment of the neutral conductors by checking that the slots are aligned on the same side.

Correct alignment.

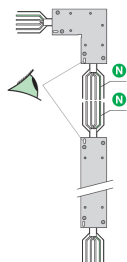

Incorrect alignment.

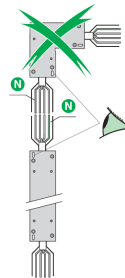

NOTE: The mismatch protection of Canalis KT system does not allow the assembly of two run components if the neutral conductors are not on the same side.

Checking the Labels on the Run Components

The labels on the run components provide information about the phase order, polarity, and the dimensions.

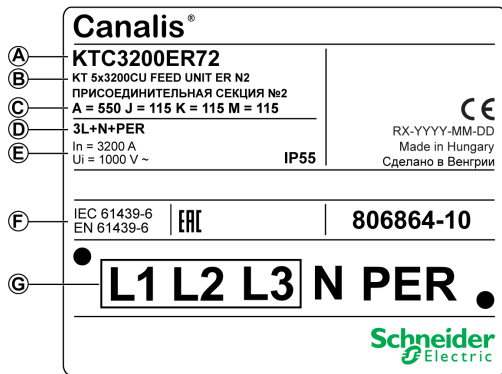

- A Commercial reference
- B Product description
- C Product dimensions
- D Polarity
- E Product rating
- F Standard specifications (IEC / EN)
- G Phase order

Checking for Changes in the Phase Order Using the Labels on the Run Components

The standard phase order N321 is shown on the label as L1 L2 L3 N.

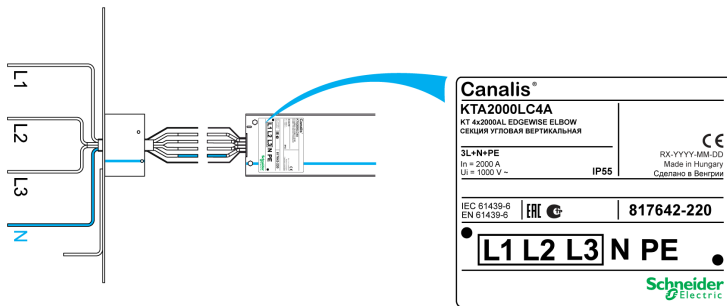

If the standard phase order is changed to N123, a changed label showing L3 L2 L1 N must be stuck over the phase order indication on the run component label, as shown in the following graphic. The changed label is supplied with each joint block.

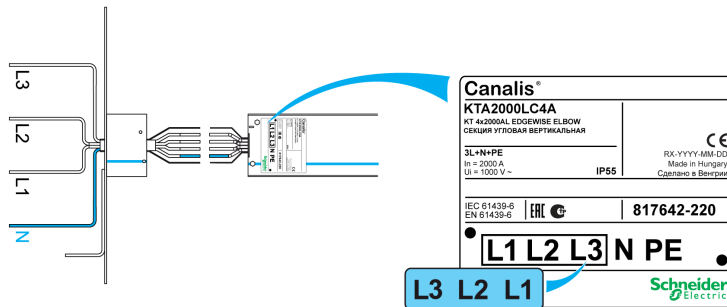

Reinforced Protective Earth (PER)

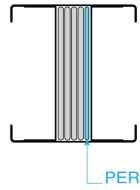

The reinforced protective earth (PER) conductor version of the busbar trunking system, 3L + N + PER, is fitted with an additional internal conductor with a cross-section equal to half that of the phase conductor. You must check for the alignment of this conductor between run conductors during installation. The reinforced conductor has an additional 3 mm on the PER conductor and is located on the same side as the neutral conductor.

Information about the installation of PER in a Prisma P or Okken switchboard can be found in the relevant chapter (*see page 50*).

Checking the Phase Order of the End Feed Units

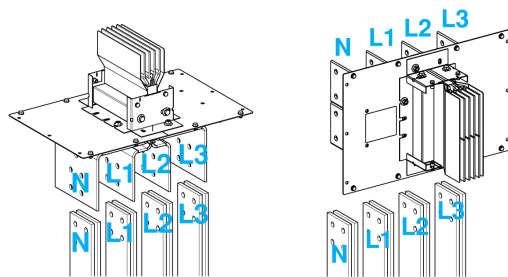

During installation, you must compare the phase order of any transformer or switchboard that is fed by an end feed unit, with the phase order of the end feed unit. This is necessary to enable the proper alignment of the conductors before making connections.

Run Component Dimensions

Introduction

The dimensions of the different run components, straight lengths, flat elbows, edgewise elbows, flat zed units, and edgewise zed units, are indicated on the labels.

Dimensions of Straight Lengths - Edgewise and Flatwise

The length L of a straight length is the distance in millimetres between the vertical axes located on either side of the run component. The vertical axis is located 20 mm from the end of the conductor. The length can be found on the label.

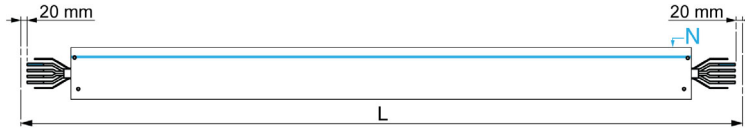

Dimensions of Direction-Changing Run Components

For flat and edgewise elbows, the dimensions are defined by the values of A and B. For flat and edgewise zed units, the dimensions are defined by the values of A, B, and C. The values can be found on the label.

Flat elbow:

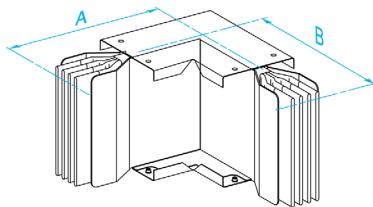

Edgewise elbow:

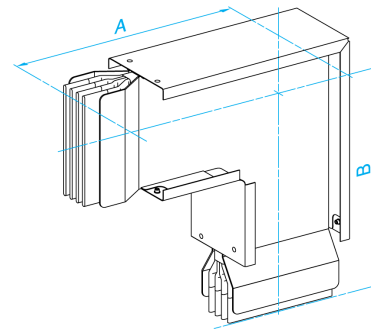

Flat zed unit:

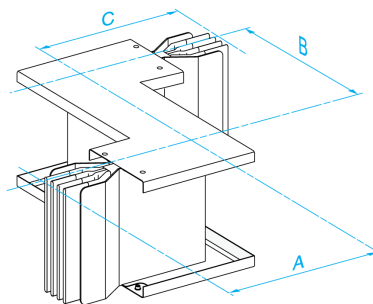

Edgewise zed unit:

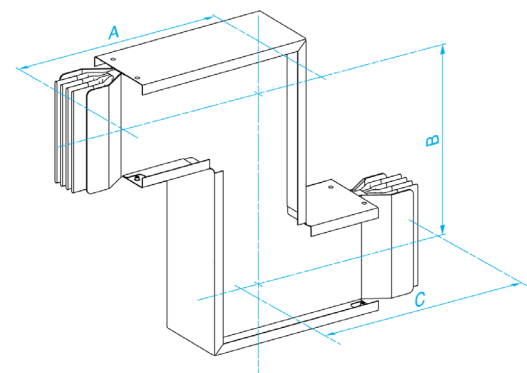

Minimum Distances from Walls and Ceilings

Edgewise Installation

Follow these rules for maintaining recommended minimum distances from walls and ceilings in edgewise installations of the run components:

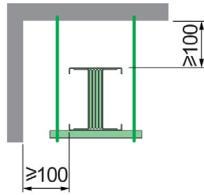

For run components installed edgewise:

- Maintain a minimum clearance distance of 100 mm from the top of the run components to the ceiling.
- Maintain a minimum clearance distance of 100 mm from the side of the run components to the wall.

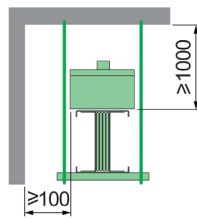

For run components installed edgewise with a tap-off unit:

- Maintain a minimum clearance distance of 1000 mm from the top of the run components to the ceiling.

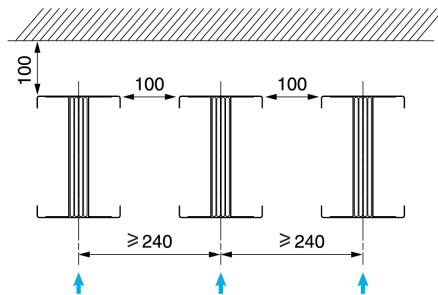

For multiple runs of Canalis KT run components:

- Maintain a minimum distance of 240 mm between the centres of the run components.
- Maintain a minimum distance of 100 mm between the run component ducts.
- Maintain a minimum distance of 100 mm between the ceiling and run component ducts.

Blue arrows show the direction of fitting the joint blocks.

NOTE: The minimum distances are necessary to enable the correct installation of the joint block.

Flatwise Installation

Follow these rules for maintaining recommended minimum distances from walls and ceilings in flatwise installations of the run components:

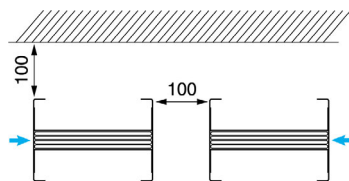

For run components installed flatwise:

- Maintain a minimum clearance distance of 100 mm from the top of the run components to the ceiling.
- Maintain a minimum clearance distance of 100 mm between the run components.

Blue arrows show the direction of fitting the joint blocks.

NOTE: The minimum distances are necessary to enable the correct installation of the joint block.

Electrical Safety Instructions

Introduction

During the installation, commissioning, and maintenance of the Canalis KT busbar trunking system, it is very important to observe general electrical safety instructions. These instructions apply to all the installation, connection, commissioning, and maintenance procedures described in this manual.

Safety Instructions

 DANGER
HAZARD OF ELECTRIC SHOCK, EXPLOSION OR ARC FLASH
<ul style="list-style-type: none">● Apply appropriate personal protective equipment (PPE) and follow safe electrical work practices. See NFPA 70E, CSA Z462, NOM 029-STPS or local equivalent.● Only qualified electrical maintenance personnel should install, operate, service or maintain this equipment.● Turn off all power supplying this equipment before working on or inside equipment.● Always use a properly rated voltage sensing device to confirm power is off.● Replace all devices, doors, and covers before turning on power to this equipment.● Beware of potential hazards, and carefully inspect the work area for tools and objects that may have been left inside the equipment.
Failure to follow these instructions will result in death or serious injury.

Chapter 2

Installation of Supports and Run Components

What Is in This Chapter?

This chapter contains the following topics:

Topic	Page
General Rules for Installing Supports	22
Installation of Horizontal Runs	25
Installation of Horizontal Run Components on Supports	27
Installation of Joint Blocks	30
Installation of Vertical Runs	33

General Rules for Installing Supports

Safety Instructions

 CAUTION
<p>HAZARD OF IMPROPER INSTALLATION</p> <ul style="list-style-type: none"> • Study and understand the layout plan before installing the supports. • Take into account the recommended separation distance between the supports during installation. • The supports must be levelled, so that the run components are level after installation. • The supports must be able to bear the weight of the run components. <p>Failure to follow these instructions can result in injury or equipment damage.</p>

Introduction

For proper installation of the Canalis KT run components, it is important to install supports correctly. There are some general rules which you must follow when installing supports for the Canalis KT run components.

General Rules

Follow these general rules for installing supports:

- No run component must be left unsupported.
- For easier leveling, always use at least two supports for each run component wherever possible.
- The supporting capacity of the support must be at least the weight of the run component plus 90 kg, in accordance with IEC 61439-6.
- Components at the terminal ends of the run must be supported by separate supports. The weight of end components must not be carried by transformers or switchboards.
- Vertical branches must be always supported as close as possible to the elbow angle.
- Elbows and zed units must be supported individually.
- Supports must be installed close to joint blocks. However, a support must never be positioned directly under a joint block.

Edgewise horizontal installation:

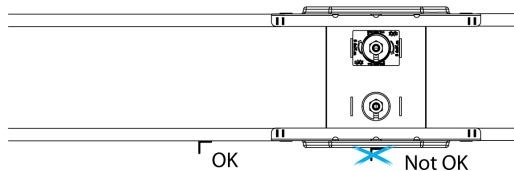

Flatwise horizontal installation:

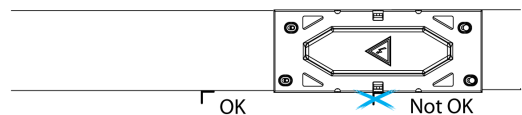

Supports for Edgewise Installation

For edgewise installations, the maximum recommended distance between supports is 3000 mm. In all cases, two supports must be provided for 4000 mm sections.

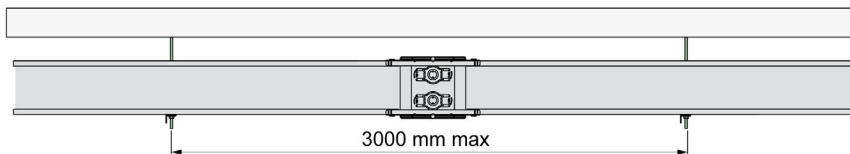

Supports for Flatwise Installation

For flatwise installations, the maximum recommended distance between supports is 2000 mm. In addition, a support must be placed at a maximum distance of 400 mm from the joint block axis.

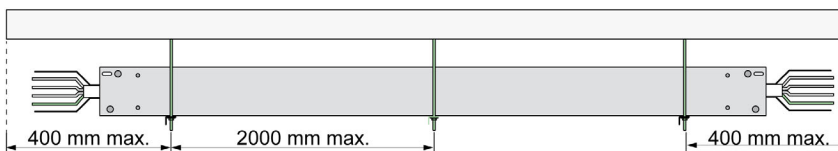

Supports for LC Elbows

LC elbows (height 244 mm to 404 mm) must have a support installed across the elbow angle.

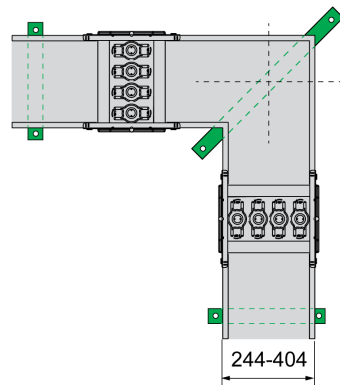

Supports for TC Tees

TC tees (height 324 mm to 404 mm) must have a support installed across the T-joint.

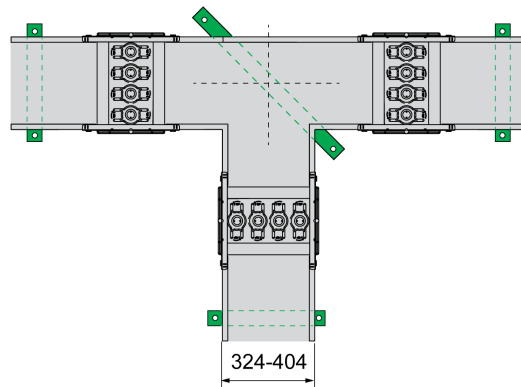

Supports for LC Edgewise Elbows With a Vertical Branch

Follow these rules to support LC edgewise elbows with a vertical branch:

- LC elbows must be supported from the top if the distance between the angle and the centre of the nearest joint block is less than 350 mm.

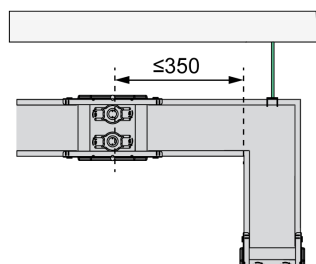

- LC elbows must be supported from the bottom if the distance between the angle and the centre of the nearest joint block is greater than 350 mm.

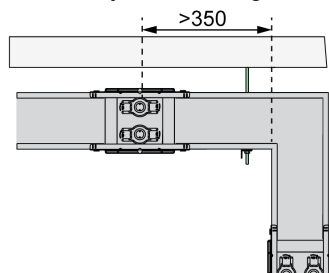

Supports for LP Flatwise Elbows With a Vertical Branch

LP flatwise elbows with a vertical branch must be supported close to the angles.

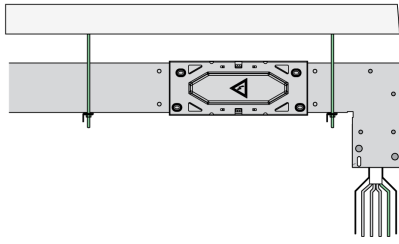

Installation of Horizontal Runs

Introduction

Follow these stages to install a horizontal run:

Stage	Description
1	Install the supports (<i>see page 25</i>).
2	Install the run components on the supports (<i>see page 27</i>).
3	Install the joint blocks (<i>see page 30</i>).

Horizontal Supports

Horizontal supports allow run components to be installed horizontally and adjusted along the length. They also help absorb any movement of the run components. Horizontal supports can be installed on the ceiling or the wall.

Types of Horizontal Supports

Before installing the horizontal supports, consult the general installation rules (*see page 22*).

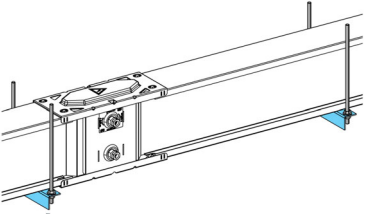
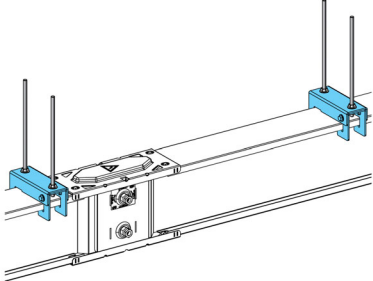
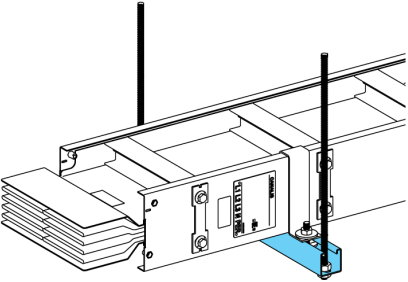
Horizontal support	Characteristics	Catalogue number
	<ul style="list-style-type: none"> Attached to the ceiling using 2x2 m threaded M10 rods (provided by Schneider Electric). Provide support for edgewise run components from the bottom. 	KTB0000ZA1
	<ul style="list-style-type: none"> Attached to the ceiling using rods (not provided by Schneider Electric). Provide support for edgewise run components from the top. Installation instructions available in the instruction sheet AAV32042 available on the Schneider Electric website. 	KTB0074ZA4 KTB0404ZA4
	<ul style="list-style-type: none"> Attached to the ceiling using 2 meters rods supplied with the support. Provide support for flatwise run components from the bottom. 	KTB****ZA7

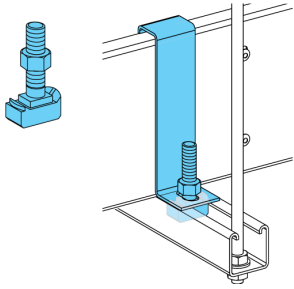
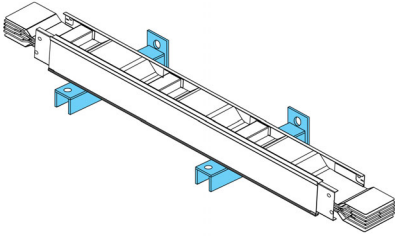
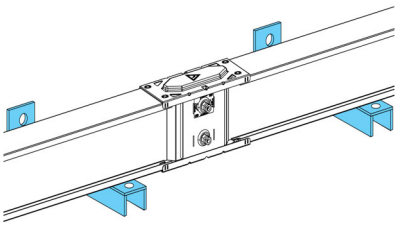
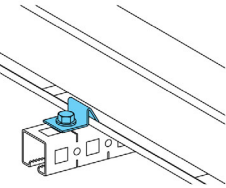
Horizontal support	Characteristics	Catalogue number
	<ul style="list-style-type: none"> • KTB0000ZA8 brackets are attached to KTB••••ZA7 supports with KTB0000YB6 T-bolts for flatwise horizontal installation. • Supports must be installed without blocking linear expansion of the busbar trunking. 	<p>KTB0000ZA8 KTB0000YB6</p>
	<ul style="list-style-type: none"> • Attached to the wall. • Provide support for flatwise run components from the bottom. • Supports not provided by Schneider Electric. 	<p>–</p>
	<ul style="list-style-type: none"> • Attached to the wall. • Provide support for edgewise run components from the bottom. • Supports not provided by Schneider Electric. 	<p>–</p>
	<ul style="list-style-type: none"> • Hooks attached to the support for edgewise horizontal installation. • Keep the busbar trunking in place on its support, without blocking it, in order to allow expansion movements. 	<p>KTB0000ZA3</p>

Installation of Horizontal Run Components on Supports

Introduction

Once the supports are installed, you can install the run components.

Procedure

The procedure for installing the run components is described in instruction sheets available on the Schneider Electric website:

- For Canalis KTA1000-4000/KTC1350-5000 run components: [AAV32038](#).
- For Canalis KTA5000/KTC6300 run components: [PHA33884](#).

Step	Action
1	Check that the installed supports are at the correct minimum distances from the walls and ceilings (<i>see page 19</i>).
2	Check that the supports for horizontal runs are installed correctly (<i>see page 22</i>).
3	Check the phase order and position of the neutral conductors of all the run components (<i>see page 15</i>).
4	Install the horizontal run components on the supports.
5	Compensate for the gaps due to the asymmetric profiles in KT•••ED•• and KT•••EH•• components (<i>see page 27</i>).
6	Adjust the distance between the ends of the run components. It must be 40 ± 2 mm, which is the space required to install the joint block.
7	Check the alignment of the run components with a 1-meter long leveling instrument. The maximum tolerance for misalignment is 2 mm to conform to the IP55 protection rating (<i>see page 28</i>).
8	Install the joint block (<i>see page 30</i>).

Installing Run Components for Tap-Off Units

NOTICE

HAZARD OF EQUIPMENT DAMAGE

Special care must be taken when positioning supports below run components dedicated to tap-off units, when the run components are installed flatwise:

- Supports should not be positioned in front of outlets or future tap-off units
- Spacers must be added between supports and run components to compensate for the asymmetry of their lateral profiles due to the extra size of the tap-off unit outlets

Failure to follow these instructions can result in equipment damage.

For KT•••EB•• run components, supports must be installed under the sheet metal enclosure. No spacers are required.

For KT•••ED•• and KT•••EH•• run components, spacers must be installed on supports to compensate for the gap so that the base of the component is parallel to the supports.

The gap to be compensated depends on:

- Whether the run component is installed with the neutral at the top or at the bottom.
- Whether the support is installed under the upper hood profile of the tap-off unit outlet (A) or the sheet metal enclosure (B).

KT•••ED•• run components:

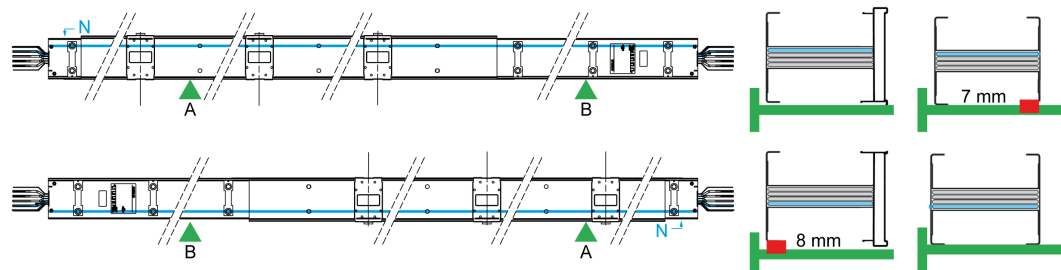

KT•••EH•• run components:

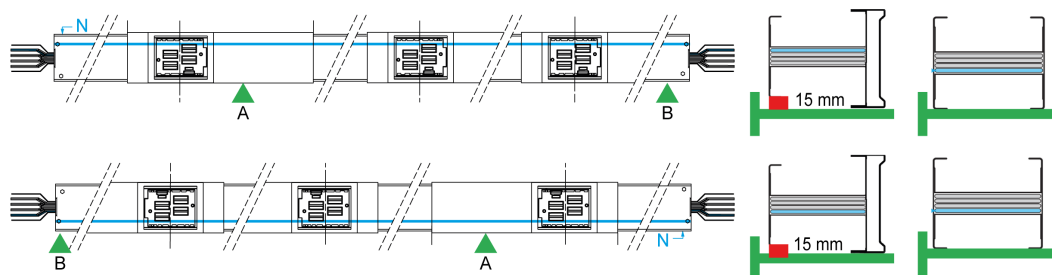

- Spacers
- ▲ Example of position of supports
- A** Support under upper hood profile of the tap-off unit outlet
- B** Support under sheet metal enclosure
- Position of neutral conductor

Aligning the Run Components

NOTICE

LOSS OF IP55 PROTECTION RATING

The run components must be correctly aligned.

Failure to follow these instructions can result in equipment damage.

The maximum tolerance for misalignment is 2 mm.

The alignment must be checked on both sides of the run components:

- Check alignment on the top of the run components:

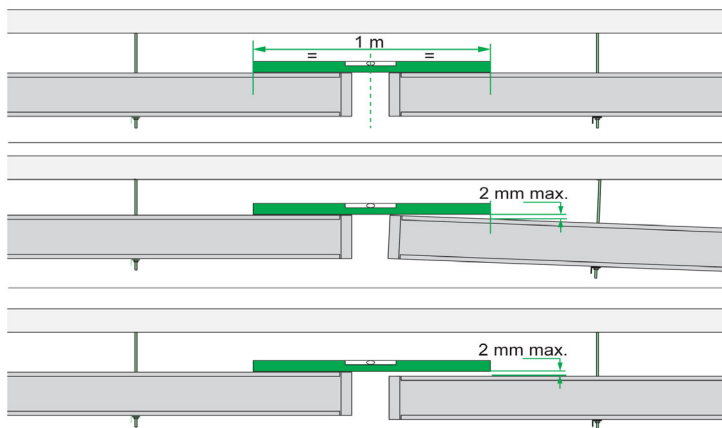

- Check alignment on the side of the run components:

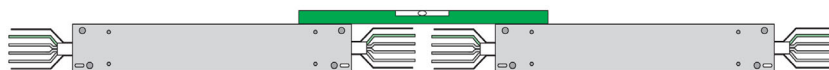

Installing KTA5000/KTC6300 Run Components

KTA5000 run components are made of two KTA2500 run components. KTC6300 run components are made of two KTC3200 run components. The two run components are linked together and they can be installed flatwise or edgewise.

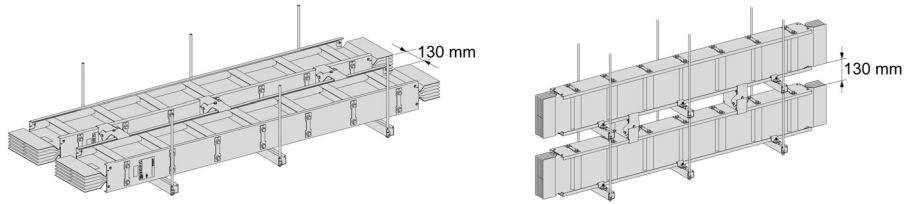

The procedure for installing Canalis KTA5000/KTC6300 run component is described in the instruction sheet [PHA33884](#), available on the Schneider Electric website.

Installation of Joint Blocks

Introduction

Once the two run components have been installed on the horizontal and vertical supports and aligned, you can install the joint block.

The joint block provides the following:

- Electrical junction between live conductors and between PE protective earth conductors.
- Mechanical link between two run components or sections. It provides simultaneous continuity between all the conductors.

Procedure

The procedure for installing the joint block is described in the instruction sheet [AAV32038](#), available on the Schneider Electric website.

Step	Action
1	Install the bottom cover under the aligned conductors of the two run components. Hand tighten the fixing screws.
2	Insert the joint block carefully between the two run components.
3	Check the alignment of the run components, joint blocks and PE conductors. <i>(see page 30)</i>
4	Check the alignment of the joint block and the gaskets of the top and bottom covers to conform to the IP55 protection rating <i>(see page 31)</i> .
5	Tighten the four fixing screws of the bottom cover to a torque of 10 N•m.
6	Install the top cover.
7	Tighten the four fixing screws of the top cover to a torque of 10 N•m.
8	Tighten the bolts of the joint block to a torque of 60 N•m, to provide the electrical connection <i>(see page 32)</i> .

Checking the Alignment of the PE Protective Earth Conductors

DANGER

HAZARD OF SHORT CIRCUIT

- The run components, joint blocks and PE conductors must be correctly aligned.
- The run component conductors and the metallic side of the PE conductor must be positioned correctly between the fishplates.

Failure to follow these instructions will result in death or serious injury.

The continuity of the PE conductors is established by the enclosure of the run component. You must check the correct position of the components, joint blocks, and PE conductors and the continuity of the PE conductors through the joint block:

Correct

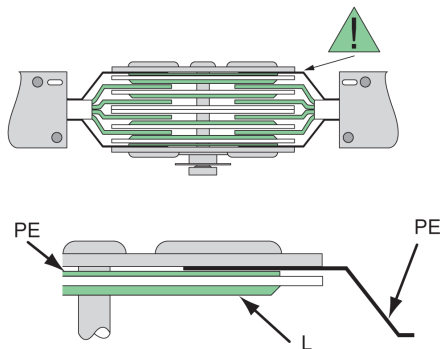

PE Protective earth conductor
L Fishplate

Incorrect

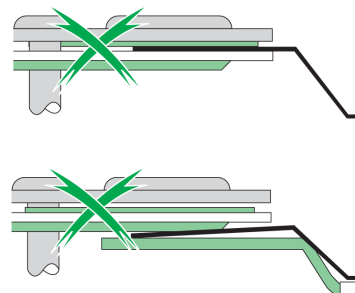

Checking the Alignment of the Joint Block and Covers

NOTICE

LOSS OF IP55 PROTECTION RATING

The joint block and the gaskets of the top and bottom covers must be correctly aligned for the system to conform to IP55 protection rating standards.

Failure to follow these instructions can result in equipment damage.

The alignment must be checked on both the joint block and the cover:

- Check the alignment of the joint block:

Correct

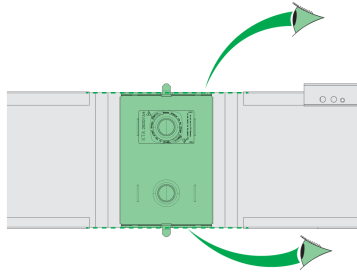

Incorrect

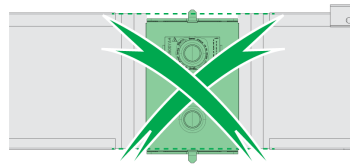

- Check the alignment of the cover gaskets:

Correct

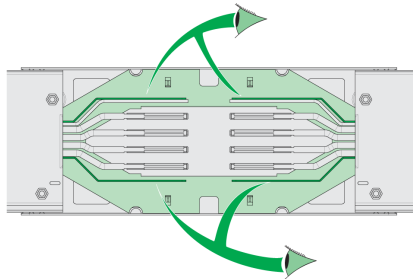

Incorrect

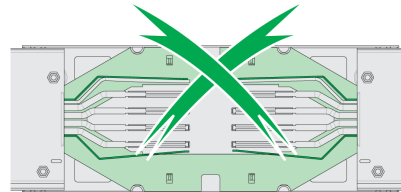

Rules for Tightening the Bolts of the Joint Block

Correct tightening of the bolts of the joint block enables the electrical connection through the run. Follow these rules when tightening the bolts:

- The connection bolts must be tightened to a torque of 60 N•m.

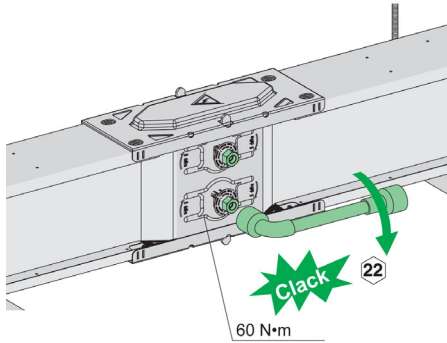

- When the correct tightening torque is reached, the nut head snaps off, freeing a red washer (shear nuts). The freed red washer falls off.

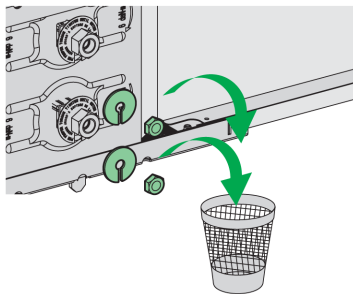

- The tightening has been done correctly only if the red washer is absent after the procedure.
- For dismantling or maintenance operations, the nut has a second head. If the joint block is dismantled and reassembled at installation or for maintenance, the torque of 60 N•m must be checked with a torque wrench.

Installation of Vertical Runs

Introduction

Vertical supports allow run components to be installed vertically and adjusted along the length. The spring allows the run component to remain attached to the wall bracket in case of expansion.

Vertical run component installations must always be made from bottom to top.

Vertical supports can be installed:

- On a wall, by using the KTB•••ZA52 wall brackets or customized wall brackets.

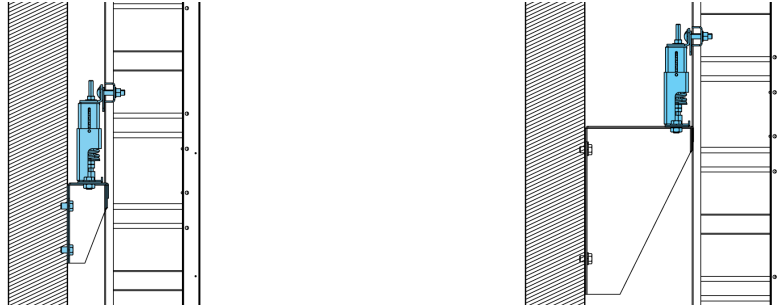

- On the floor, without any additional accessory.

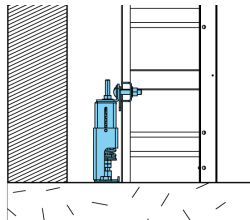

Types of Vertical Supports

There are two types of vertical supports. The type of support required depends on the rating of the busbar trunking system:

- A rear-wall fixing system, with one support attached to the run component and two brackets attached to the wall.

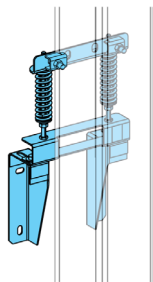

- A side-wall fixing system, with two supports attached to the run component and two brackets attached to the wall.

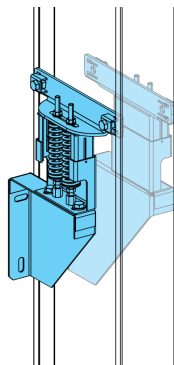

Ratings for Vertical Supports

The following table lists the ratings for vertical supports and wall brackets:

Ratings		Fixing type	Catalogue number	
KTA	KTC		Vertical support	Wall brackets
800 to 1600	1000 to 2000	Rear	KTB0164ZA51	KTB0164ZA52
2000	2500	Side	KTB0204ZA51	KTB0204ZA52
2500	3200	Side	KTB0244ZA51	KTB0244ZA52
3200	4000	Side	KTB0324ZA51	KTB0324ZA52
4000	5000	Side	KTB0404ZA51	KTB0404ZA52
5000	6300	Side	2xKTB0244ZA51	Not provided by Schneider Electric.

Procedure

The procedure for installing vertical supports and run components is described in instruction sheets available on the Schneider Electric website:

- For Canalis KT rear-wall fixing system: [PHA12613](#).
- For Canalis KT side-wall fixing system: [PHA12664](#).

Step	Action
1	Before installing the vertical supports, consult the general installation rules (see page 22).
2	Check that the adjoining run component directly below the one being installed is in place.
3	Set the spring compression value on the support. The value of the spring compression depends on the rating of the run component.
4	Attach the support to the run component by tightening the bolts to the correct torque.
5	Check that the width of the support is at right angles to the length of the run component
6	Use the template delivered with the support to drill the holes for mounting the wall brackets on the wall.
7	Mount the wall brackets on the wall.
8	Install the support of the run component on the wall bracket.
9	Attach the support using the screws supplied.
10	Check the distance between the end of the run component and the one directly below. It must be 40 ± 2 mm, which is the space required to install the joint block. If necessary, adjust the position of the support attached to the run component.
11	Align the run components with a 1-meter long leveling instrument. The maximum tolerance for misalignment is 2 mm to conform to the IP55 protection rating (see page 28).
12	Remove the nuts on the springs in the support that is fixed on the run component.
13	Install the joint block (see page 30).

Installing KTA5000/KTC6300 Run Components

KTA5000 run components are made of two KTA2500 run components. KTC6300 run components are made of two KTC3200 run components. Two KTB•••ZA51 vertical supports must be installed on each run component. The vertical supports are installed on a wall bracket not provided by Schneider Electric. They are linked together and can be installed flatwise or edgewise.

The procedure for installing Canalis KTA5000/KTC6300 run components is described in the instruction sheets [PHA33884](#) and [PHA12664](#) for side by side vertical support, available on the Schneider Electric website.

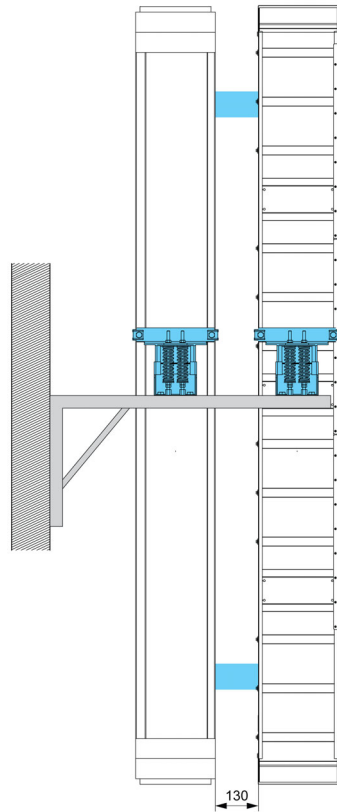

Chapter 3

Transformer Connections

What Is in This Chapter?

This chapter contains the following topics:

Topic	Page
Connection to Oil-Immersed Transformers	38
Connection to Dry-Type Transformers	40
Connection to Trihal Dry-Type Transformers	42

Connection to Oil-Immersed Transformers

Introduction

The Canalis KT system can be connected to oil-immersed transformers using either a vertical incomer arrangement or a horizontal incomer arrangement.

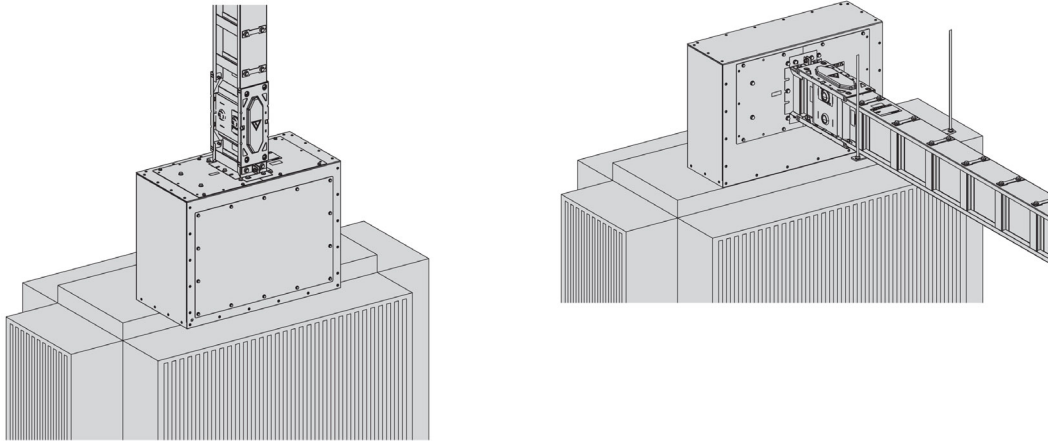

A KTB••••CR• protective cover must be installed on the transformer. If the transformer is delivered with a cable box, the cable box must be removed before the installation of the protective cover.

Procedure

The procedure for connecting oil-immersed transformers is described in instruction sheets available on the Schneider Electric website:

- For connecting Canalis KTA1000-4000/KTC1350-5000 to oil-immersed transformers: [AAV17625](#).
- For Canalis KTA1000-4000/KTC1350-5000 vertical incomer arrangement: [PHA12477](#).
- For Canalis KTA1000-4000/KTC1350-5000 horizontal incomer arrangement: [PHA12478](#).
- For Canalis KTA5000/KTC6300 horizontal incomer arrangement: [PHA44577](#).
- For Canalis KTA5000/KTC6300 vertical incomer arrangement: [PHA44578](#).

Step	Action
1	Remove the cable box if the transformer is equipped with a cable box.
2	Install the KTB••••CR• protective cover on the transformer.
3	Install the end feed unit with its supports.
4	Check that the weight of the run components does not rest on the transformer (<i>see page 22</i>).
5	Check the phase order of the run components in the installation, the end feed units, and the transformer (<i>see page 15</i>).
6	Open the protective cover.
7	Attach the end feed unit to the protective cover on the transformer.
8	If the protective earth conductor (PE) must be connected to neutral conductor (N) to create a PEN, use the PEN link delivered with the end feed unit (<i>see page 39</i>).
9	Determine the number of flexible links according to the rating (<i>see page 39</i>).
10	Connect the flexible links to the end feed unit and tighten the bolts to a torque of 60 N•m.
11	Attach the flexible links to the transformer bars using one of the following methods: <ul style="list-style-type: none"> ● With KTB0000YS• bar clamps, tightened to a torque of 100 N•m. ● With bolts, tightened to the torque recommended by the manufacturer of the bolts.
12	Check for correct clearances between the flexible links, and between the bar clamps and the base of the transformer bars.
13	Close the protective cover of the transformer.

PEN Connection

To connect the protective earth conductor (PE) to the neutral conductor (N) to create a PEN, use the PEN link delivered with the end feed unit:

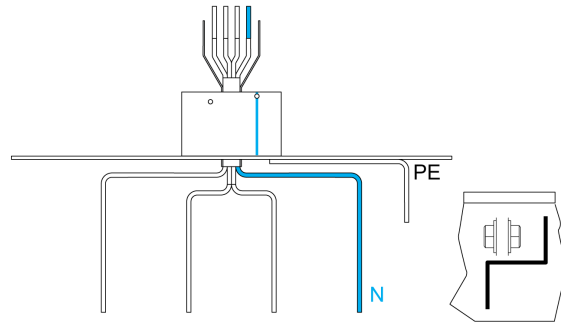

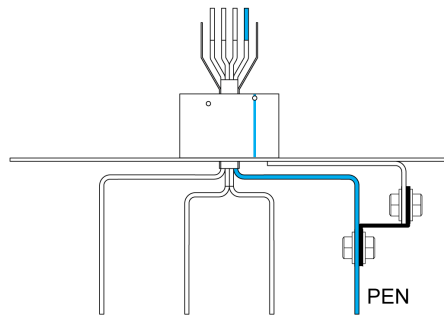

Connect the PEN link between the protective earth conductor (PE) and the neutral conductor (N) of the end feed unit by using the bolts delivered with the link.

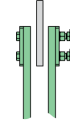
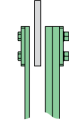
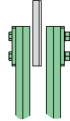
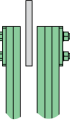
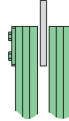
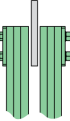

Flexible Links

The number of flexible links required for the connection of the transformer to the end feed unit depends on the rating of the busbar trunking system.

KTA rating (A)	1000 to 1600	2000 to 2500	3200	4000	–	5000	–
KTC rating (A)	1350 to 1600	2000 to 2500	3200	4000	5000	–	6300
Number of flexible links	 1 1	 1 2	 2 2	 2 3	 3 3	 3 3	 4 4
Copper Bars	2 (100×5)	3 (100×5)	4 (100×5)	5 (100×5)	6 (100×5)	6 (120×5)	8 (120×5)
Cross section (mm ²)	1000	1500	2000	2500	3000	3600	4800

Connection to Dry-Type Transformers

Introduction

The Canalis KT system can be connected to dry-type transformers using either an edgewise or a flatwise arrangement. The incoming run component can either be from the side or the centre.

Examples of connection arrangements:

Edgewise with side in comer:

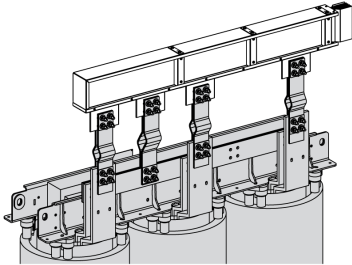

Flatwise with side in comer:

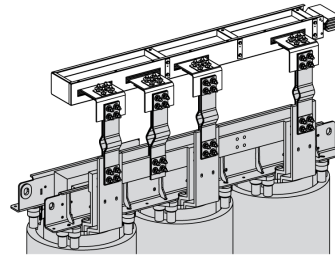

Edgewise with centre in comer:

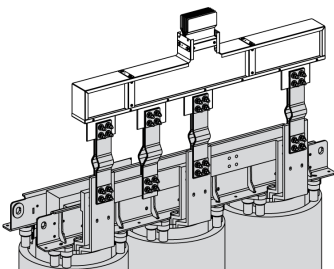

Flatwise with centre in comer:

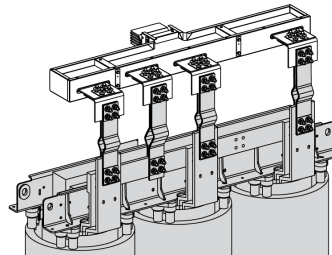

Flatwise with side in comer for Canalis KTA5000/KTC6300

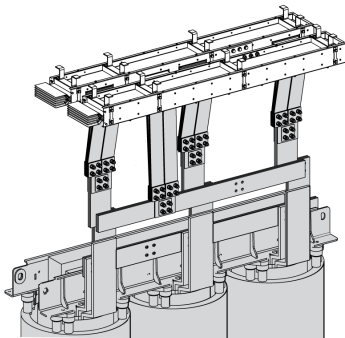

NOTE: Dry-type transformers can be connected to Canalis KTA5000 and KTC6300 only flatwise with side in comer arrangement or edgewise with center in comer arrangement.

Procedure

The procedure for connecting dry-type transformers is described in instruction sheets available on the Schneider Electric website:

- For connecting Canalis KTA1000-4000/KTC1350-5000 to dry-type transformers: [AAV32054](#).
- For connecting Canalis KTA5000/KTC6300 to dry-type transformers flatwise: [PHA44575](#).
- For connecting Canalis KTA5000/KTC6300 to dry-type transformers edgewise: [PHA44576](#).

Step	Action
1	Install the end feed unit with its supports (<i>see page 41</i>).
2	Check that the weight of the components does not rest on the transformer (<i>see page 22</i>).
3	Check the phase order of the run components in the installation, the end feed unit, and the transformer (<i>see page 15</i>).
4	For transformers installed in an enclosure, make a cut-out on the top plate of the enclosure for the installation of a KTB••••CR• protective cover.
5	If the installation is flatwise, attach the KTB••••YE• angle brackets on the end feed unit.
6	Check that the distance from the conductors of the end feed units to the transformer bars is correct.

Step	Action
7	Determine the number of flexible links according to the rating (<i>see page 41</i>).
8	Attach the flexible links to the end feed unit and tighten the bolts to a torque of 60 N•m.
9	Attach the flexible links to the transformer with bolts and tighten the bolts to the torque recommended for the bolts used.
10	Check for correct clearances between the flexible links and between the bar clamps and the base of the transformer bar.
11	If the transformer is installed in an enclosure, install the KTB••••CR• protective cover in the cut-out made on the top plate of the enclosure.

Support of the End Feed Unit

Take note of the following points:

- If the end feed unit is installed in edgewise position, use KTB••••ZA4 supports (rods not provided). Consult the instruction sheet [AAV32042](#) available on the Schneider Electric website.

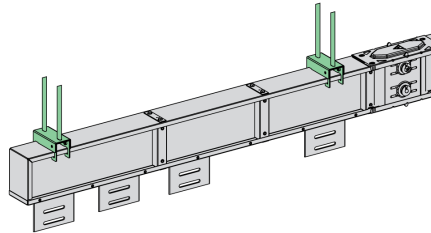

- If the end feed unit is installed in flatwise position, use the KTB••••YE• brackets provided to attach M10 rods to the end feed unit (rods not provided).

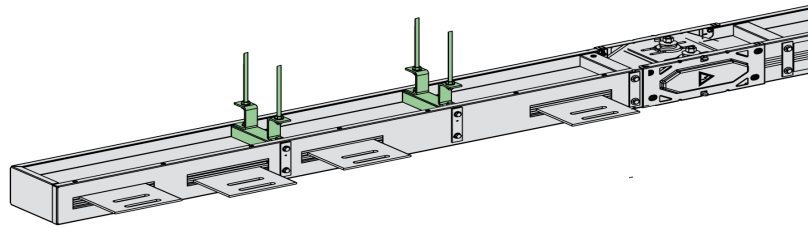

Flexible Links

The number of flexible links required for the connection of the transformer to the end feed unit depends on the rating of the busbar trunking system.

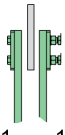
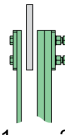
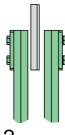
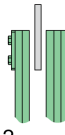
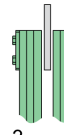
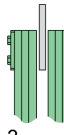
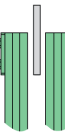
KTA rating (A)	1000 to 1600	2000 to 2500	3200	4000	–	5000	–
KTC rating (A)	1350 to 1600	2000 to 2500	3200	4000	5000	–	6300
Number of flexible links	 1	 2	 2	 3	 3	 3	 2x3
Copper Bars	2 (100×5)	3 (100×5)	4 (100×5)	5 (100×5)	6 (100×5)	6 (120×5)	12 (100×5) ⁽¹⁾
Cross section (mm ²)	1000	1500	2000	2500	3000	3600	6000
(1) Use only KTB0100YC5••••• insulated flexible links.							

Connection to Trihal Dry-Type Transformers

Introduction

The Trihal dry-type transformer can be equipped with a Canalis interface that enables a direct connection to the run components.

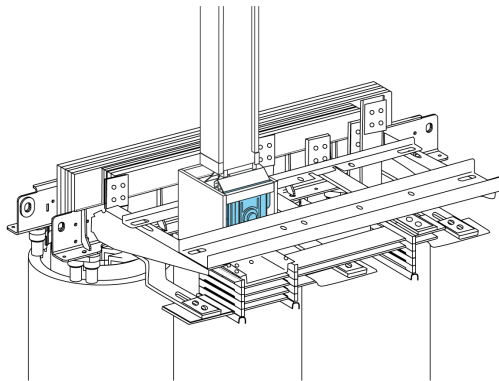

Procedure

The procedure for connecting a Trihal dry-type transformer is described on the transformer.

Step	Action
1	Check the supports and the run components. Verify that the weight of the components does not rest on the transformer (<i>see page 22</i>).
2	Check the phase order and the neutral position between the run components and the transformer (<i>see page 15</i>).
3	Cut out the top plate to prepare the installation of a KTB•••TT01 sealing kit if the transformer is installed in an enclosure (<i>see page 42</i>).
4	Connect the run component to the Canalis interface. Run components of different heights can be used for one Trihal transformer rating (<i>see page 43</i>).
5	Tighten the bolts in the Canalis interface to a torque of 60 N•m. NOTE: On Canalis interfaces of height 324 mm and 404 mm, there are four tightening bolts available. When connected to Canalis run components of height 164, 204 or 244 mm, the two external bolts need to be tightened to a torque of 10 N•m. In these cases the nut head remains on the bolt and the red washers must be removed manually.
6	Close the transformer with the sealing kit if the transformer is installed in an enclosure (<i>see page 42</i>).

Sealing Kit for Transformers in an Enclosure

The top plate of the Trihal dry-type transformer in an enclosure must be cut out to enable the installation of a KTB•••TT01 sealing kit. The sealing kit includes a drilling and cut out template, illustrated here:

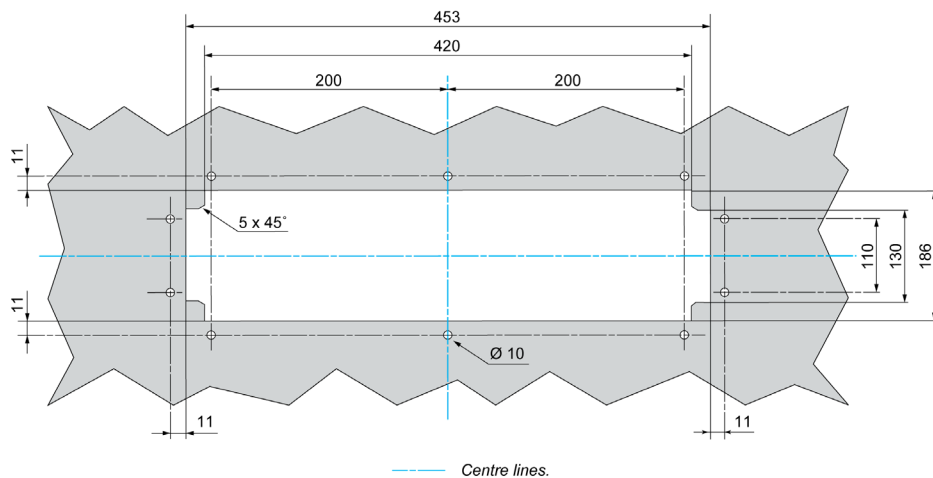

The procedure for installing the sealing kit is described in the instruction sheet [AAV32049](#) available on the Schneider Electric website.

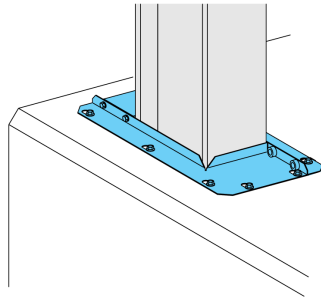

Connecting the Canalis Interface

The height of the Canalis interface is defined by the rating of the Trihal transformer.

The following graphic shows how the heights of the Canalis interface (J) and the run components (K) are defined.

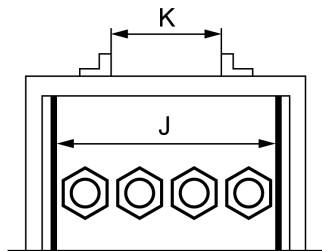

The following table gives the heights of the run components that can be connected to a Canalis interface of a given height:

Height of Canalis interface (J) (mm)	Height of run component (K) (mm)
124	74, 104, 124
164	104, 124, 164
204	204
244	204, 244
324	244, 324
404	324, 404

Chapter 4

Switchboard Connections

What Is in This Chapter?

This chapter contains the following topics:

Topic	Page
Connection to Switchboards	46
Connection to Prisma P and Okken Switchboards	49

Connection to Switchboards

Introduction

The Canalis KT system can be connected to switchboards in the following ways:

- Directly to the connection bars.
- Using flexible links or connection bars, with a KTB••••CR• protective cover:
 - In a vertical arrangement.
 - In a horizontal arrangement.

Examples of connection arrangements:

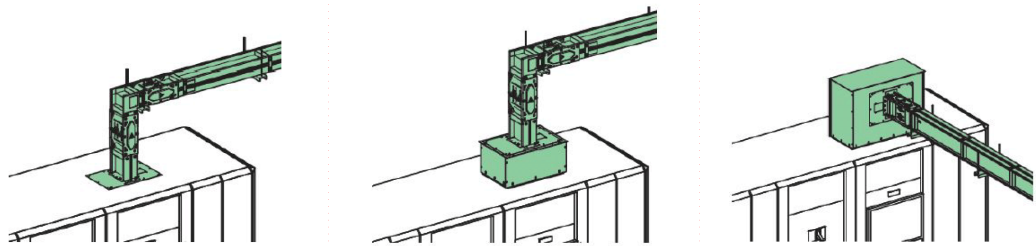

Procedure for Direct Connection

The procedure for direct connection to switchboards is described in instruction sheets available on the Schneider Electric website:

- For connecting Canalis KTA1000-4000/KTC1350-5000 to switchboard: [AAV17625](#).
- For Canalis KTA5000/KTC6300 horizontal incomer arrangement: [PHA44577](#).
- For Canalis KTA5000/KTC6300 vertical incomer arrangement: [PHA44578](#).

Step	Action
1	Check that the weight of the components does not rest on the switchboard. (see page 22)
2	Check the phase order of the components in the installation, the end feed unit, and the switchboard (see page 15).
3	If the protective earth conductor (PE) must be connected to neutral conductor (N) to create a PEN, use the PEN link delivered with the end feed unit (see page 47).
4	Cut out the top plate of the switchboard to enable the installation of the end feed unit flange.
5	Attach the end feed unit to the switchboard.
6	Determine the number of connection bars according to the rating (see page 47).
7	Connect the end feed unit to the connection bars with bolts and tighten the bolts to a torque of 60 N•m.
8	Check that the enclosure of the end feed unit (PE or PER) is correctly connected to the earth of the switchboard.
9	Attach KTB0000YS1 bar supports on the flexible links or connection bars. The number of KTB0000YS1 bar supports to be used depends on the length of the flexible links or connection bars. The distance between the KTB0000YS1 bar supports depends on the rated short-time withstand current I _{cw} of the equipment (see page 48).
10	Check for proper clearances between the active conductors and the switchboard.

Procedure for Connection Using a Protective Cover

The procedure for connection to switchboards using a KTB••••CR• protective cover is described in the instruction sheet [AAV17625](#), available on the Schneider Electric website.

Step	Action
1	Check that the weight of the components does not rest on the switchboard (see page 22).
2	Check the phase order of the components in the installation, the end feed unit, and the switchboard (see page 15).
3	If the protective earth conductor (PE) must be connected to neutral conductor (N) to create a PEN, use the PEN link delivered with the end feed unit (see page 47).
4	Cut out the top plate of the switchboard to enable the installation of the protective cover.
5	Install the protective cover on the switchboard.

Step	Action
6	Attach the end feed unit to the protective cover on the switchboard.
7	Open one panel of the protective cover.
8	Determine the number of flexible links or connection bars, according to the rating (<i>see page 47</i>).
9	Attach the flexible links or connection bars to the end feed unit and tighten the bolts to a torque of 60 N•m.
10	Attach the flexible links or connection bars to the switchboard bars with bolts and tighten the bolts to the torque recommended by the bolt manufacturer.
11	Attach KTB0000YS1 bar supports on the flexible links or connection bars. The number of KTB0000YS1 bar supports to be used depends on the length of the flexible links or connection bars. The distance between the KTB0000YS1 bar supports depends on the rated short-time withstand current I_{cw} of the equipment (<i>see page 48</i>).
12	Check for proper clearances between the active conductors and the switchboard.
13	Close the protective cover.

PEN Connection

To connect the protective earth conductor (PE) to the neutral conductor (N) to create a PEN, use the PEN link delivered with the end feed unit:

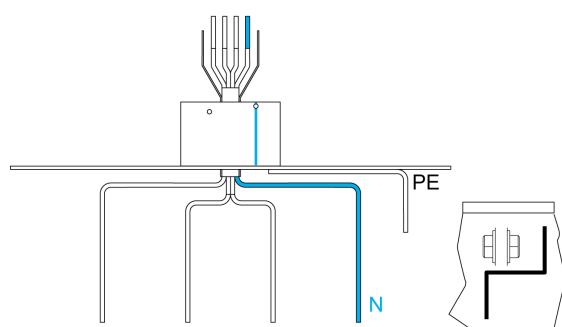

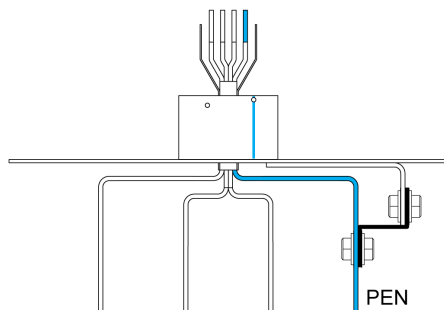

Connect the PEN link between the protective earth conductor (PE) and the neutral conductor (N) of the end feed unit by using the bolts delivered with the link.

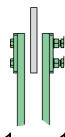
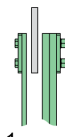
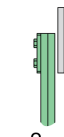
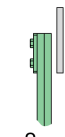

Flexible Links

The number of flexible links or connection bars required for the connection of the switchboard to the end feed unit depends on the rating of the busbar trunking system.

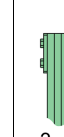
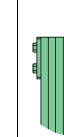
KTA rating (A)	1000 to 1600	2000 to 2500	3200	4000	–	5000	–
KTC rating (A)	1350 to 1600	2000 to 2500	3200	4000	5000	–	6300
Number of flexible links	 1	 2	 2	 3	 3	 3	 4
Copper Bars	2 (100×5)	3 (100×5)	4 (100×5)	5 (100×5)	6 (100×5)	6 (120×5)	8 (120×5)
Cross section (mm ²)	1000	1500	2000	2500	3000	3600	4800

Distance Between Supports According to I_{cw}

KTB0000YS1 bar supports must be used to support the flexible links or connection bars. The number of bar supports depends on the length of the flexible links or connection bars and the value of I_{cw} .

The following table shows the maximum distance between two supports, depending on the I_{cw} , and allows you to calculate the number of supports needed for the length of flexible links or connection bars used:

Rated short-time withstand current I_{cw}	Maximum distance x between 2 supports
$I_{cw} \leq 43 \text{ kA}$	400 mm
$43 \text{ kA} < I_{cw} \leq 50 \text{ kA}$	225 mm
$50 \text{ kA} < I_{cw} \leq 100 \text{ kA}$	150 mm

Bar supports are installed as shown:

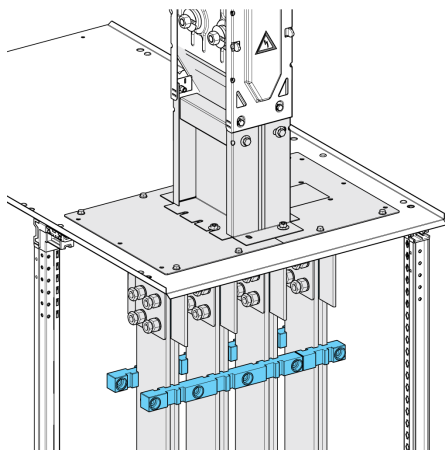

Maximum distance between bars supports (x):

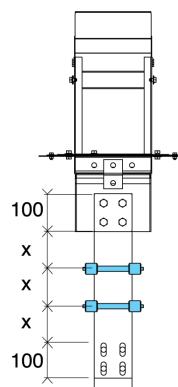

Connection to Prisma P and Okken Switchboards

Introduction

The Prisma P and Okken switchboards can be equipped with a Canalis interface that enables a direct connection between the main circuit breaker installed in the switchboard and the run components of the Canalis KT system.

Prisma P switchboard

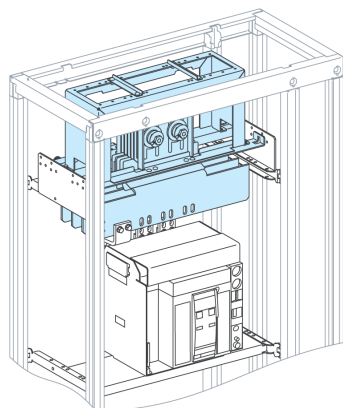

Okken switchboard

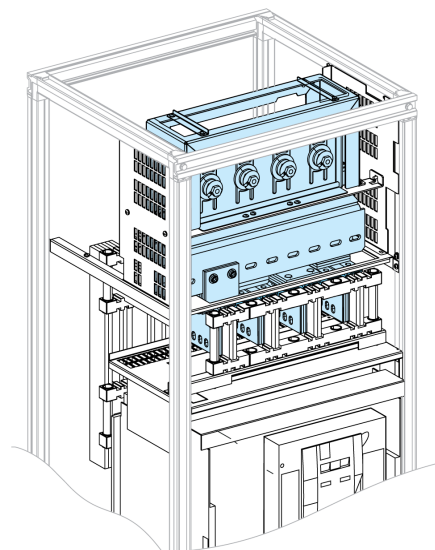

Procedure

Step	Action
1	Check that the weight of the run components do not rest on the switchboard (<i>see page 22</i>).
2	Check the installation of the Canalis interface in the switchboard (<i>see page 51</i>).
3	Check the phase order and the position of the neutral between the run component and the Canalis interface (<i>see page 15</i>).
4	If the run component is equipped with a reinforced protective earth conductor (PER), install a KTB•••PE1 reinforced protective earth conductor to the Canalis interface (<i>see page 50</i>).
5	Cut out the top plate of the switchboard to prepare the installation of a KTB•••TT01 sealing kit (<i>see page 50</i>).
6	Adapt the position of the guides on the Canalis interface to the rating of the run component (<i>see page 51</i>).
7	Connect the run component to the Canalis interface. Tighten the bolts in the Canalis interface to the torque of 60 N•m. NOTE: On Canalis interfaces of height 404 mm, there are four tightening bolts available. When connected to a Canalis run component of height 204 mm, the two external bolts need to be tightened to a torque of 10 N•m. In this case the nut head remains on the bolt and the red washers must be removed manually.
8	Attach the sealing kit on the switchboard (<i>see page 50</i>).

Checking the Canalis Interface in the Switchboard

To check the correct installation of the Canalis interface in the switchboard, consult the following instruction sheets available on the Schneider Electric website:

- For Canalis interface for Masterpact NT and Compact NS in Prisma P switchboard: [04696147](#).
- For Canalis interface for Masterpact NW 800 to 3200 A in Prisma P switchboard: [04696148](#).
- For Canalis interface for Masterpact NW 4000 A in Prisma P switchboard: [04696291](#).

Installing a Reinforced Protective Earth (PER) Conductor

The procedure for adding the PER to the Canalis interface is described in the instruction sheet [S1A32783](#) available on the Schneider Electric website.

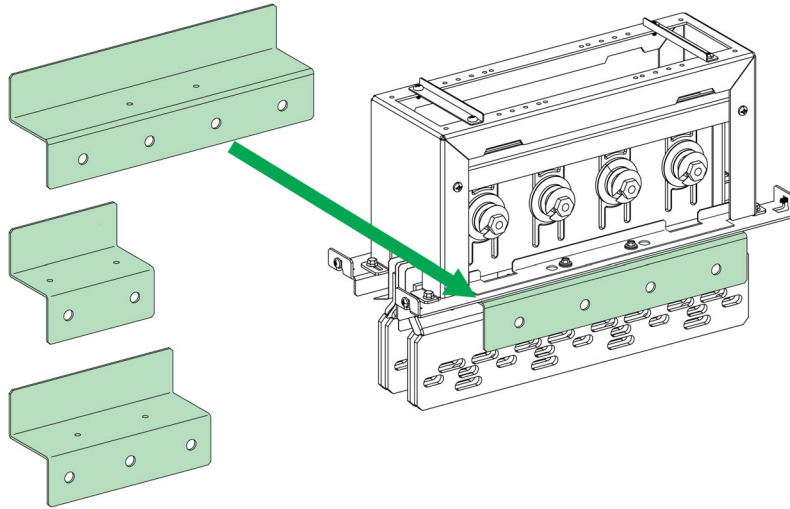

Sealing Kit

The top plate of the switchboard must be cut out to enable the installation of a KTB•••TT01 sealing kit. The sealing kit includes a drilling and cut out template, illustrated here:

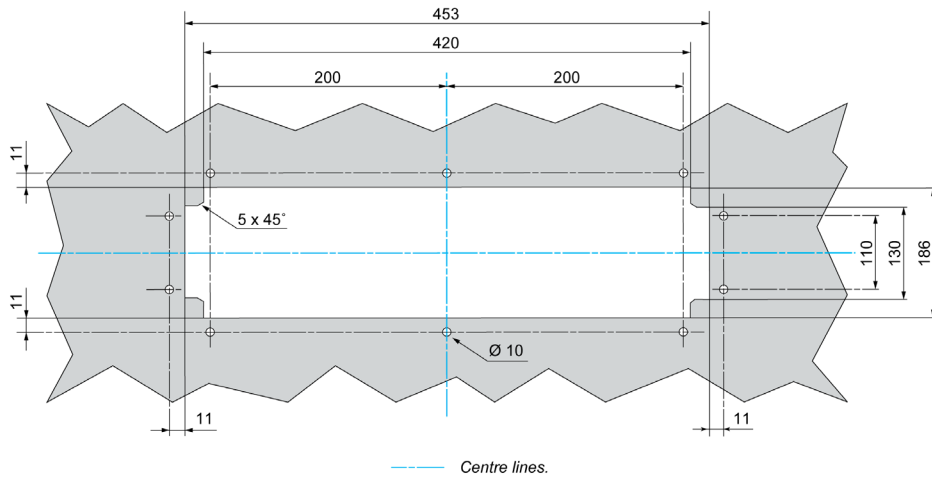

The procedure for installing the sealing kit is described in the instruction sheet [AAV32049](#), available on the Schneider Electric website.

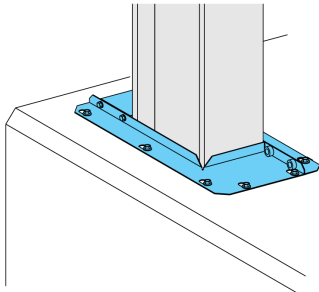

Adapting the Canalis Interface

The size of the Canalis interface is defined by the type of the main circuit breaker installed in the switchboard.

The following graphic shows how the heights of the Canalis interface (J) and the run components (K) are defined:

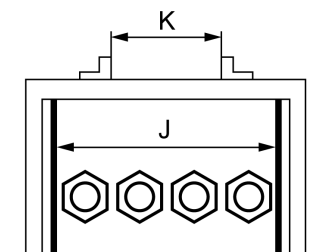

The following table gives the heights of the run components that can be connected to a Canalis interface of a given height:

Height of the Canalis interface (J) (mm)	Height of the run component (K) (mm)
164	74, 104, 124, 164
244	164, 204, 244
404	244, 324, 404

The position of the guides on the Canalis interface must be adapted to the rating of the run component.

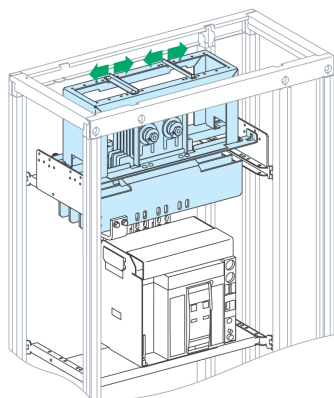

Chapter 5

Installation of Tap-Off Units

What Is in This Chapter?

This chapter contains the following topics:

Topic	Page
Installation of Plug-In Tap-Off Units	54
Installation of Bolted Tap-Off Units	58

Installation of Plug-In Tap-Off Units

Introduction

Tap-off units are used to connect loads or secondary runs. They comply with installation standards and regulations (IEC 60364) irrespective of the earthing system (TT, TNS, TNC, or IT).

The plug-in tap-off units can be operated and plugged in or unplugged when the Canalis KT system is live. Plugging in and unplugging a tap-off unit automatically opens and closes the tap-off point.

⚡ ⚠ DANGER

HAZARD OF ELECTRIC SHOCK, EXPLOSION OR ARC FLASH

- Beware of potential hazards.
- Do not open or close the cover of a tap-off unit with the downstream load energized.
- Carefully inspect the work area for tools and objects that may have been left inside the tap-off unit.

Failure to follow these instructions will result in death or serious injury.

Types of Plug-In Tap-Off Units

There are two types of plug-in tap-off units:

- Plug-in tap-off units without automatic clamping system.

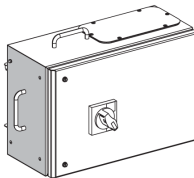

- Plug-in tap-off units with automatic clamping system.

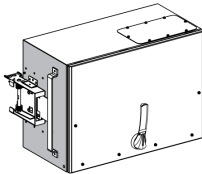

The plug-in tap-off units from the Canalis KS system are compatible with the Canalis KT system.

Procedure for Installing Plug-In Tap-Off Units Without Automatic Clamping System

The procedure for installing plug-in tap-off units without automatic clamping system is described in instruction sheets available on the Schneider Electric website. The list of instruction sheets can be found in the following table:

Device installed in plug in-tap-off unit without automatic clamping system	Tap-off unit rating	Catalogue number	Instruction sheet
Compact NSX circuit breaker	160 A	KSB160DC•••	AAV16555
	250 A	KSB250DC•••	AAV16555
	400 A	KSB400DC•••	AAV16555
Isolator for blade-type fuses	160 A	KSB160SE•	AAV16543
	250 A	KSB250SE•	AAV16546
	400 A	KSB400SE•	AAV16546

Follow this procedure to install plug-in tap-off units without automatic clamping system:

Step	Action
1	Open or remove the tap-off unit cover.
2	Install the protection device in the tap-off unit.
3	Remove the IP protection on the outlet of the run component.
4	Prepare the output cable glands and connect the cables to the tap-off unit.
5	Check that the protection device is switched off and carefully inspect the tap-off unit for tools and objects that may have been left inside the tap-off unit.

Step	Action
6	Position the rear of the tap-off unit on the run component.
7	Plug the tap-off unit into the run component.
8	Lock the tap-off unit on the run component using the locking handle located inside the tap-off unit (<i>see page 56</i>).
9	Secure the tap-off unit on the run component using the fixing mechanism.
10	Close the tap-off unit cover. The system and the load are ready to be energized.

Procedure for Installing Plug-In Tap-Off Units With Automatic Clamping System

The procedure for installing plug-in tap-off units with automatic clamping system is described in instruction sheets available on the Schneider Electric website. The list of instruction sheets can be found in the following table:

Device installed in plug in-tap-off unit with automatic clamping system	Tap-off unit rating	Catalogue number	Instruction sheet
Compact NSX circuit breaker	630 A	KTB0630DC•	NVE44417
Isolator for blade-type fuses	630 A	KTB0630SD•	NVE48158
Isolator for blade-type fuses, internal arc tested	630 A	KTB0630SE•	NVE47487

The list of instruction sheets for the accessories can be found in the following table:

Accessories	Catalogue number	Instruction sheet
Kit of connection bars for KTB0630DC•	KTB0630ZA01	NVE46045
Kit of connection bars for KTB0630SD•	KTB0630ZA02	NVE46746
Extension rotary handle for KTB0630SD• and KTB0630SE•	KTB0630ZA03	NVE49438

Follow this procedure to install plug-in tap-off units with automatic clamping system:

Step	Action
1	Install the automatic clamping system and the rear pivots delivered with the tap-off unit on the run component.
2	Open or remove the tap-off unit cover.
3	Install the protection device in the tap-off unit. NOTE: In tap-off units with PEN, you can remove the connection between the neutral and earth if needed.
4	Remove the IP protection on the outlet of the run component.
5	Prepare the output cable glands and connect the cables to the tap-off unit.
6	Check that the protection device is switched off and carefully inspect the tap-off unit for tools and objects that may have been left inside the tap-off unit.
7	Place the tap-off unit on the rear pivots and click it into the disconnected position on the clamping system. (<i>see page 56</i>)
8	Unlock the clamping system by pulling the attached flap and push the tap-off unit in the run component. The tap-off unit is in the connected position (<i>see page 57</i>).
9	Secure the tap-off unit onto the run component using bolts.
10	Lock the tap-off unit on the run component using the locking handle located inside the tap-off unit (<i>see page 56</i>).
11	Close the tap-off unit cover. The system and the load are ready to be energized.

Locking the Tap-Off Unit on the Run Component

A handle located inside the plug-in tap-off unit enables the tap-off unit to be mechanically locked onto the run component.

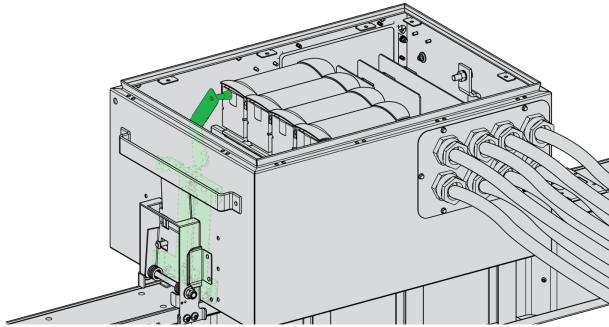

The locking handle is only accessible when the door of the tap-off unit is open. The door of the tap-off unit can only be opened when the protection device is off (no load). In this way, the tap-off unit cannot be removed from the run component when the load is on.

Installing the Tap-Off Unit With Automatic Clamping System on the Run Component

The tap-off unit with automatic clamping system is installed on the run component by placing the notches onto the rear pivots and rotating the tap-off unit down onto the run component. The tap-off unit clicks into the disconnected position:

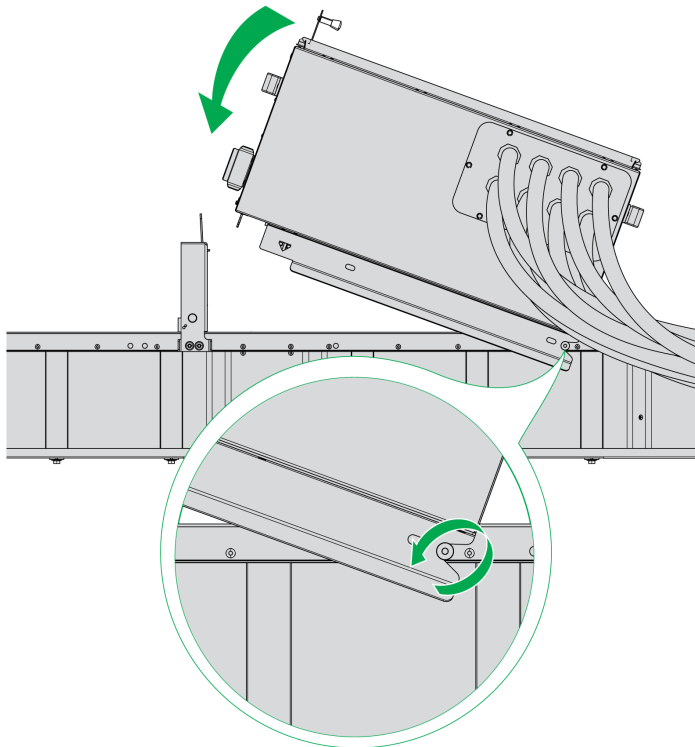

Positions of the Tap-Off Unit With Automatic Clamping System

The tap-off unit with automatic clamping system can be clamped in two stable positions:

- Disconnected position: the tap-off unit is not connected to the mains. It can remain clamped in this disconnected position before being plugged into the run component.

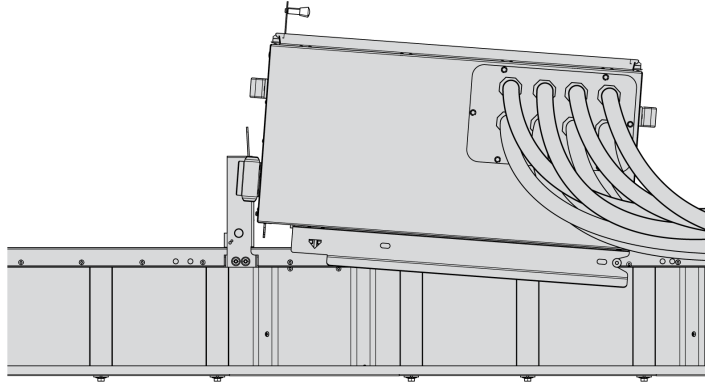

- Connected position: the tap-off unit is connected to the mains.

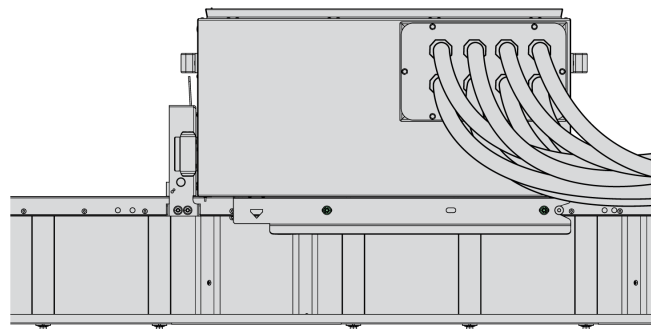

Installation of Bolted Tap-Off Units

Introduction

Tap-off units are used to connect loads or secondary runs. They comply with installation standards and regulations (IEC 60364) irrespective of the earthing system (TT, TNS, TNC, or IT).

Bolted tap-off units can be plugged into and removed from the run component when the run component is not energized.

The bolted tap-off units from the Canalis KS systems are compatible for use with the Canalis KT system.

 **DANGER**

HAZARD OF ELECTRIC SHOCK, EXPLOSION OR ARC FLASH

- Beware of potential hazards.
- Do not install a bolted tap-off unit on energized run components.
- Always use a properly rated voltage sensing device to confirm power is off.
- Do not open or close the cover of a tap-off unit with the downstream load energized.
- Carefully inspect the work area for tools and objects that may have been left inside the tap-off unit.

Failure to follow these instructions will result in death or serious injury.

Procedure

The procedure for installing bolted tap-off units is described in instruction sheets available on the Schneider Electric website. The list of instruction sheets can be found in the following table:

Device installed in bolted tap-off unit	Tap-off unit rating	Catalogue number	Instruction sheet
Compact NSX circuit breaker	630 A	KTB0630CB•	AAV32052
	1000 A	KTB1000CB•	AAV32052
	1250 A	KTB1250CB•	BBV39803
Isolator for blade-type fuses	630 A	KTB0630HF•	AAV82964
	1000 A	KTB1000HF•	AAV82964

Follow this procedure for installing bolted tap-off units:

Step	Action
1	Remove the tap-off unit cover.
2	Install the protection device in the tap-off unit. NOTE: In tap-off units with PEN, you can remove the connection between the neutral and earth if needed.
3	Check that the protection device is switched off and carefully inspect the tap-off unit for tools and objects that may have been left inside the tap-off unit.
4	Check that the run component is not energized. Always use a properly rated voltage sensing device to confirm that the power is off.
5	Remove the IP protection on the outlet of the run component.
6	Plug the tap-off unit into the run component.
7	Screw the tap-off unit onto the run component.
8	Slide the bolt access shutter on the tap-off unit to align the holes and provide access to the connection bolt.
9	Tighten the connection bolt of the tap-off unit to a torque of 100 N•m to provide the electrical connection (<i>see page 59</i>).
10	Slide back the bolt access shutter to prevent access to the connection bolt.
11	Prepare the output cable glands and connect the cables to the tap-off unit.
12	Close the tap-off unit cover. The system and load are ready to be energised.

Rules for Tightening the Connection Bolt of the Tap-Off Unit

Correct tightening of the bolts of the tap-off unit enables the electrical connection. Follow these rules when tightening the bolts:

- The connection bolt must be tightened to a torque of 100 N•m, using the appropriate torque wrench.

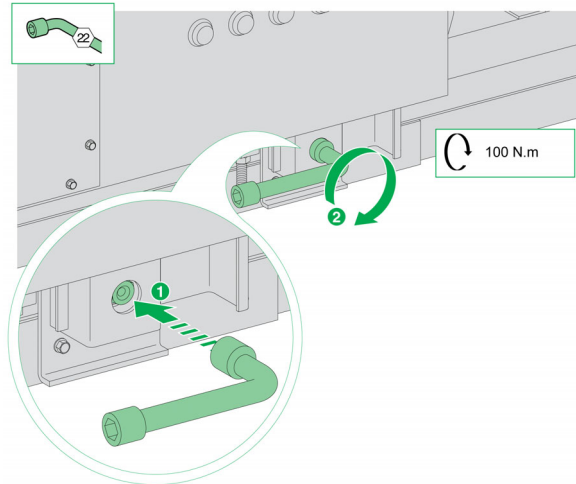

- When the correct tightening torque is reached, the nut head snaps off, freeing a red washer (shear nuts). The freed red washer falls off.

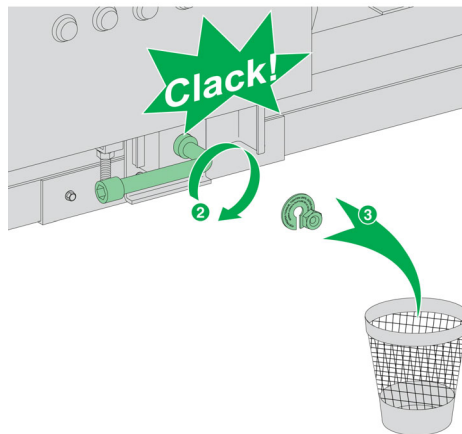

- The tightening has been done correctly only if the red washer is absent after the procedure.
- For dismantling or maintenance operations, the nut has a second head.
If the bolted tap-off unit is dismantled and reassembled at installation or for maintenance, the torque of 100 N•m must be checked with a torque wrench.

Chapter 6

Installation of Specific Components

What Is in This Chapter?

This chapter contains the following topics:

Topic	Page
Installation of Expansion Units	62
Installation of Fire-Barrier Kit	65

Installation of Expansion Units

Introduction

The expansion unit controls and absorbs the expansion of run components. Expansion units have the following features:

- The expansion unit is 1 m in length and must be fitted horizontally.
- The expansion unit is equipped with flexible conductor joints and a sliding case at its centre. These absorb the relative movements of the section that the expansion unit is installed in.

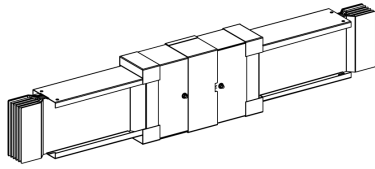

Expansion units must be used in the following cases:

- The run is made up of straight sections longer than 30 m: the expansion unit absorbs length variations of the run components occurring due to changes in temperature.
- The run passes through an expansion joint between two buildings: the expansion unit absorbs the forces due to the movement of the two buildings relative to each other.

Procedure

The procedure for installing expansion units is the same as the procedure for installing run components on horizontal supports (*see page 27*). The procedure is described in the instruction sheet [AAV32038](#) available on the Schneider Electric website.

Expansion Units on Long Runs

If the run length is greater than 30 m, you must provide for expansion units and appropriate means of anchoring.

The ends and, in some cases, the centre of straight sections must be anchored in order to direct the expansion towards the expansion units. This implies that:

- A straight section containing an expansion unit must be free from all longitudinal movement on its supports.
- The straight section must be rigidly anchored at the ends that are not joined to the expansion unit.
- If more than one expansion unit is installed on a straight section, the section must be rigidly anchored between the expansion units.

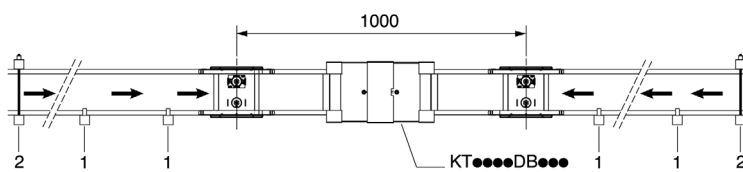

- 1 Free supports
- 2 Anchored supports
- ← Direction of expansion

Number of Expansion Units According to the Run Length

Expansion units on horizontal runs without tap-off units

Run length	Number of expansion units	Configuration
0 to 30 m	0	
31 to 60 m	1	
61 to 90 m	2	
91 to 120 m	3	
<p> Anchor point Expansion unit Direction of expansion </p>		

Expansion units on horizontal runs with tap-off units:

Run length	Number of expansion units	Configuration
0 to 30 m	0	
31 to 60 m	1	
61 to 120 m	2	
<p> Anchor point Expansion unit Direction of expansion Tap-off unit </p>		

Expansion Units on Transformer and Switchboard Links

In transformer or switchboard links, provide a rigid anchor just before the run component that is connected to the end feed units. Provide for expansion units every 30 m of straight run length (L).

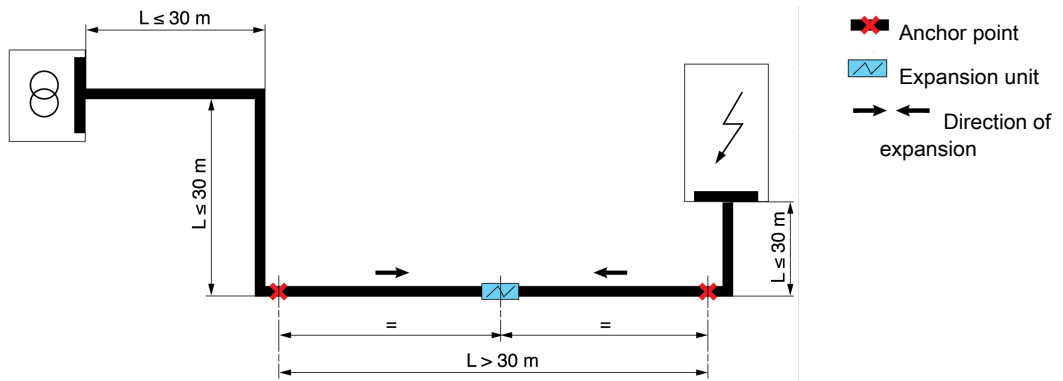

Expansion Units Between Two Buildings

The expansion unit installed between two buildings is used to absorb the forces arising due to the movement of the two buildings relative to each other.

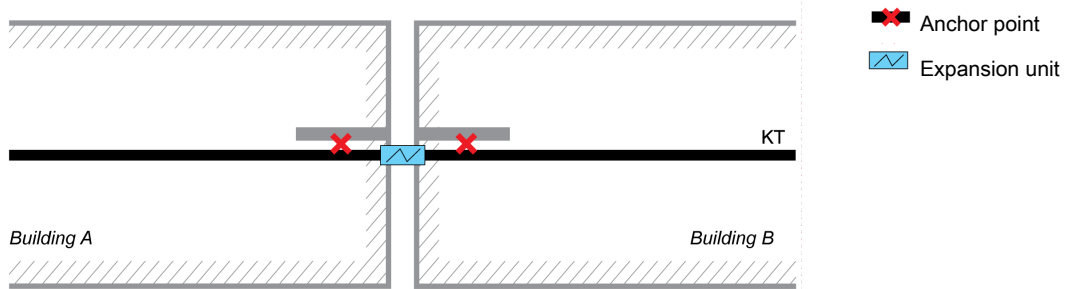

Anchoring the Run Components

The run components can be anchored to the supports using accessories as shown:

Edgewise assembly:

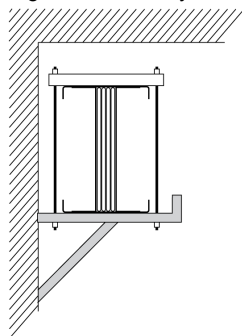

Flatwise assembly:

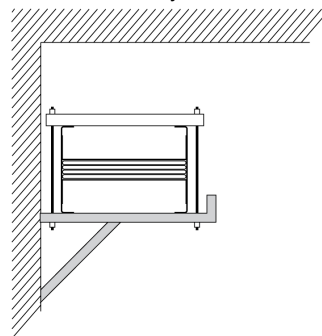

NOTE: Accessories to anchor the run components on the supports are not provided by Schneider Electric.

Installation of Fire-Barrier Kit

Introduction

Where Canalis KT system passes through a partition wall or a floor slab, it inherently acts as a fire barrier for up to 30 minutes. For greater protection levels of up to 120 minutes, a fire-barrier kit must be installed.

CAUTION

HAZARD OF IRRITATION

Wear suitable personal protective equipment, including gloves, goggles, and a protective mask while installing the fire-barrier kit.

Failure to follow these instructions can result in injury or equipment damage.

Procedure

The procedure for installing the fire-barrier kit is described in the instruction sheet [S1A68982](#), available on the Schneider Electric website.

Step	Action
1	Check the dimensions of the hole through the partition wall or floor slab.
2	Define the position of the fire-barrier kit on the run component. The fire-barrier kit must be positioned more than 200 mm from any joint block (<i>see page 66</i>).
3	Install the fire-barrier kit around the run component. If the fire-barrier kit is installed around a run component with lateral reinforcement, then the components of the fire-barrier kit must be cut accordingly.
4	After installing the fire-barrier kit, use mortar or fire-resistant plaster to fill the gaps between its component parts. The material used to fill the gaps must meet the applicable requirements in force (for example, DIN 1045 and DIN 1053-1) to maintain the fire-resistance rating of the partition wall or floor slab.
5	Install the run component with the fire-barrier kit on supports, through the partition wall or floor slab. Do not place any support directly under the fire-barrier kit.
6	Install the KTA5000 and KTC6300 run components with two fire barrier kits, one for each run component (<i>see page 66</i>).
7	After installing the run component, use mortar or fire-resistant plaster to fill the hole around and outside the fire-barrier kit. The material used to fill the hole must meet the applicable requirements in force (for example, DIN 1045 and DIN 1053-1) to maintain the fire-resistance rating of the partition wall or floor slab.

Fire Barrier Position

Take note of the following points when installing the fire-barrier kit:

- The fire-barrier kit must be positioned more than 200 mm from any joint block.
- The position of the fire-barrier kit on a horizontal or vertical run component can be adjusted with respect to the partition wall or floor slab as indicated in the following graphic.

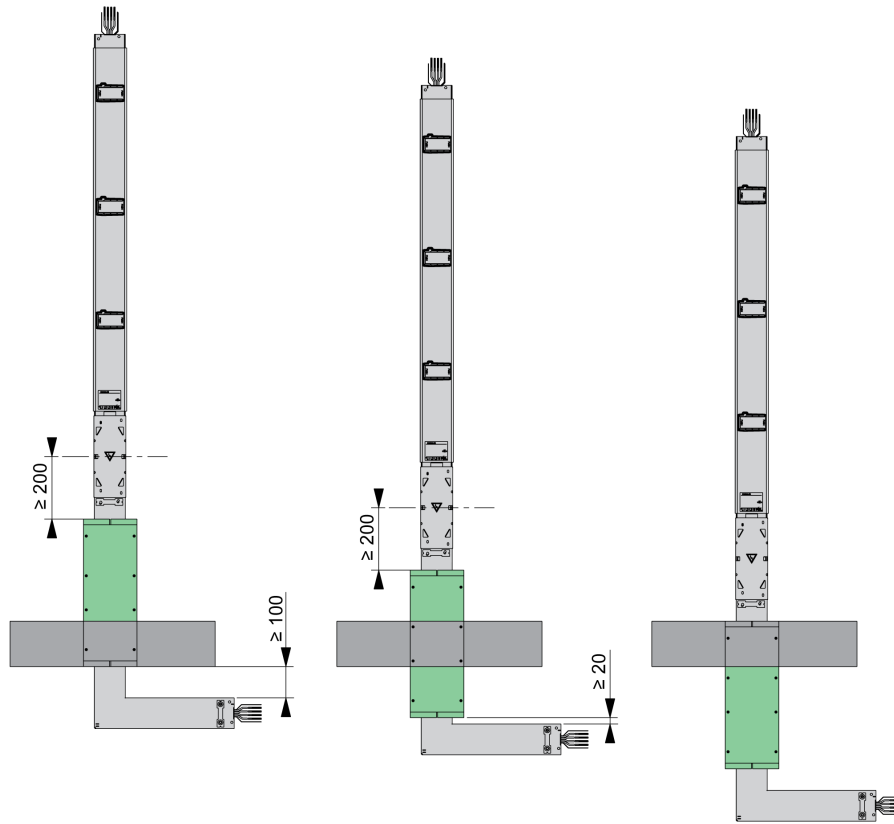

Installing KTA5000/KTC6300 Fire Barriers

As the Canalis KTA5000/KTC6300 are made of two run components, the fire barrier kits for Canalis KTA5000/KTC6300 are made of two fire barriers, one for each run component. The distance between both run components must be 130 mm. Both fire barriers must be installed side by side and sealed together with fire barrier sealant KTB0000SC1 supplied with the KTB0622CF• fire barrier kit.

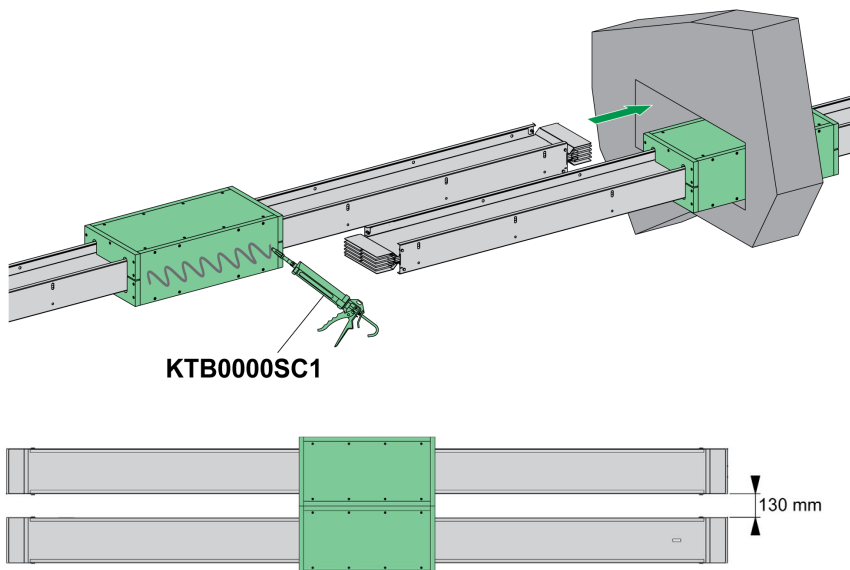

Chapter 7

Commissioning and Maintenance

What Is in This Chapter?

This chapter contains the following topics:

Topic	Page
Commissioning	68
Commissioning Check-list Before Energizing	71
Maintenance	73

Commissioning

Safety Instructions

⚠ DANGER

HAZARD OF ELECTRIC SHOCK, BURN, OR EXPLOSION

- Only qualified electrical maintenance personnel should install, operate, service or maintain this equipment.
- Perform such work only after reading and understanding all the instructions contained in the table below.
- Turn off all power supplying this equipment before working on or inside equipment.
- Always use a properly rated voltage sensing device to confirm power is off.
- Beware of potential hazards and take adequate safety precautions.

Failure to follow these instructions will result in death or serious injury.

Tests Before Energizing

Carry out the following tests before energizing the busbar trunking system. You can record the test results in the check-list provided (*see page 71*).

All the operations described below are given for indication only. Under no circumstances can they be used to substitute the installation company's own procedures and engage Schneider Electric's responsibility.

Step	Test	Description
1	Support and alignment check	A final check before energization is recommended to validate that all the installation rules are followed. Check for: <ul style="list-style-type: none"> ● the distance between the supports and their positions along the line. ● localization of the junctions. ● blocking points that can affect the expansion movements. ● the degree of IP protection rating must be checked.
2	Phase order and label check	Carry out a visual check of the phase order from end to end. Special attention is recommended if phase or neutral crossovers are installed. All labels have to be checked.
3	Connection check	<ul style="list-style-type: none"> ● Carry out a visual check on the tightening of the joint block bolts. All shear nuts should have the double-headed bolts snapped off and the red washers absent. If the joint block is dismantled and reassembled for any reason, the 60 N•m torque must be checked again with a torque wrench. ● Check the PE protective circuit equipotential (according to the standard IEC 61439-1). Using an ohmmeter, check the PE protective circuit continuity by visual inspection and random continuity testing. This test is carried out to detect the wrong mounting of the PE plate, for example, accidental insertion in the phase joint block.
4	Insulation check (before transformer and switchboard connections)	<ul style="list-style-type: none"> ● Measure the insulation resistance between each phase or neutral⁽¹⁾ and earth (if the casing is connected to earth). The insulation resistance has to be at minimum 1 MΩ according to the IEC 60364-6 and IEC 61.3.3 standards. NOTE: Use a megger rated at 500 Vdc if Ue ≤ 500 Vdc or 1000 Vdc if Ue > 1000 V (DC to avoid capacitive currents). ● Carry out a general visual inspection of the earth network. In particular check: <ul style="list-style-type: none"> ○ that the galvanized steel casing sides are earthed. This depends on the earthing system. ○ the connection quality. ○ the cable cross-section. ○ there are no loose metal parts (washers, screws) in the tap-off units.

(1) No neutral insulation check is required if the earthing system is such that the neutral is connected to or used as the earth.

Step	Test	Description
5	Transformer and switchboard connections check	<ul style="list-style-type: none"> ● Reconnect each link to the upstream transformer. ● Carry out a visual check on the tightening of the connection bolts at transformers and switchboards. The torque to apply depends on the screw size. Mark each tightened nut using indelible varnish. ● Carry out the insulation check between each phase or neutral⁽¹⁾ and earth, as described in step 4. NOTE: Once the transformer has been reconnected (star secondary), the phase-earth measurement is the winding resistance. ● Using a Roto-phase or 3-phase harmonic analyzer (CA8334 or Fluke 434), carry out a phase order check. This is to detect any inversion of the phases or neutral among the four incoming and outgoing connections of the busbar trunking system, with respect to the transformer output.
6	Protection settings check	<ul style="list-style-type: none"> ● Check that the upstream circuit breaker protection settings are in accordance with the installation drawing specifications and the protection plan of the busbar trunking system. ● Carry out compliance checks of the following, in accordance with the installation drawing specifications: <ul style="list-style-type: none"> ○ I_{max} thermal ○ I_n magnetic <p>NOTE: This check is to be performed only if the busbar trunking system is commissioned at the same time as the transformer. The upstream circuit breaker protection setting checks are related to transformer commissioning.</p> <p>NOTE: If this check is successful, the busbar trunking system can be commissioned and the energized operating tests performed with the appropriate protective equipment.</p>
7	Tap-off units check	<ul style="list-style-type: none"> ● Check that all the tap-off units are disconnected or isolated in off-load position. ● Check that the protective devices are correctly rated (current, breaking capacity) with respect to the loads supplied, or in accordance with the specification drawings.

(1) No neutral insulation check is required if the earthing system is such that the neutral is connected to or used as the earth.

Energizing the Equipment

 **DANGER**

HAZARD OF ELECTRIC SHOCK, BURN, OR EXPLOSION

Carry out the tests to detect any short circuit or earth fault caused by incorrect installation before energizing the busbar trunking system.

Failure to follow these instructions will result in death or serious injury.

Follow these rules to energize the busbar trunking system:

- The busbar trunking system should have no electrical load on it when it is energized. As the busbar trunking system may typically extend through several rooms and floors, verify that all devices fed from the busbar trunking system are in the OFF position.
- Energize the busbar trunking system in sequence, by starting at the source end and working towards the load end. Start by energizing the main devices, then the feeder devices, and then the branch-circuit devices. Turn the devices to the “ON” position with a firm positive motion.
- After the busbar trunking system has been energized, equipment such as lights, contactors, heaters, and motors can be switched on.
- It is normal for the busbar trunking system to emit a low intensity hum during operation.
- Excessive noise may be an indication of a potential problem.
 - If this occurs, it is recommended to:
 - Conduct an audio/visual inspection of busbar trunking system to locate source of origin of noise and to check for installation errors (For example: loose hardware, housing damage, misalignments and so on.)
 - If cause of noise is detected, determine actions necessary to address causes for excessive noise.
 - If source or cause of excessive noise cannot be detected, please contact Schneider Electric for assistance.

- Occurrence of sparking at any point along the busbar trunking system is not normal. If this occurs, do the following:
 - De-energize the busbar trunking system immediately.
 - Correct the cause of the sparking.
 - Conduct an insulation check again, as described in step 4 (*see page 68*), before attempting to energize.

Phase Order and Label Check			
15	Each run component and its junction blocks has the correct rating and polarity.		
16	Each run component has the correct phase order labelling.		
17	All the neutral conductors are positioned on the same side.		
18	Phase order is consistent between the end feed units.		
19	Phase order is correct before and after a phase or neutral crossover unit.		
Connection Check			
20	At the junction: • active conductors are well placed in the joint block. • two metallic sides (PE) are well placed in the joint block.		
21	Alignment at the junction between the metallic side and gasket is correct to insure the IP55 protection rating.		
22	All bolts of the joint block have been tightened to remove the red washer.		Total number of junctions:
23	All bolts of reassembled joint blocks have been checked with a torque wrench at a torque of 60 N•m.		Total number of reassembled joint blocks:
Insulation Check (Before Transformer and Switchboard Connections)			
24	No moisture is present between the conductors before connection.		
25	The insulation resistance between L1 and L2 is > 1 MΩ.		Value (MΩ)=
26	The insulation resistance between L1 and L3 is > 1 MΩ.		Value (MΩ)=
27	The insulation resistance between L2 and L3 is > 1 MΩ.		Value (MΩ)=
28	The insulation resistance between L1 and N is > 1 MΩ.		Value (MΩ)=
29	The insulation resistance between L2 and N is > 1 MΩ.		Value (MΩ)=
30	The insulation resistance between L3 and N is > 1 MΩ.		Value (MΩ)=
31	The insulation resistance between L1 and PE is > 1 MΩ.		Value (MΩ)=
32	The insulation resistance between L2 and PE is > 1 MΩ.		Value (MΩ)=
33	The insulation resistance between L3 and PE is > 1 MΩ.		Value (MΩ)=
34	The insulation resistance between N and PE is > 1 MΩ.		Value (MΩ)=
Transformer and Switchboard Connections Check			
35	Transformers or switchboards do not support the weight of the busbar.		
36	Position of the neutral is correct.		
37	Phase order is correct.		
38	Number and cross-section of the connection bars are as designed.		
39	Clearance between active conductors is > 14 mm.		
40	Clearance between active conductors and enclosures is > 20 mm (even if the standard required is 14 mm).		
41	Number and distance between bar supports can insure short-circuit withstand and clearance.		
42	PE or PEN bonds are properly connected to the equipment's earthing terminal.		
43	All bolts have been tightened at the proper torque (the torque depends on the screw size). Verified bolts are marked with varnish.		
44	Each box has been closed with its cover plate to insure the IP55 protection rating.		

QGH3492102-00 10/2018

2/2

Maintenance

Safety Instructions

 DANGER
<p>HAZARD OF ELECTRIC SHOCK, BURNS, OR EXPLOSION</p> <ul style="list-style-type: none"> • Only qualified electrical maintenance personnel should install, operate, service or maintain this equipment. • A qualified person is one who has skills and knowledge related to the construction and operation of electrical equipment and its installation, and has received safety training to recognize and avoid the hazards involved. • This document should not be viewed as sufficient for those who are not otherwise qualified to operate, service, or maintain the equipment discussed. • The successful operation of this equipment depends upon proper handling, installation, operation, and maintenance. <p>Failure to follow these instructions will result in death or serious injury.</p>

 WARNING
<p>HAZARD OF ELECTRIC SHOCK, BURNS, OR EQUIPMENT DAMAGE</p> <p>In event of electrical fault, fire, water leakage, earthquake or any similar untoward event, an immediate inspection of the equipment must be carried out.</p> <p>Failure to follow these instructions can result in death, serious injury, or equipment damage.</p>

Overview

The frequency and the level of maintenance of the Canalis KT system depend on the criticality of the application and the environmental conditions. The recommendations in this section concern only the busbar trunking system. For all devices fitted in tap-off units, the recommendations of the manufacturer must be complied with.

Basic Maintenance Procedures

Basic maintenance must be performed every year, for all types of applications, and under all conditions.

Carry out the following procedures for basic maintenance:

- Inspect the external appearance of the components, accessories, and supports.
- Check for deformation, damage, or dirt.
- Check for dislocation, bending, misalignment, and other abnormalities of the connecting covers, hangers, and plug-in units.
- Check if the joint blocks or terminals are discoloured, corroded or pitted, or show signs that they have been exposed to high temperatures.
- Check for any changes in the environment that can affect the busbar trunking system operation. These could include the presence or appearance of water, moisture, high temperature, corrosive gas, excessive vibration, dust, air circulation, or new hot air sources.
- Inspect the external appearance of tap-off units.
- Remove dust, water, oil deposits, and all other conductive bodies from the sensitive zones.
- The contacts between the busbar trunking system and tap-off units do not need specific maintenance. The contacts consist of sprung silver plated contact jaws to ensure optimum contact quality.

Procedures for Critical Installations

More specific maintenance procedures must be performed when the busbar trunking system feeds critical applications or in case of unfavorable environmental conditions.

Critical applications include those with the need for high level of continuity of service, such as secured power distribution in hospitals, IT data centers, cooling power supplies or similar applications with a high load factor.

Unfavorable conditions include: high ambient temperature, high level of humidity, dusty or polluted environments, and intensive vibrations.

Carry out the following maintenance procedures in critical environments:

- Carry out the basic maintenance procedures every year as described previously.
- Check that there is no abnormal increase in ambient temperature.
- If the busbar trunking system is accessible, carry out infrared temperature measurements on all the electrical connections (joint blocks, terminal connections, tap-off units).
- If the busbar trunking system is not accessible, install a thermal monitoring system which communicates temperatures to a remote supervision point.
- In case of abnormal temperature measurement results, check all the connections using a torque wrench. The torque for the joint block bolts should be 60 N•m (+/- 10%). If these values decrease significantly over time, consult Schneider Electric.
- If needed, the concerned material must be replaced with new factory-mounted products. Consult your local Schneider Electric office for all replacements.
- Before re-energizing the busbar trunking system, carry out an insulation test as described in the commissioning section (*see page 68*).
- After having performed all the necessary inspections and repairs mentioned above, it may be desirable to carry out infrared temperature measurements on all the electrical connections.

Appendices



What Is in This Appendix?

The appendix contains the following chapters:







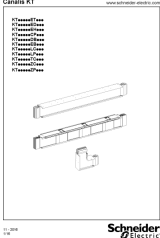

Chapter	Chapter Name	Page
A	Related Documents	77
B	Components for Volkswagen Group	81

Appendix A

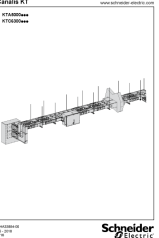

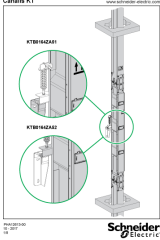

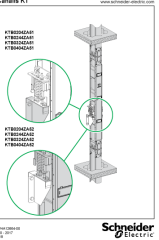





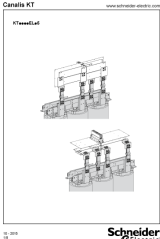

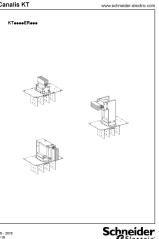
Related Documents

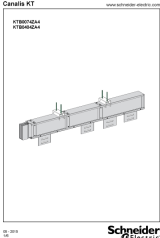

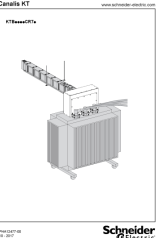

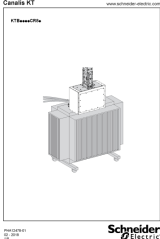

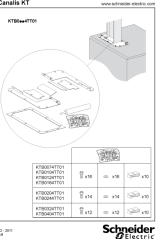



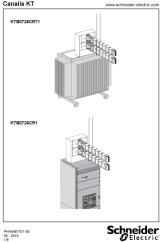

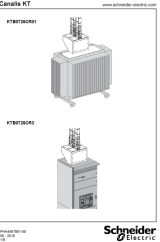
List of Instruction Sheets

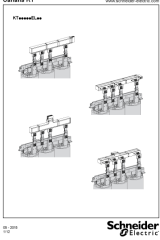
Instruction Sheets for Supports and Run Components

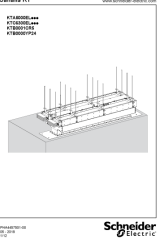



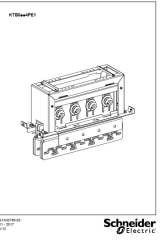





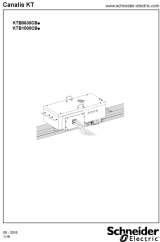

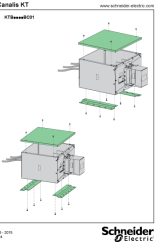
Front page	QR code and web link	Front page	QR code and web link
	 <u>AAV32038</u>		 <u>PHA33884</u>
	 <u>PHA12613</u>		 <u>PHA12664</u>

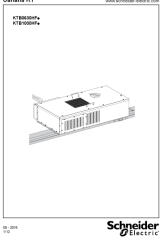

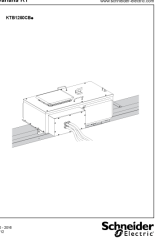

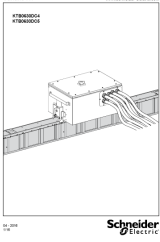

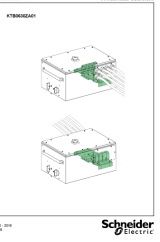

Instruction Sheets for Transformer and Switchboard Connections

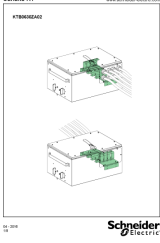
Front page	QR code and web link	Front page	QR code and web link
	 <u>AAV32030</u>		 <u>AAV17625</u>
	 <u>AAV32042</u>		 <u>PHA12477</u>
	 <u>PHA12478</u>		 <u>AAV32049</u>

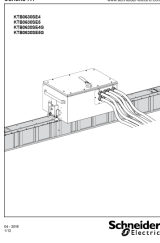

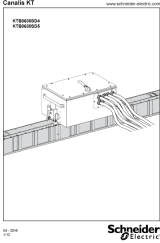
Front page	QR code and web link	Front page	QR code and web link
	 <u>PHA44577</u>		 <u>PHA44578</u>
	 <u>AAV32054</u>		 <u>PHA44575</u>
	 <u>PHA44576</u>		 <u>S1A32783</u>

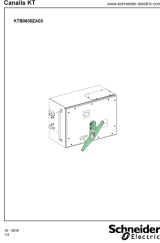
Instruction Sheets for Tap-Off Units





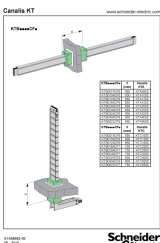



Front page	QR code and web link	Front page	QR code and web link
	 <u>AAV32051</u>		 <u>AAV32052</u>
	 <u>AAV82964</u>		 <u>BBV39803</u>
	 <u>NVE44417</u>		 <u>NVE46045</u>

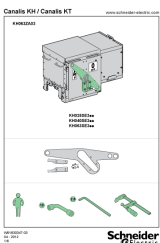

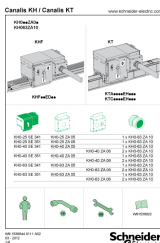
Front page	QR code and web link	Front page	QR code and web link
	 <u>NVE46746</u>		 <u>NVE47487</u>
	 <u>NVE48158</u>		 <u>NVE49438</u>

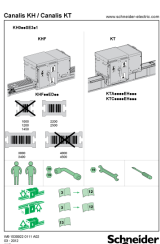
Instruction Sheets for Specific Components

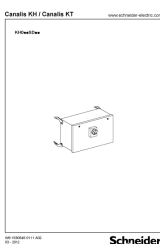

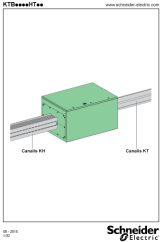

Front page	QR code and web link	Front page	QR code and web link
	 <u>S1A68982</u>		

Instruction Sheets for Canalis KH / Canalis KT Components

Front page	QR code and web link	Front page	QR code and web link
	 <u>1630347</u>		 <u>1530944</u>
	 <u>1530922</u>		 <u>1530545</u>

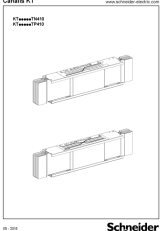
Front page	QR code and web link	Front page	QR code and web link
 <p>KT20000T100 www.schneider-electric.com</p> <p>Canalis KT</p> <p>Schneider Electric</p>	 <p><u>S1B20566</u></p>	<p>—</p>	<p>—</p>

Miscellaneous Instruction Sheets

Front page	QR code and web link	Front page	QR code and web link
 <p>Canalis KT www.schneider-electric.com</p> <p>AAV20832</p> <p>Schneider Electric</p>	 <p><u>AAV20832</u></p>	 <p>Canalis KT www.schneider-electric.com</p> <p>AAV32046</p> <p>Schneider Electric</p>	 <p><u>AAV32046</u></p>

Appendix B

Components for Volkswagen Group

What Is in This Chapter?

This chapter contains the following topics:

Topic	Page
Installation of KTB0244ZA6 Top Supports	82
Installation of KH040SD9502 or KH063SD9502 Plug-In Tap-Off Units	83
Installation of KTA2500GK•1 Grounding Kits and KTA2500RL•• Coupling Isolators	86
List of Instruction Sheets	87

Installation of KTB0244ZA6 Top Supports

Introduction

KTB0244ZA6 top supports enable the KTA2500 run components to be supported from the top so that tap-off units can be installed on the bottom of the run. The KTB0244ZA6 top supports are installed below a standard C profile support.

Procedure for Installing KTB0244ZA6 Top Supports

The procedure for installing the KTB0244ZA6 top supports is described in the instruction sheet [EAV50318](#), available on the Schneider Electric website.

Step	Action
1	Define the position of the supports on the run (<i>see page 82</i>). The maximum allowed distance between two supports is 2 m.
2	Install standard C profile supports (not supplied) on the wall or any other construction frame capable of supporting the weight of the run.
3	Lift the run component up to the C profile supports and maintain it in place below the supports.
4	Install one half of the KTB0244ZA6 top support on one side of the run component for each C profile support, using the bolts and washers provided. Tighten the bolts to a torque of 20 N•m.
5	Push the run component against the installed side of the KTB0244ZA6 support and install the second side of each support in the same way as the first side.

Positioning the KTB0244ZA6 Top Supports on the Run Component

KTB0244ZA6 top supports can only be installed in certain areas of the run component, as illustrated here:

KT2500ET•••• run component:

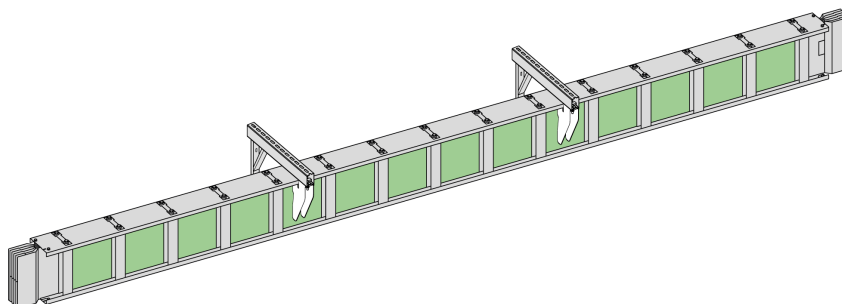

KT2500EH•••• run component:

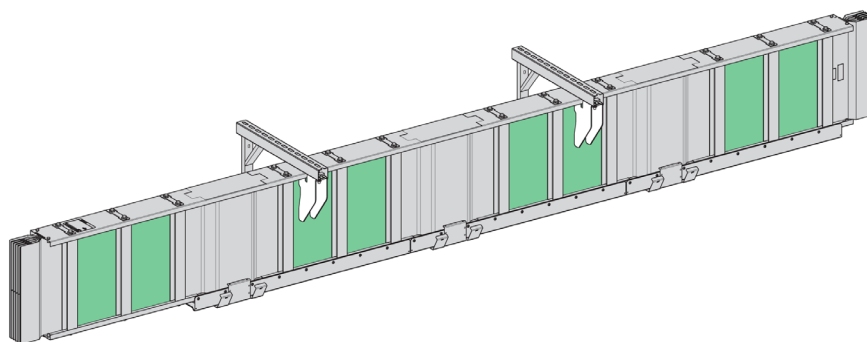

Areas where the KTB0244ZA6 top supports can be installed

Installation of KH040SD9502 or KH063SD9502 Plug-In Tap-Off Units

Introduction

DANGER

HAZARD OF ELECTRIC SHOCK, EXPLOSION OR ARC FLASH

- Beware of potential hazards.
- Do not open or close the cover of a tap-off unit with the downstream load energized.
- Carefully inspect the work area for tools and objects that may have been left inside the tap-off unit.

Failure to follow these instructions will result in death or serious injury.

Plug-in tap-off units can be plugged in and unplugged from the run when the run is live. KH040SD9502 and KH063SD9502 plug-in tap-off units from the Canalis KH system are compatible with the Canalis KT system. They can be installed on the KT ••••EH••• run component.



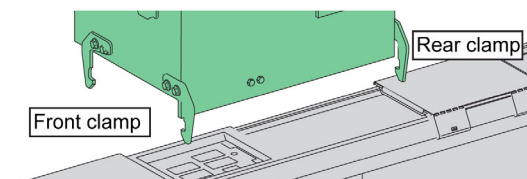

The tap-off unit is fixed on the run component with front and rear clamps. The front clamps enable automatic installation on the run component. The rear clamps are only accessible when the tap-off unit disconnecter is switched off. This prevents the tap-off unit being plugged in or unplugged when the load is connected.

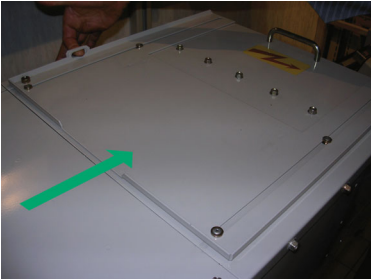
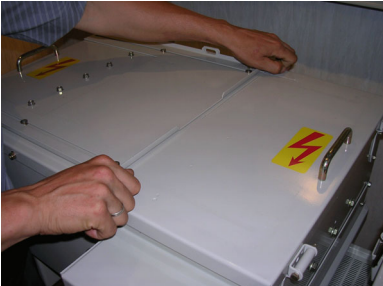
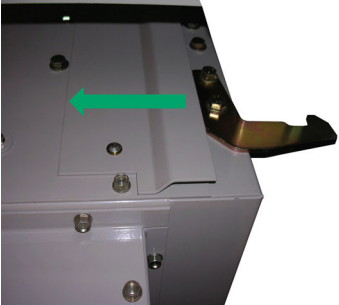
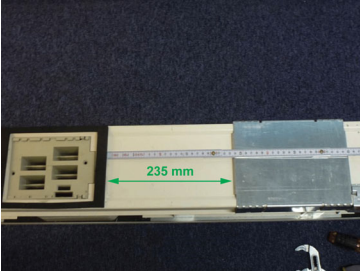

Procedure for the Installation of KH040SD9502 or KH063SD9502 Plug-In Tap-Off Units

Follow this procedure to install the tap-off unit on the run component:

Step	Action	
1	Switch off the disconnecter and remove the fuse support from the tap-off unit.	
2	Slide the shutter forward in order to access the cable connection compartment.	
3	Open the cable connection compartment. Opening this compartment also gives access to the rear clamps.	
4	Check that the rear clamps are accessible.	
5	<p>Before inserting the tap-off unit, loosen the four corners of the outlet cover and slide it to the right. The cover is stored in this position for future use.</p> <p>When the cover is in the storage position, the distance between the gasket and the cover is 235 mm.</p>	

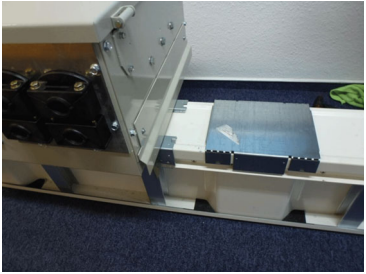
Step	Action	
6	Check that the protection device is switched off and carefully inspect the tap-off unit for tools and objects that may have been left inside the tap-off unit.	
7	Install the tap-off unit on the run component using the fixing mechanism.	
8	Connect the cables to the tap-off unit.	-
9	Close the cable connection compartment door and slide back the shutter.	-
10	Install the fuse support and perform electrical tests. Switch on the disconnecter.	-

Installation of KTA2500GK•1 Grounding Kits and KTA2500RL•• Coupling Isolators

Introduction

⚡ ⚠ DANGER

HAZARD OF ELECTRIC SHOCK, EXPLOSION OR ARC FLASH

- Only qualified electrical maintenance personnel should install, operate, service or maintain this equipment.
- The procedures provided by Volkswagen Group must be followed while working with this equipment.

Failure to follow these instructions will result in death or serious injury.

The KTA2500GK•1 grounding kit consists of:

- A 1 m run component.
- A unit containing a shunt, bolted on top of the run component.

The KTA2500GK•1 grounding kit is installed on a section of a run, between two KTA2500RL•• coupling isolators.

When the busbar trunking system is not energized, the KTA2500GK•1 grounding kit enables all the active conductors to be linked to the protective earth conductor during maintenance operations. The section must be isolated from the power supply by switching off the coupling isolators at the two ends of the section



Procedure for the Installing the KTA2500GK•1 Grounding Kit







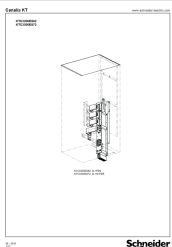

Follow the procedures provided by Volkswagen Group for installing the KTA2500GK•1 grounding kit.

Procedure for the Installing the KTA2500RL•• Coupling Isolator

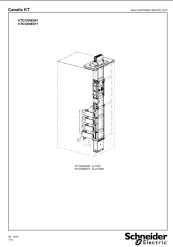
The procedure for installing the KTA2500RL•• coupling isolator is described in the instruction sheet [AAV32041](#), available on the Schneider Electric website.

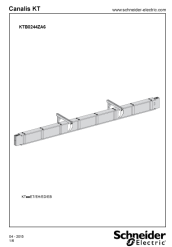
List of Instruction Sheets

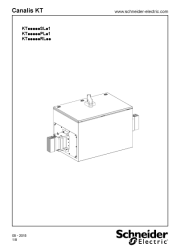
Instruction Sheets for Volkswagen Group

Front page	QR code and web link	Front page	QR code and web link
	 <u>S1B96818</u>		 <u>S1B96819</u>
	 <u>EAV50318</u>		 <u>AAV32041</u>



QGH6252900-01

Schneider Electric Industries SAS

35, rue Joseph Monier
CS30323
F - 92506 Rueil Malmaison Cedex

www.schneider-electric.com

As standards, specifications and designs change from time to time, please ask for confirmation of the information given in this publication.