

1SNA115688R2500 ✓ ACTIVE

ENTRELEC | ENTRELEC SNA

TE Internal #: 1SNA115688R2500

Modular Terminal Blocks, Disconnect, Screw Clamp Terminal Block,  
Gray, Product Spacing .314 in [8 mm], 2 Position, Screw Terminal,  
ENTRELEC SNA

[View on TE.com >](#)



Connectors > Terminal Blocks & Strips > Modular Terminal Blocks

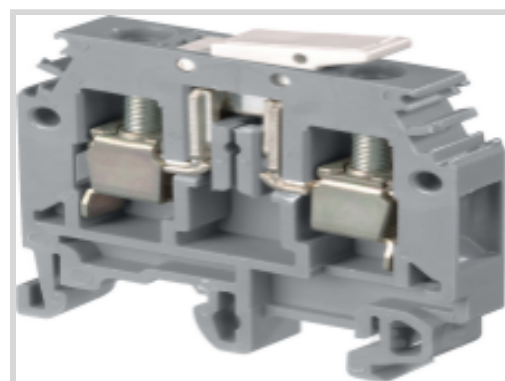

Block Function: **Disconnect**

Modular Terminal Block Product Type: **Screw Clamp Terminal Block**

Rated Cross Section: **6 mm<sup>2</sup>**

Primary Product Color: **Gray**

## Features

### Product Type Features

Modular Terminal Block Product Type	Screw Clamp Terminal Block
-------------------------------------	----------------------------

### Configuration Features

Gauge Type	A5
Number of Levels	1
Number of Poles	2
Number of Circuits	1
Block Function	Disconnect
Number of Positions	2

### Electrical Characteristics

Operating Voltage Rating (UL & CSA) (Max) - Main Circuit	300 V
Impulse Withstanding Voltage Rating (IEC)	4000 V
Voltage Rating (CSA)	600 V
Current Rating (CSA)	20 A
Dielectric Test Voltage	2500 V
Short-Time Withstanding Current Rating @ 1s	180 A
Voltage Rating (IEC)	400 V
Current Rating (UL)	20 A
Current Rating (IEC)	15 A

Voltage Rating	400 VAC
----------------	---------

### Body Features

Product Weight	19 g[.67 oz]
Primary Product Color	Gray

### Termination Features

Termination Method to Wire & Cable	Screw Terminal
------------------------------------	----------------

### Mechanical Attachment

DIN Rail Mounting Type	G32, TH35-15, TH35-7.5
Tightening Torque	7.1 in-lbs
Terminal Block Disconnect Type	Blade
Connector Mounting Type	DIN Rail

### Housing Features

Housing Material	Polyamide 6.6
------------------	---------------

### Dimensions

Main Circuit Capacity - 1 Rigid Stranded Conductor per Screw Clamp	.5 – 4 mm <sup>2</sup>
Wire Stripping Length	12 mm[.472 in]
Main Circuit Capacity - 1 Flexible Conductor per Spring Clamp	.5 – 6 mm <sup>2</sup>
Product Depth	44.5 mm
Product Width	8 mm[.314 in]
Product Length	44.5 mm
Product Height	47 mm
Rated Cross Section	6 mm <sup>2</sup>
Product Spacing	8 mm[.314 in]
Wire Size	6 mm <sup>2</sup>

### Usage Conditions

Storage Temperature Range	-55 – 110 °C[-67 – 230 °F]
Installation Temperature Range	-5 – 40 °C[23 – 104 °F]
Operating Temperature Range	-55 – 110 °C[-67 – 230 °F]

### Operation/Application

Circuit Application	Signal
---------------------	--------

### Industry Standards



IP Rating	IP20
UL Flammability Rating	UL 94V-0

### Product Compliance

[For compliance documentation, visit the product page on TE.com>](#)

EU RoHS Directive 2011/65/EU	Compliant
EU ELV Directive 2000/53/EC	Compliant
China RoHS 2 Directive MIIT Order No 32, 2016	No Restricted Materials Above Threshold
EU REACH Regulation (EC) No. 1907/2006	Current ECHA Candidate List: JUNE 2022 (224) Candidate List Declared Against: JUNE 2022 (224) Does not contain REACH SVHC
Halogen Content	Low Halogen - Br, Cl, F, I < 900 ppm per homogenous material. Also BFR/CFR/PVC Free
Solder Process Capability	Not reviewed for solder process capability

#### Product Compliance Disclaimer

This information is provided based on reasonable inquiry of our suppliers and represents our current actual knowledge based on the information they provided. This information is subject to change. The part numbers that TE has identified as EU RoHS compliant have a maximum concentration of 0.1% by weight in homogenous materials for lead, hexavalent chromium, mercury, PBB, PBDE, DBP, BBP, DEHP, DIBP, and 0.01% for cadmium, or qualify for an exemption to these limits as defined in the Annexes of Directive 2011/65/EU (RoHS2). Finished electrical and electronic equipment products will be CE marked as required by Directive 2011/65/EU. Components may not be CE marked. Additionally, the part numbers that TE has identified as EU ELV compliant have a maximum concentration of 0.1% by weight in homogenous materials for lead, hexavalent chromium, and mercury, and 0.01% for cadmium, or qualify for an exemption to these limits as defined in the Annexes of Directive 2000/53/EC (ELV). Regarding the REACH Regulation, the information TE provides on SVHC in articles for this part number is based on the latest European Chemicals Agency (ECHA) 'Guidance on requirements for substances in articles' posted at this URL: <https://echa.europa.eu/guidance-documents/guidance-on-reach>

### Compatible Parts

 <p>TE Part # 1SNA103775R0000 RC65-BL</p>	 <p>TE Part # 1SNA103776R0100 RC65-RD</p>	 <p>TE Part # 1SNA114825R0500 SCFM6</p>	 <p>TE Part # 1SNA116538R1700 PC8-2</p>
--	---	--	--



TE Part # 1SNA116539R1000  
PC8-3



TE Part # 1SNA116540R2500  
PC8-4



TE Part # 1SNA163313R2400  
PC8-10



TE Part # 1SNA173060R0000  
DCO

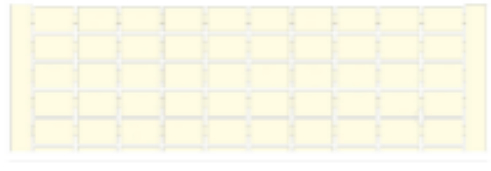

TE Part # 1SNA206230R1100  
RC610-GN

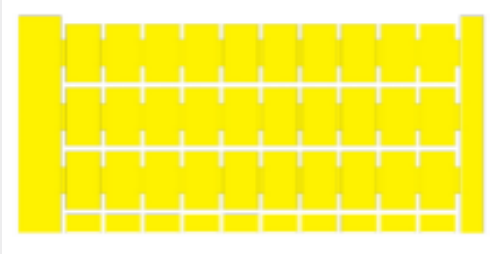

TE Part # 1SNA206231R0600  
RC610-YL

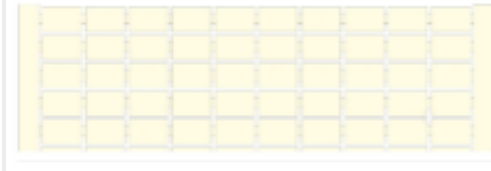

TE Part # 1SNA206232R0700  
RC610-OR

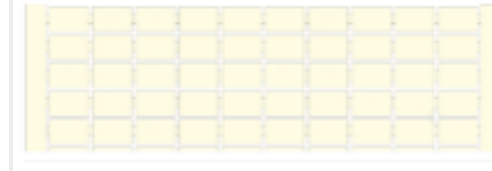

TE Part # 1SNA206233R0000  
RC610-BL

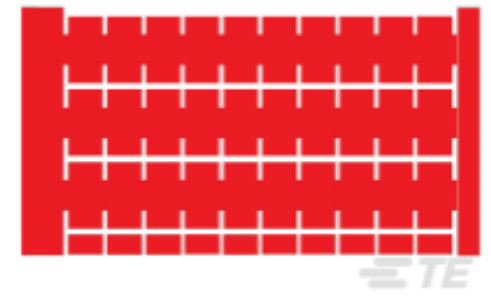

TE Part # 1SNA206235R0200  
RC610-RD



TE Part # 1SNA232000R0000  
RC65



TE Part # 1SNA233000R0100  
RC610

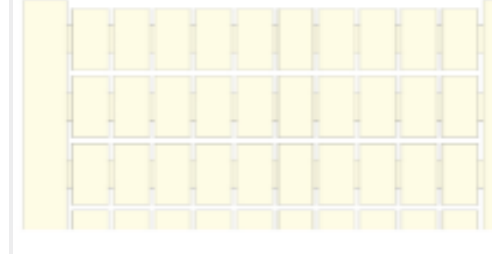

TE Part # 1SNA234000R0200  
RC810



TE Part # 1SNA007865R2600  
FC2

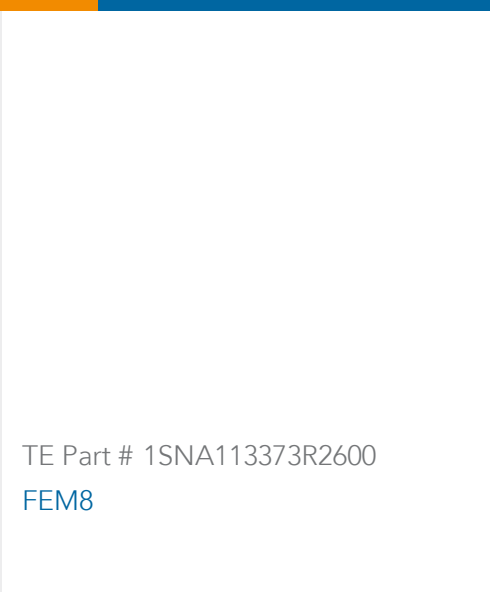

TE Part # 1SNA113373R2600  
FEM8

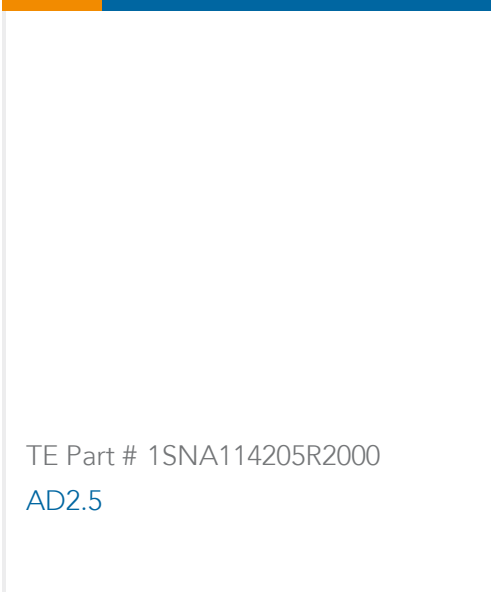

TE Part # 1SNA114205R2000  
AD2.5

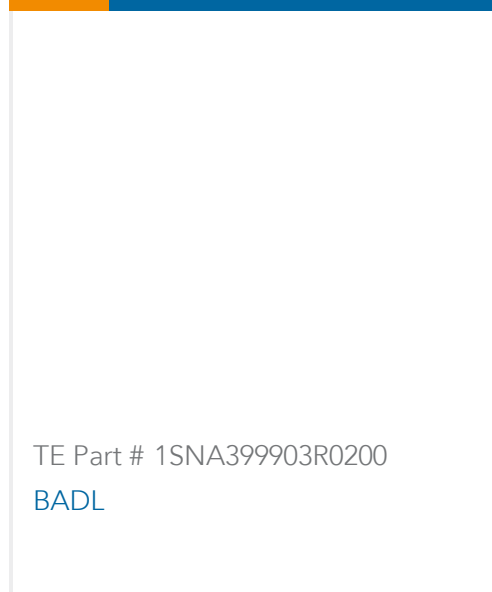

TE Part # 1SNA399903R0200  
BADL

Also in the Series | **ENTRELEC SNA**



Modular Terminal Blocks(182)



Terminal Block & Strip Conducting Accessories(26)



Terminal Block & Strip Insulating Accessories(14)

Customers Also Bought



TE Part #1SNA115237R1000  
M6/8.ST1



TE Part #1SNA115243R2600  
M6/8.ST7



TE Part #1SNA115486R0300  
MA2.5/5



TE Part #1SNA125129R1600  
M16/12.N



TE Part #1SNA165130R2300  
M16/12.P



TE Part #1SNK900652R0000  
SC-JB8-2



TE Part #1SNK900654R0000  
SC-JB8-4

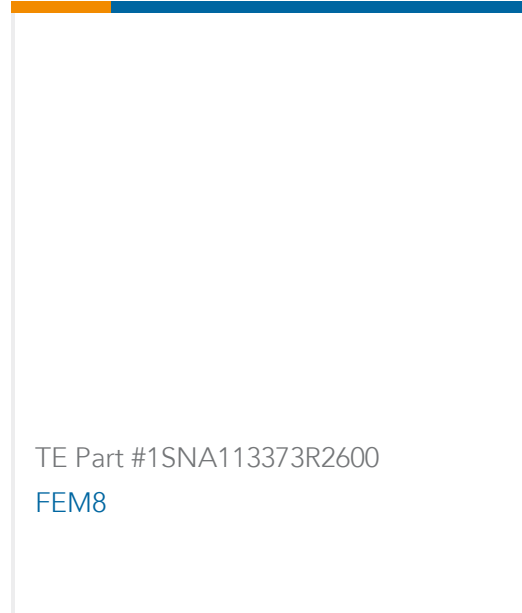

TE Part #1SNA113373R2600  
FEM8

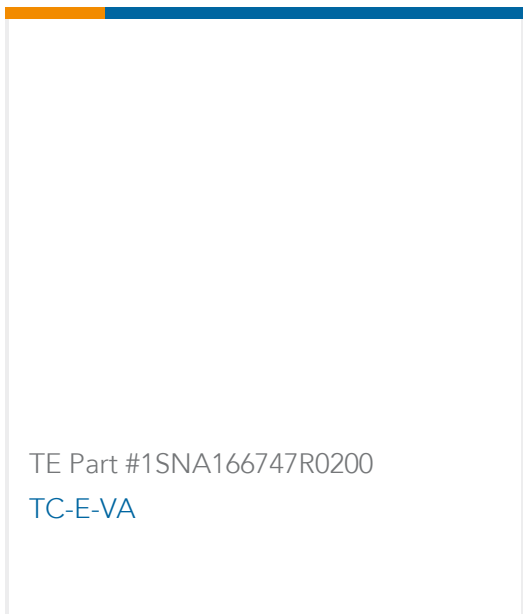

TE Part #1SNA166747R0200  
TC-E-VA



TE Part #1SNA179726R0200  
AJS9

## Documents

### CAD Files

3D PDF

3D

Customer View Model

[ENG\\_CVM\\_CVM\\_1SNA115688R2500\\_A.2d\\_dxf.zip](#)

English

Customer View Model

[ENG\\_CVM\\_CVM\\_1SNA115688R2500\\_A.3d\\_igs.zip](#)

English

Customer View Model

[ENG\\_CVM\\_CVM\\_1SNA115688R2500\\_A.3d\\_stp.zip](#)

English

By downloading the CAD file I accept and agree to the [Terms and Conditions](#) of use.

### Datasheets & Catalog Pages

[Catalogue - ENTRELEC terminal-blocks-sna-series](#)

English

[M6/8.SNB](#)

English

1SNA115688R2500

Modular Terminal Blocks, Disconnect, Screw Clamp Terminal Block, Gray, Product  
Spacing .314 in [8 mm], 2 Position, Screw Terminal, ENTRELEC SNA



## ENTRELEC Terminal Blocks Catalogue (RUS)