



Product designation
Product type designation

Probe
CGL125

Connections

Terminals type

Threaded rod
with nut

Ambient conditions

Temperature

Operating temperature

max °C +180

Maximum operating pressure

bar 10

Housing

Weight

g 126

Dimensions

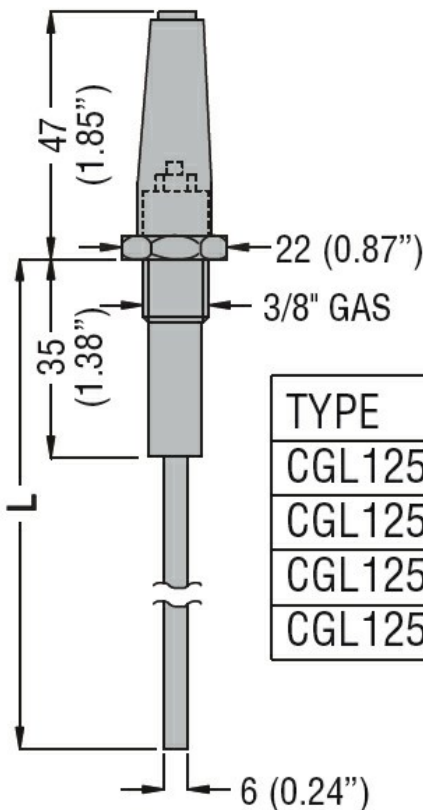

TYPE	L
CGL125 3	327 (12.87")
CGL125 5	500 (19.68")
CGL125 7	700 (27.56")
CGL125 10	1000 (39.37")

Certifications and compliance

Compliance

/

Certificates

EAC

ETIM classification

ETIM 8.0

EC010106 -
Liquid level
sensor