

Consumer Units PMF



- Flush-mounted consumer units with sheet-steel door PMF
- Tested according to EN 60670 and EN 62208
- Rated current up to 63 A
- Degree of protection IP40
- 12 modules per a row, can be extended to 14
- 1 up to 5 rows
- White (RAL 9016) colour of the door
- Easy mounting into hollow walls
- Mounting depth 87 mm only
- Wall box with a relief for mechanical fixing of cables

Consumer units PMF are intended mainly for domestic applications. Their design is suitable for flush mounting. Dual fixing system allows using also for hollow walls. Tested with glow wire test at 850°C. The height-adjustable front metal frame allows to compensate wall surface imperfections.

The units are available in versions from 12 up to 60 modules with 12 (+2) modules per a row. Degree of protection is IP40, degree of protection against mechanical impact IK06.

Scope of delivery consists of enclosure, metal frame with door, mounting frame with device DIN rails, N + PE terminals, sealable front cover with device cutout, cover for empty place, mounting material and instructions.

Type Key

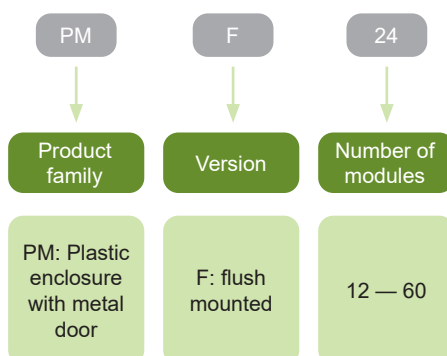

Certification marks



Consumer Units PMF

Consumer units PMF with white metal door

- Flush mounted
- 12 (+2) modules per row
- 1 up to 5 rows
- Scope of delivery: enclosure, metal frame with door, mounting frame with device DIN rails, insulated N + PE terminals, sealable front cover with device cutout, cover for empty place, mounting material and instructions



N+PE terminals	Number of rows	Total modules	Article No.	Type	Packing
10 + 10	1	12 (+2)	107101	PMF 12	1
13 + 13	2	24 (+4)	107102	PMF 24	1
15 + 15	3	36 (+6)	107103	PMF 36	1
20 + 20	4	48 (+8)	107104	PMF 48	1
30 + 30	5	60 (+10)	107262	PMF 60	1

Spare metal frame with door

- Spare metal frame with door for PMF line consumer unit
- Packed separately



For consumer units	Article No.	Type	Packing
PMF 12	107105	DR PMF 12	1
PMF 24	107106	DR PMF 24	1
PMF 36	107107	DR PMF 36	1
PMF 48	107108	DR PMF 48	1
PMF 60	107263	DR PMF 60	1

Lock with key

- Lock with key
- For subsequent mounting onto enclosure door



Version of lock	For consumer units	Article No.	Type	Packing
Metal	PMF, PNS-SD	105494	LK PM M	1

Connection bracket

- For PMF line of consumer units only
- Connection bar for series installation of several enclosures
- Made from zinc steel sheet
- Installation: 2 pieces for two enclosures



Description	Article No.	Type	Packing
Vertical connection bracket PMF	107280	VCB PM	1
Horizontal connection bracket PMF	108053	HCB PM	1

Consumer Units PMF

Additional insulated terminal

- Additional insulated terminal with holder, one insulated terminal in the standard scope of delivery
- Grey colour
- 2 x 10 or 2 x 15 terminals
- PMF consumer units allow to mount terminals on the top as well as bottom



Description	Number of N + PE terminals	Article No.	Type	Packing
Insulated terminal	10 + 10	109053	TH CUB D	1
Insulated terminal	15 + 15	101577	TH CUB P	1

Holder for double terminal

- Adding possibility to connect two insulate terminals together
- 1 set = 2 pieces (one per side)



Description	Article No.	Type	Packing
Holder for double terminal	110820	DTH	1 set

Covers for empty places

- Covers for unused 45 mm device cutout
- White, grey or black colour
- Total width 224 mm, can be shortened
- Segmented as 1x 15 mm, 22 x 1/2 module width, 1x 15 mm



Colour	Width	Article No.	Type	Packing
White	224 mm	101574	B CC45	1/500
Grey	224 mm	113277	B CC45 G	1/500
Black	224 mm	110192	B CC45 B	1/500

Spare mounting material

- For PMF line mounted consumer units
- Scope of delivery SMM PMF: wall holders (including hollow walls), stickers, empty place cover, screws
SDDA PMF: height-adjustable pads and lock parts for front cover, screws
- Spare parts, both packages are in the standard scope of delivery



Description	Article No.	Type	Packing
Spare mounting material, PMF	107120	SMM PMF	1 set
Height-adjustable pads for front cover, PMF	107122	SDDA PMF	1 set

Spare lock

- For PMF and PNS-SD line of consumer units
- Spare part, lock is in the standard scope of delivery



Description	Article No.	Type	Packing
Spare lock, PMF, PNS-SD	107121	SL PMF	1

Technical Data PMF

Flush-mounted plastic consumer units with sheet-steel doors

General parameters

Consumer units for domestic applications

Flush-mounted version, suitable also for hollow-walls mounting

Scope of delivery: enclosure, metal frame with door, mounting frame with device DIN rails, N + PE terminals, sealable front cover with device cutout, cover for empty place, mounting material and instructions

Electrical parameters

Tested according to	EN 62208, EN 60670
Rated operational voltage U_e	400 V AC
Rated current I_e	up to 63 A
Rated frequency	50 Hz
Insulation voltage U_i	400 V AC
Degree of protection	IP40
Degree of protection against mechanical impact	IK06
Protection class	II
Operating temperature	-25°C – +60°C
Maximum power dissipation of all installed devices at ambient temperature 30 °C	
PMF 12	31 W
PMF 24	40 W
PMF 36	50 W
PMF 48	60 W
PMF 60	70 W

Mechanical parameters

Glow-wire test	850 °C
Used plastics	Halogen-free
Metal parts colour	powder coated, white, flat, RAL 9016

Mechanical parameters

1.	enclosure wall box with N+PE terminals
2.	removable top and bottom box side with cable cutout relief
3.	DIN-rail mounting frame
4.	sealable front cover with device cutout
5.	front metal frame with door

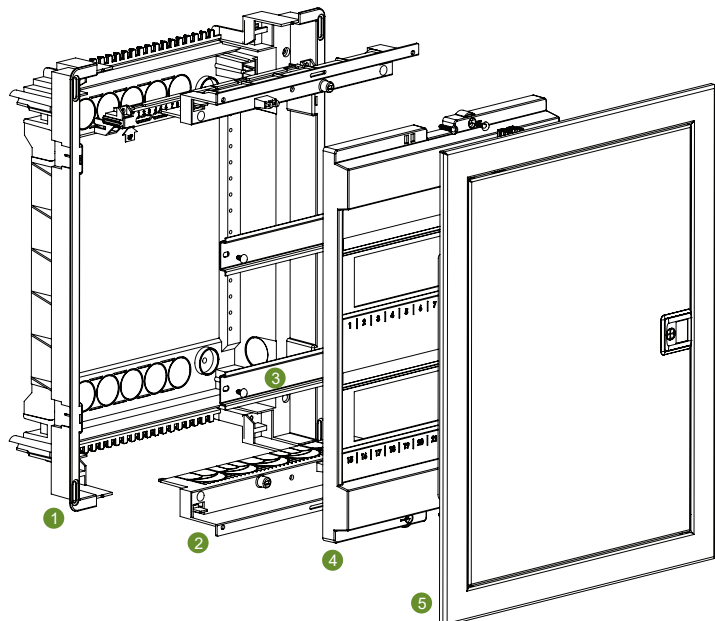

Technical Data PMF

Flush-mounted plastic consumer units with sheet-steel doors

Dimensional drawings

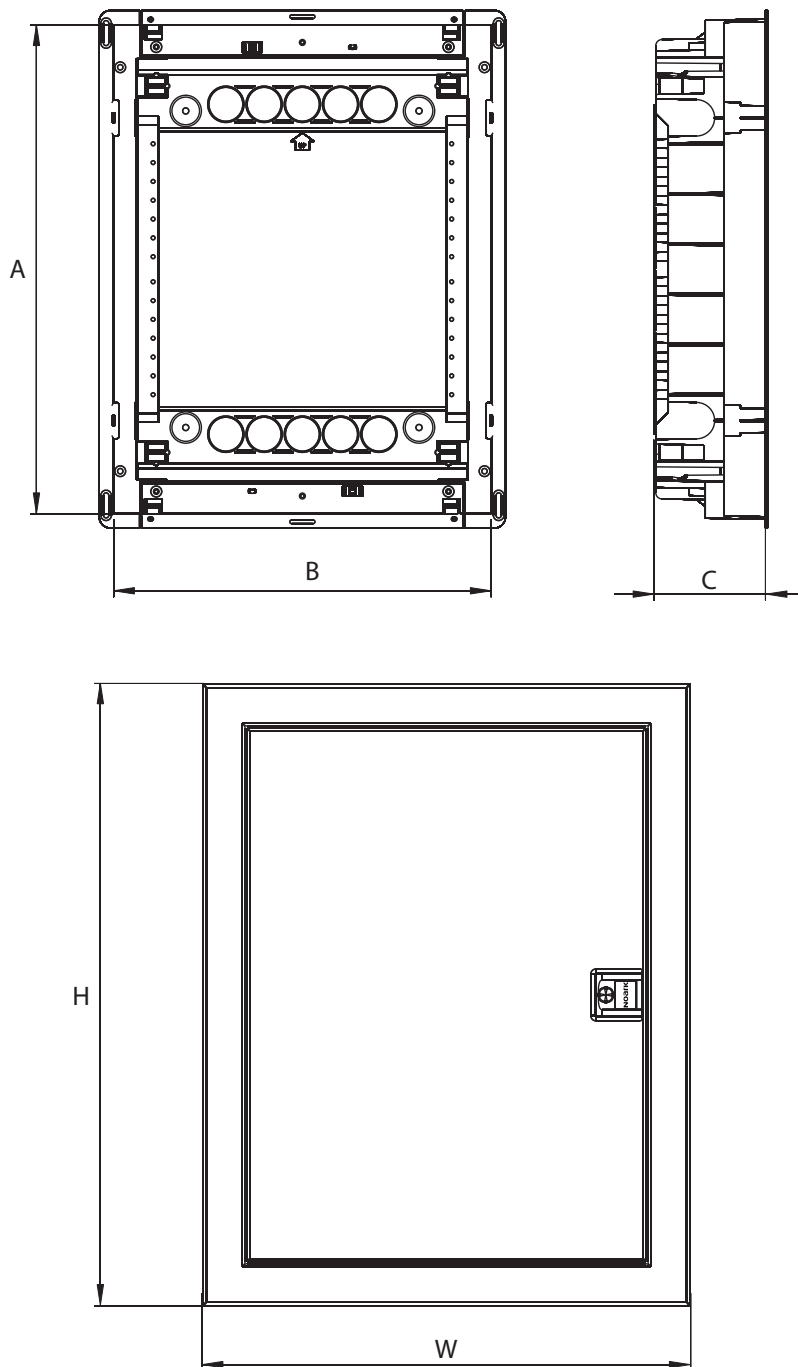

Dimensions

Type	Dimensions [mm]					Weight [kg]
	A	B	C	H	W	
PMF 12	274	306	87	317	346	2.0
PMF 24	399	306	87	442	346	2.5
PMF 36	549	306	87	592	346	3.0
PMF 48	673	306	87	717	346	3.5
PMF 60	799	306	87	842	346	4.5