

THIS COPY IS PROVIDED ON A RESTRICTED BASIS AND IS NOT TO BE USED IN ANY WAY DETRIMENTAL TO THE INTERESTS OF PANDUIT CORP.

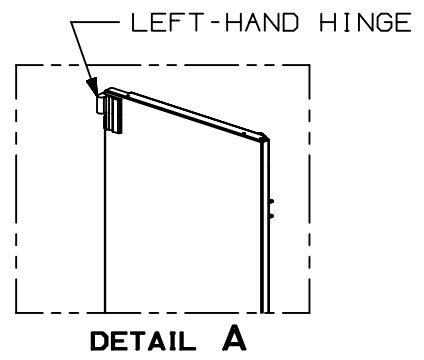
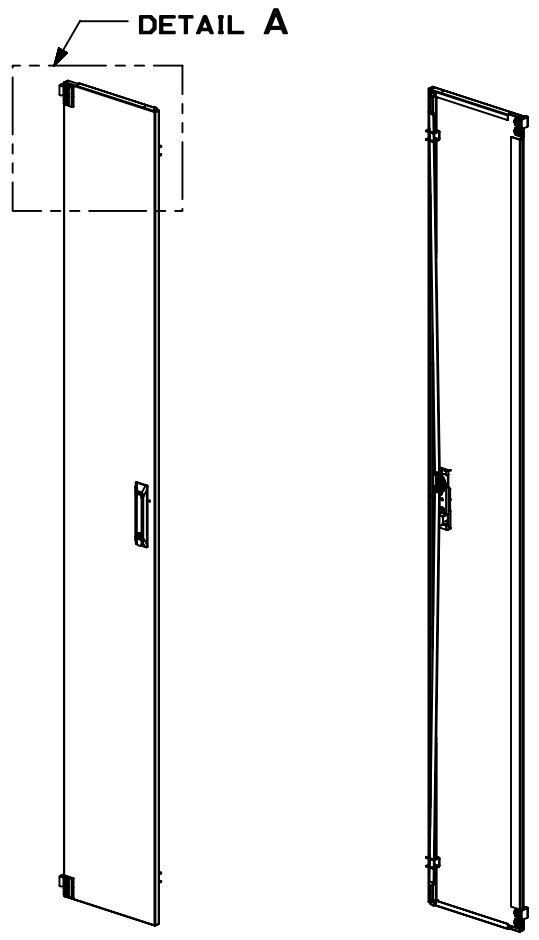

- NOTES:
- VISIT OUR ON-LINE CATALOG AT WWW.PANDUIT.COM FOR A LIST OF CURRENT PARTS APPLICABLE FOR USE WITH THIS PRODUCT.
 - PRIMARY DIMENSIONS ARE IN MILLIMETERS.
 - PARTS SUPPLIED:

PARTS SUPPLIED (LEFT):
 (1) LEFT-HAND HINGING ODF DOOR
 (4) #12-24 MOUNTING SCREWS
 (4) #12 EXTERNAL TOOTH WASHERS
 MATERIAL TO CHANGE TO:
 RIGHT-HAND HINGING
 (2) RIGHT-HAND HINGES

PARTS SUPPLIED (RIGHT):
 (1) RIGHT-HAND HINGING ODF DOOR
 (4) #12-24 MOUNTING SCREWS
 (4) #12 EXTERNAL TOOTH WASHERS
 MATERIAL TO CHANGE TO:
 LEFT-HAND HINGING
 (2) LEFT-HAND HINGES

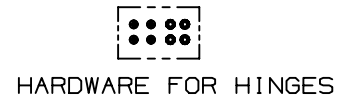
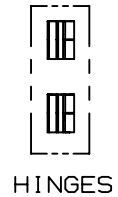

PART SUPPLIED
 (SEE NOTE 3)

LEFT-HAND HINGING DOOR

ISO VIEW - FRONT ISO VIEW - REAR

02A	9/14/21	LEE	MCIS	ANJA & GB-SJMO	DRAWING RELEASE				V09002TW/07
REV	DATE	BY	CHK	APR	DESCRIPTION				ECN

TITLE		ODF SPLIT FRONT DOOR (FDUFD3045SR** & FDUFD3045SL**)		
		CUSTOMER DRAWING		
ITEM REVISION NAME		00676EAT/02		
DATASET FILE NAME		00676EAT_DC/02A		
		MATERIAL:		
		N/A		
		DRAWING NUMBER:		
		00676EAT_DC		
DRAWN BY		DATE	CHK	SCALE
LEE		9/14/21	MCIS	NONE
		THIRD ANGLE PROJECTION		
		SHT 1 OF 3		SIZE
				A

XGLOBAL-ASIZE

THIS COPY IS PROVIDED ON A RESTRICTED BASIS AND IS NOT TO BE USED IN ANY WAY DETRIMENTAL TO THE INTERESTS OF PANDUIT CORP.

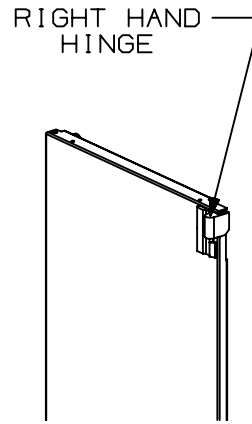
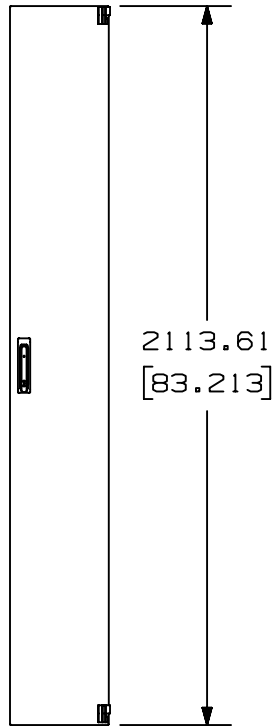
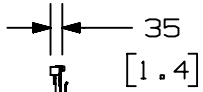
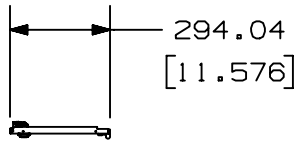

DETAIL B

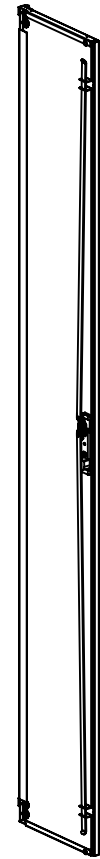
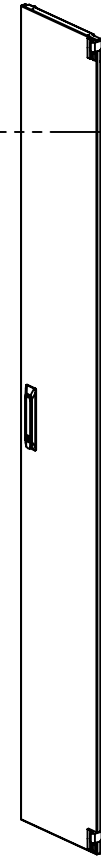
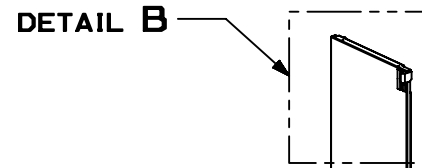

RIGHT-HAND HINGING DOOR

ISO VIEW - FRONT ISO VIEW - REAR

02A	9/14/21	LEE	MCIS	ANJA & GB-SJMO	DRAWING RELEASE	V09002TW/07
REV	DATE	BY	CHK	APR	DESCRIPTION	ECN

TITLE ODF SINGLE HINGE FRONT DOOR (FDUFD3045SR** & FDUFD3045SL**) CUSTOMER DRAWING					
ITEM REVISION NAME 00676EAT/02			PANDUIT		
DATASET FILE NAME 00676EAT_DC/02A					
MATERIAL N/A					DRAWING NUMBER: 00676EAT_DC
DRAWN BY LEE		DATE 9/14/21	CHK MCIS	SCALE NONE	SHT 2 OF 3
		THIRD ANGLE PROJECTION		SIZE A	

2

1

