

DE MONTAGEANLEITUNG
EN MOUNTING INSTRUCTIONS
FR INSTRUCTIONS DE MONTAGE
IT ISTRUZIONI DI MONTAGGIO
ES INSTRUCCIONES DE MONTAJE
NL MONTAGEHANDLEIDING
PL INSTRUKCJA MONTAŻU



TRILUX
SIMPLIFY YOUR LIGHT

AMATRIS G4 SP

AMATRIS G4 C04 SP 140 ...
AMATRIS G4 C04 SP 220 ...
AMATRIS G4 C04 SP 260 ...
AMATRIS G4 C07 SP 280 ...

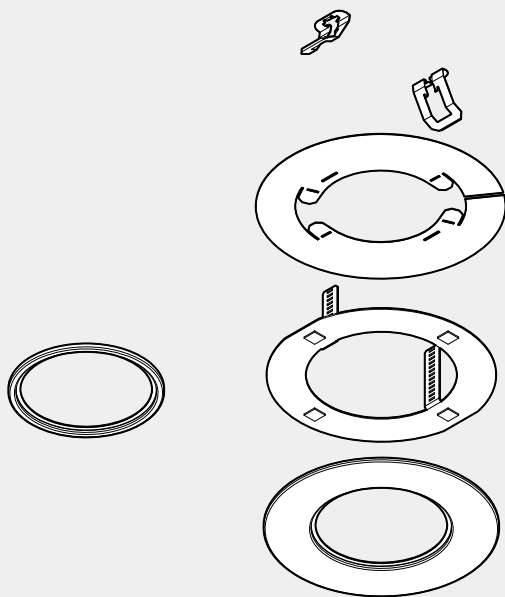

10331996 | 230901



AMATRIS G4 SP

DE

Zu Ihrer Sicherheit

Lesen Sie sorgfältig alle Hinweise und Montageschritte. Bewahren Sie die Anleitung für Wartungs- oder Demontearbeiten auf.

Erläuterung der Warnstufen

Beachten und befolgen Sie die Warnhinweise. Nichtbeachten der Warnhinweise kann zu Verletzungen oder Sachschäden führen!



WARNUNG! Kennzeichnet Gefahren, die schwere und/oder tödliche Verletzungen zur Folge haben können.



VORSICHT! Kennzeichnet Gefahren, die zu Verletzungen oder Gesundheitsgefährdungen führen können.



WICHTIG. Kennzeichnet Gefahren, die zu Sachschäden oder Funktionsstörungen führen können.



TIPP. Kennzeichnet Informationen, die einen Ratschlag oder nützlichen Hinweis enthalten.

Erläuterung von Warnhinweisen und anleitenden Piktogrammen



WARNUNG! Der elektrische Anschluss muss durch fachkundiges Personal, das ausgebildet und befugt ist, erfolgen.



WARNUNG! Die Montage muss durch fachkundiges Personal, das ausgebildet und befugt ist, erfolgen.



WARNUNG! Gefahr eines elektrischen Schlages! Arbeiten Sie niemals bei anliegender elektrischer Spannung.



WARNUNG! Beachten Sie die zusätzliche Montageanleitung (10315634; 10325558) der dazugehörigen Leuchte.

Bestimmungsgemäße Verwendung

Bestimmt als Zubehör für **AMATRIS G4 ...**

EN

For your safety

Read all instructions and mounting steps carefully. Keep the instructions for maintenance or disassembly work.

Explanation of the warning levels

Observe and follow the warnings. Non-observance of the warnings may lead to injuries or material damage!



WARNING! Indicates dangers which can result in serious and/or fatal injuries.



CAUTION! Indicates dangers which can result in injuries or health hazards.



NOTICE. Indicates dangers which can result in material damage or malfunctions.



TIP. Indicates information containing advice or a useful note.

Explanation of warning messages and instructional pictograms



WARNING! The electrical connection must be carried out by professional personnel who are trained and authorised.



WARNING! The assembly must be carried out by professional personnel who are trained and authorised.



WARNING! Risk of electric shock! Never work with electrical voltage applied.



WARNING! Observe the additional installation instructions (10315634; 10325558) for the associated luminaire.

Intended use

Intended as accessories for **AMATRIS G4 ...**

AMATRIS G4 SP

FR

Pour votre sécurité

Lisez attentivement toutes les remarques et étapes de montage. Conservez ces instructions pour des travaux d'entretien ou de démontage.

Explication des niveaux d'avertissement

Respectez et suivez les avertissements. Le non-respect des avertissements peut entraîner des blessures ou des dommages matériels !



AVERTISSEMENT ! Signale des risques pouvant résulter dans des blessures graves et/ou mortelles.



ATTENTION ! Signale des risques pouvant entraîner des blessures ou des risques pour la santé.



IMPORTANT. Signale des risques pouvant entraîner des dommages matériels ou des dysfonctionnements.



CONSEIL. Signale des informations contenant un conseil ou une remarque utile.

Explication des avertissements et des pictogrammes d'instruction



AVERTISSEMENT ! Le raccordement électrique doit être effectué par un personnel qualifié, formé et autorisé.



AVERTISSEMENT ! Le montage doit être effectué par un personnel qualifié, formé et autorisé.



AVERTISSEMENT ! Risque d'électrocution ! Ne travaillez jamais sous tension électrique.



AVERTISSEMENT! Respectez les instructions de montage supplémentaires (10315634; 10325558) pour le luminaire correspondant.

Utilisation conforme à l'usage prévu

Accessoires destinés à **AMATRIS G4 ...**



IT

Per la propria sicurezza

Leggere con attenzione tutti gli avvisi e le descrizioni delle varie fasi della procedura di montaggio. Conservare le istruzioni per poterle consultare al momento di eseguire lavori di manutenzione e smontaggio.

Spiegazione dei livelli di avvertenza

Osservare e attenersi alle avvertenze. Una mancata osservanza delle avvertenze può essere causa di lesioni o danni materiali!



AVVERTENZA! Mette in guardia dai pericoli che possono comportare lesioni gravi e/o mortali.



ATTENZIONE! Mette in guardia da pericoli che possono essere causa di lesioni o rischi per la salute.



AVVISO. Mette in guardia da pericoli che possono essere causa di danni materiali o disturbi di funzionamento.



SUGGERIMENTO. Indica informazioni comprendenti un consiglio o un avviso utile.

Spiegazione delle avvertenze e dei pittogrammi didattici



AVVERTENZA! Il collegamento elettrico deve essere eseguito da personale competente, addestrato e autorizzato.



AVVERTENZA! Il montaggio deve essere eseguito da personale competente, addestrato e autorizzato.



AVVERTENZA! Pericolo di scarica elettrica! Mai lavorare in presenza di tensione elettrica.



AVVERTENZA! Osservare le ulteriori istruzioni di installazione (10315634; 10325558) per l'apparecchio di illuminazione corrispondente.

Impiego secondo destinazione

Destinato all'impiego come accessorio per **AMATRIS G4 ...**



AMATRIS G4 SP

ES

Para su seguridad

Por favor, lea detenidamente todas las indicaciones y los pasos de montaje. Guarde las instrucciones para los trabajos de mantenimiento y desmontaje.

Explicación de los niveles de alerta

Por favor, tenga en cuenta y siga las indicaciones de peligro. ¡El incumplimiento de las indicaciones de peligro puede provocar lesiones o daños materiales!



¡ADVERTENCIA! Indica peligros que pueden provocar lesiones graves y/o mortales.



¡ATENCIÓN! Indica peligros que pueden provocar lesiones y riesgos de salud.



¡IMPORTANTE! Indica peligros que pueden provocar daños materiales o fallos de funcionamiento.



CONSEJO. Indica información con un consejo o una pista útil.

Explicación de las advertencias y los pictogramas de instrucción



¡ADVERTENCIA! La conexión eléctrica debe ser realizada por personal profesional, formado y autorizado.



¡ADVERTENCIA! El montaje debe ser realizado por personal profesional, formado y autorizado.



¡ADVERTENCIA! ¡Riesgo de choque eléctrico! Nunca realice trabajos si esta tiene tensión eléctrica.



¡ADVERTENCIA! Tenga en cuenta la instrucción del montaje adicional (**10315634; 10325558**) de la luminaria correspondiente.

Uso previsto

Como accesorio para **AMATRIS G4 ...**

NL

Voor uw veiligheid

Lees alle aanwijzingen en montageschappen zorgvuldig. Bewaar de handleiding voor latere onderhouds- of demontagewerkzaamheden.

Verklaring van de waarschuwningsniveaus

Neem de waarschuwingen in acht en volg de instructies. Bij niet-naleving kan letsel of materiële schade het gevolg zijn!



WAARSCHUWING! Wijst op gevaren die zware en/of dodelijke letsels tot gevolg kunnen hebben.



VOORZICHTIG! Wijst op gevaren die kunnen leiden tot letsels of gezondheidsrisico's.



BELANGRIJK. Wijst op gevaren die kunnen leiden tot materiële schade of functionele storingen.



TIP. Wijst op informatie die een advies of een nuttige aanwijzing bevat.

Verklaring van waarschuwingen en instructiepictogrammen



WAARSCHUWING! De elektrische aansluiting moet worden uitgevoerd door bevoegd en opgeleid personeel.



WAARSCHUWING! De montage moet worden uitgevoerd door bevoegd en opgeleid personeel.



WAARSCHUWING! Gevaar voor een elektrische schok! Werk nooit terwijl deze onder elektrische spanning staat.



WAARSCHUWING! Neem de aanvullende montagehandleiding (**10315634; 10325558**) voor de betreffende armatuur.

Bedoeld gebruik

Bedoeld als toebehoren voor **AMATRIS G4 ...**

AMATRIS G4 SP

PL

Zasady bezpieczeństwa

Należy uważnie przeczytać wszystkie instrukcje i czynności montażowe. Zachować instrukcję na wypadek konserwacji lub demontażu.

Wyjaśnienie poziomów ostrzegania

Przestrzegać wskazówek ostrzegawczych. Nieprzestrzeganie wskazówek ostrzegawczych może spowodować obrażenia ciała lub szkody rzeczowe!



OSTRZEŻENIE! Oznacza zagrożenia, które mogą prowadzić do poważnych i/lub śmiertelnych obrażeń ciała.



UWAGA! Oznacza zagrożenia, które mogą prowadzić do obrażeń ciała lub zagrożenia dla zdrowia.



WSKAZÓWKA. Oznacza zagrożenia, które mogą prowadzić do szkód materialnych lub nieprawidłowego działania.



PORADA. Oznacza informacje, które zawierają poradę lub przydatną wskazówkę.

Objaśnienie ostrzeżeń i piktogramów instruktażowych



OSTRZEŻENIE! Podłączenie elektryczne musi być wykonane przez kompetentny personel, który został przeszkolony i posiada odpowiednie uprawnienia.



OSTRZEŻENIE! Montaż musi być przeprowadzony przez kompetentny personel, który został przeszkolony i posiada odpowiednie uprawnienia.



OSTRZEŻENIE! Niebezpieczeństwo porażenia prądem elektrycznym! Nigdy nie pracować pod napięcie elektryczne.



OSTRZEŻENIE! Przestrzegać dodatkowa instrukcja montażu (**10315634; 10325558**) dla odpowiedniej oprawy.

Zastosowanie zgodnie z przeznaczeniem

Przeznaczone jako akcesorium do **AMATRIS G4 ...**





AMATRIS G4 SP

Type
AMATRIS G4 C04 SP 140 ...

~ kg
0,5

A

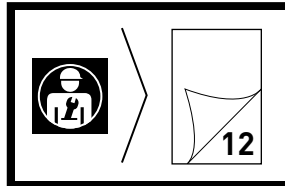
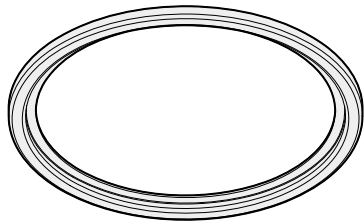

i

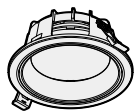

AMATRIS G4 C04 SP 140 ...

AMATRIS G4 C04 ...

AMATRIS G4 SP



Type
AMATRIS G4 C04 SP 140 ...

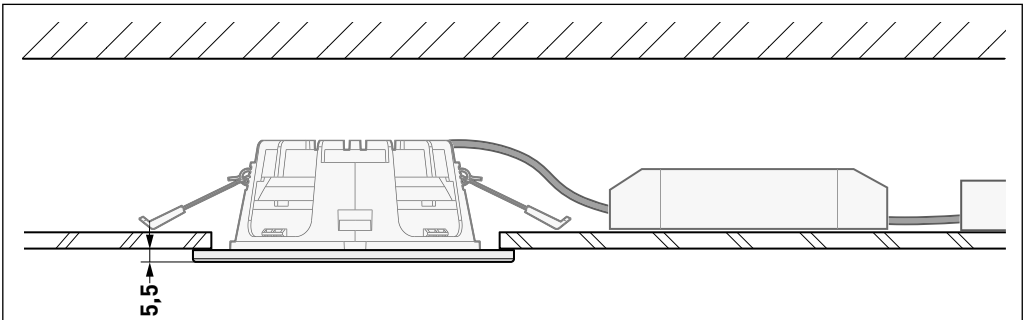

5,5

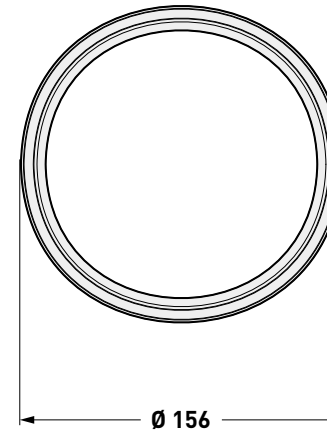

Ø 156

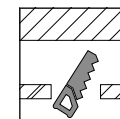

min. Ø 121⁺²
max. Ø 140⁺²

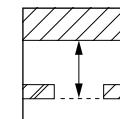

min. 70





AMATRIS G4 SP

Type	≈ kg
AMATRIS G4 C04 SP 220 ...	0,8
AMATRIS G4 C04 SP 260 ...	1,2
AMATRIS G4 C07 SP 280 ...	0,8

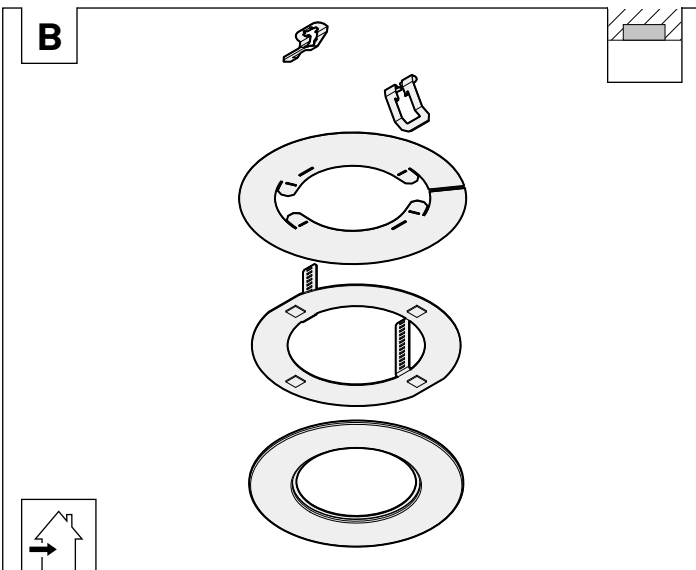

i

AMATRIS G4 C04 SP 220 ...	AMATRIS G4 C04 ...
AMATRIS G4 C04 SP 260 ...	AMATRIS G4 C04 ...
AMATRIS G4 C07 SP 280 ...	AMATRIS G4 C07 ...

AMATRIS G4 SP



Type
AMATRIS G4 C04 SP 220 ...
AMATRIS G4 C04 SP 260 ...
AMATRIS G4 C07 SP 280 ...

← Ø 250 ... SP 220 ... →
 ← Ø 300 ... SP 260 ... →
 ← Ø 330 ... SP 280 ... →

← Ø 236 ... SP 220 ... →
 ← Ø 276 ... SP 260 ... →
 ← Ø 296 ... SP 280 ... →

min. 80 ... SP 220 ...
 min. 80 ... SP 260 ...
 min. 105 ... SP 280 ...

min. Ø 150⁺²
 max. Ø 260⁺² ... SP 260 ...

min. Ø 150⁺²
 max. Ø 220⁺² ... SP 220 ...

min. Ø 240⁺²
 max. Ø 280⁺² ... SP 280 ...

mm



AMATRIS G4 SP

01

B

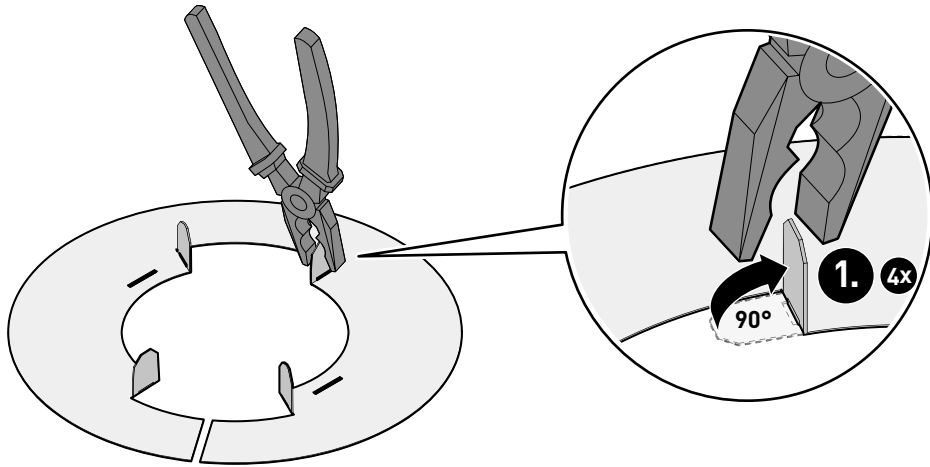

02

B

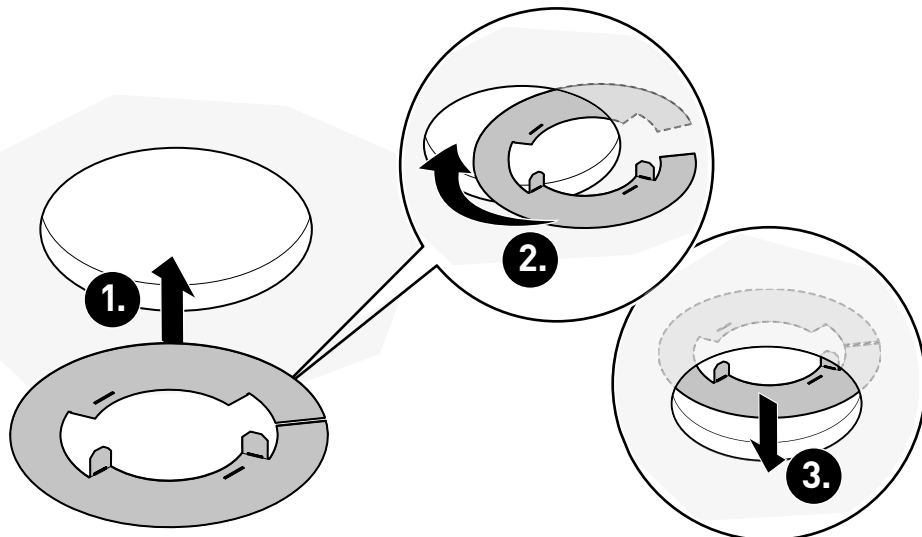

03

B

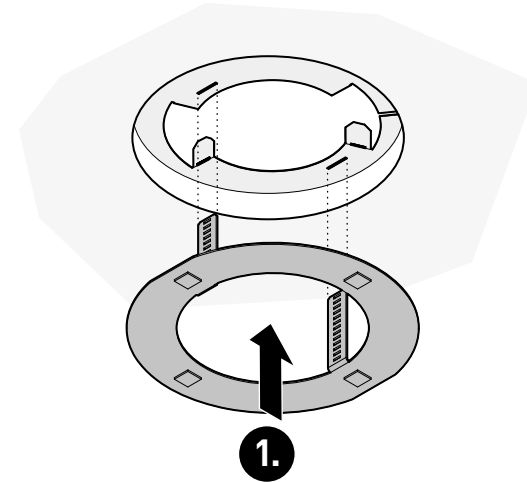

04

B

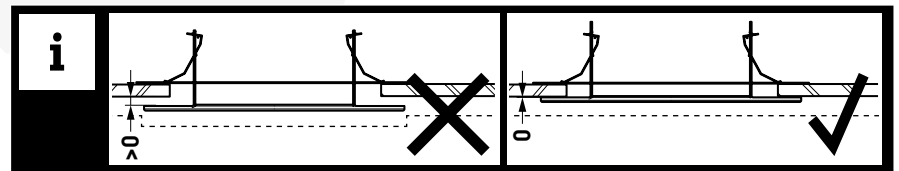
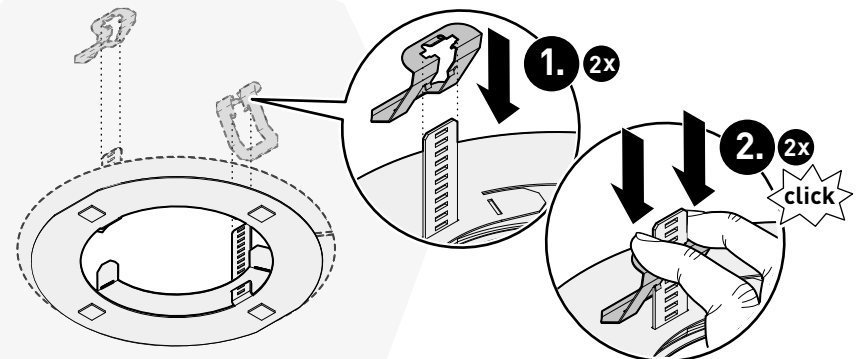

AMATRIS G4 SP



AMATRIS G4 SP

05

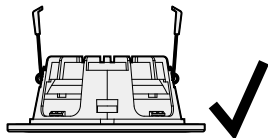
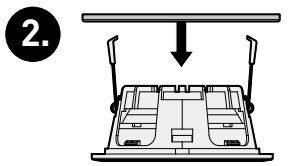
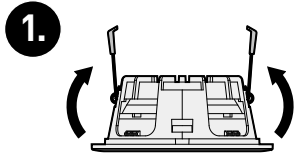
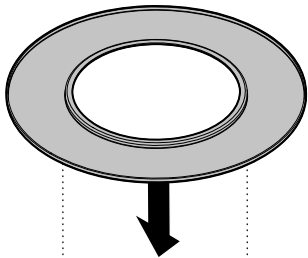

06

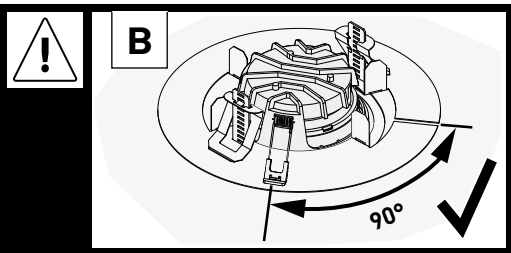
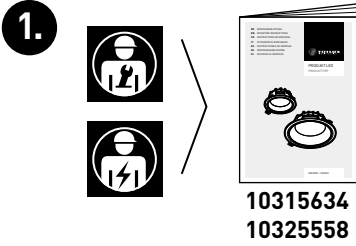
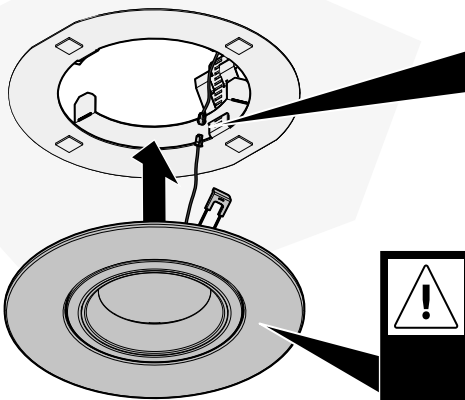

AMATRIS G4 SP

07

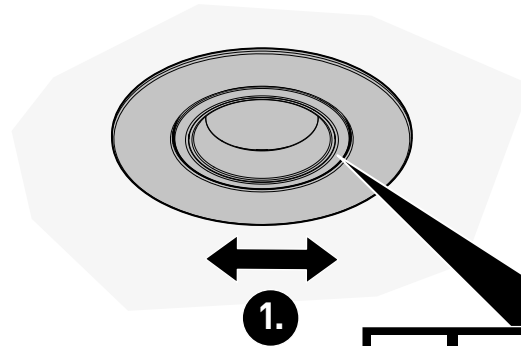

1.

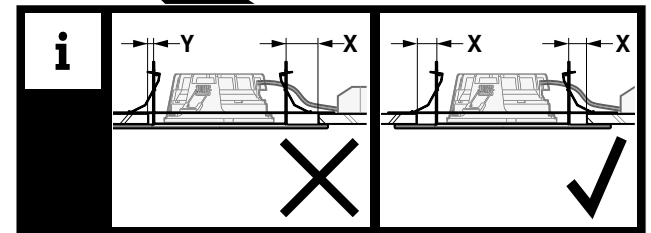

01

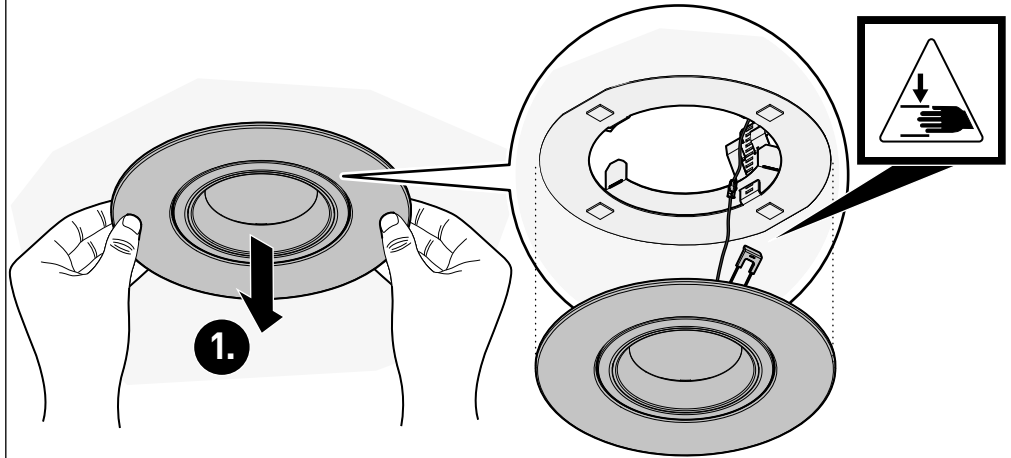

1.





02

B

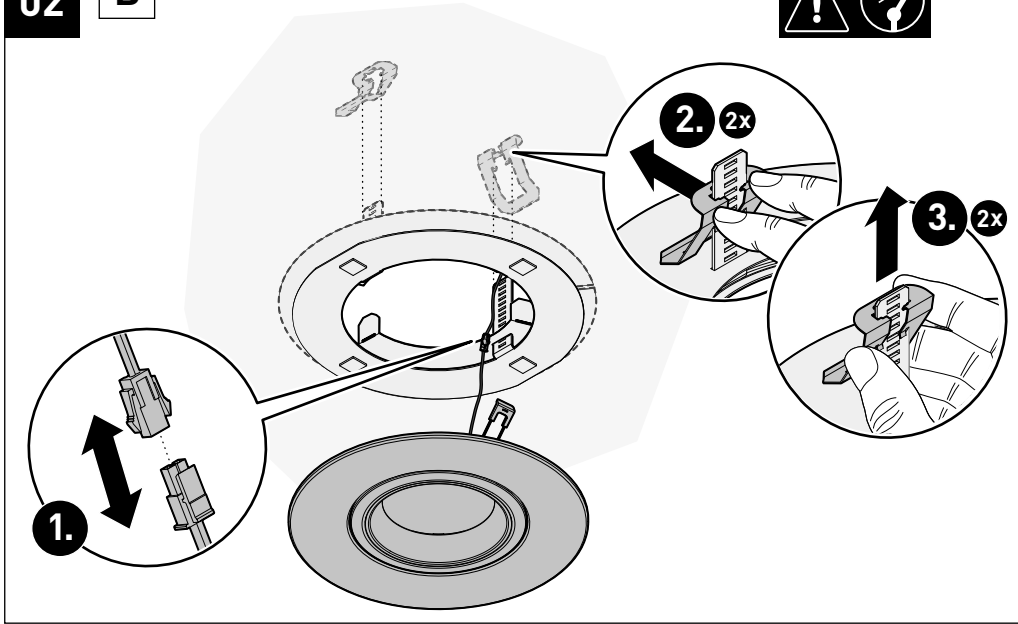

TRILUX GmbH & Co. KG

Heidestraße
D-59759 Arnsberg
+49 2932 301-0
info@trilux.com
www.trilux.com