

# INSTRUCTION MANUAL

## A121APPX, AL121APPX & MV121 APPELLO

### Alarm Tone and Voice Annunciation Sounder

### 1) Introduction

The Appello tone and speech annunciation sounder has three different styles in AC and DC.

- A121APPX & MV121 Sounder
  - AL121APPX Sounder-Beacon Combination
- Sounder-Beacon Combination units are available as either a high output LED or Xenon strobe.

These Sounder units share a common set of functions:-

- 4 stages, each stage can record up to 30 seconds of CD quality audio.
- Facility to record via an on board microphone or a line in input.
- The recorded message can be played back proceeded either with or without the choice of one of forty five tones.

The Beacon functions are either:-

- Xenon Strobe - 1Hz flash rate
- LED - Either Steady or 2Hz blink rate

### 2) Operating and Marking

All units have the following operating requirements and limitations.

Unit Type No.	Voltage	Range	Current
Sounder only outputs			
A121APPX DC & MV121 DC	24Vdc	14-30Vdc	1.51A
	Max Current 1.85A @ 30Vdc		
A121APPX AC & MV121 AC	115Vac	90-260Vac	542mA
	230Vac	90-260Vac	517mA
	Max Current 668mA @ 90Vac		

AL121APPX combined unit - Add selected sounder & beacon currents to calculate total current required.

		Beacon only outputs	
LED Beacon DC	24Vdc	10-30Vdc	157mA
	Max Current 166mA @ 30Vdc		
LED Beacon AC	115Vac	90-260Vac	60mA
	230Vac	90-260Vac	35mA
	Max Current 60mA @ 90Vac		
Xenon Beacon DC	12Vdc	10-14Vdc	500mA
	24Vdc	20-28Vdc	250mA
Xenon Beacon AC	115Vac	+/-10%Vac	100mA
	230Vac	+/-10%Vac	50mA

Operating Temp: -20 to +55°C

All units IP Rating: Type 4 / 4X / 3R / 13 , IP66  
MV121 additional IP Rating: IP67

Marking:



### 3) Installation & Wiring Requirements

A121APPX

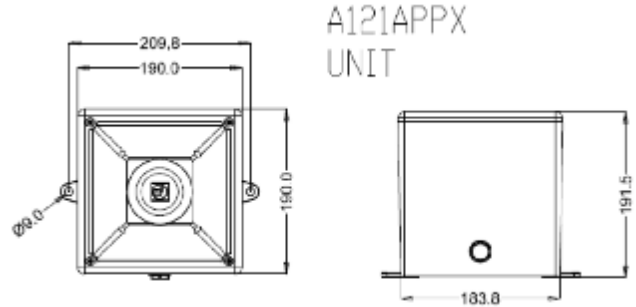

AL121APPX

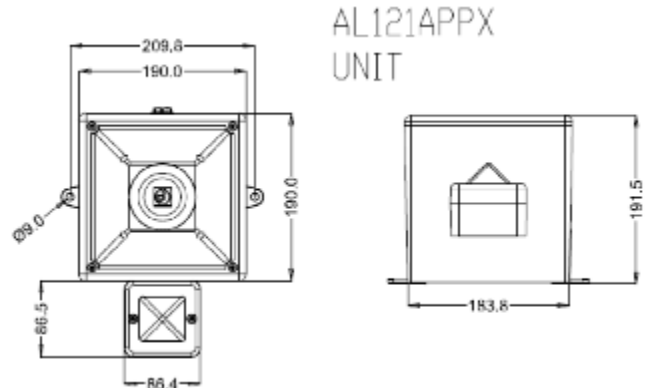

MV121

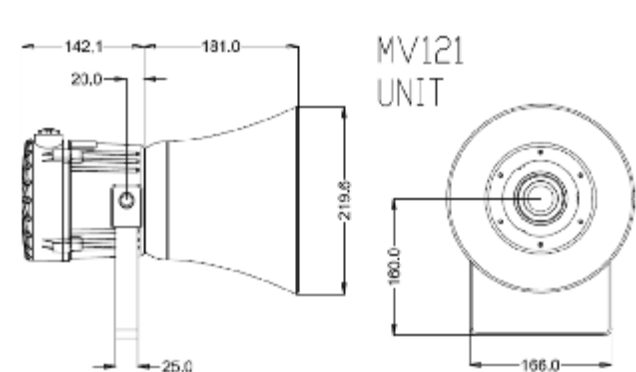

Always de-energize unit before removing cover.  
 The installation of the units must be in accordance with any local codes that may apply and should only be carried out by a competent trained electrical engineer.  
 The power terminals on the control unit are clearly marked and will accept up to 1.5mm<sup>2</sup> cable.

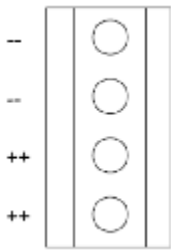

DC Terminals  
 on main PCB.  
 ++ = Positive  
 -- = Negative



AC Terminals  
 On Sub PCB  
 L = Live  
 N = Neutral  
 E = Earth

The AL121 units will have the beacon already prewired to the unit so no extra wiring is required.

#### 4) Beacon Set-up

The beacon unit may need to be configured dependant on the type of flash required.

The xenon beacon has a 1Hz flash rate only.

The LED beacon is set as standard to the 2Hz flash mode but it can be set to a steady on mode also. To alter the settings, change the position of the header pin as shown.

- Remove header for steady mode.
- Keep header in standard position for 2Hz flashing mode

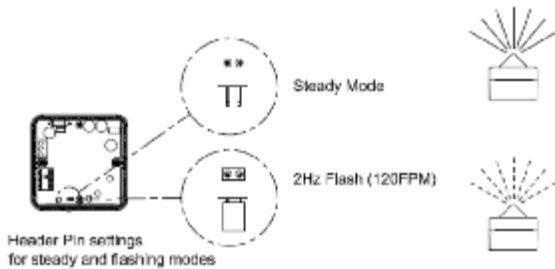

#### 5) Unit Set-up and Recording

The unit will need to be configured to suit the end user.

If recording either via the onboard microphone or the in-line connector the unit will need to be supplied with power.

DC units can be powered when completing recording and set-up.

**Warning! : During set-up on AC units care must be taken not to touch the live terminals. This is because on the AC units there is a risk of electric shock.**

See section 7) Appello Setup Guide overleaf for Set-up instructions and functions.

#### 6) Tone Selection Table

The Appello unit has 45 different tones (See Table 1) that can be selected for the first stage alarm. The systems can then be switched to sound second, third and fourth stage alarm tones. The tones are selected by operation of a DIP switch S4 on the main PCB.

The tone table (Table 1) shows the switch positions for the 45 tones and which tones are available for the second third and fourth stages.

#### Example

**S4 Dip Switch -  
 Shown Set for Tone 1**  
 (All switches OFF)



To sound stage one simply connect the supply voltage (+ve and -ve) for DC units and (L, N, E) for AC units, to the supply input terminals on the correct PCB shown.

DC Units Second, Third and Fourth Stage Selection

The Appello unit uses –ve switching to change the tone to the second, third and fourth stages.

**Warning! : The negative supply must remain connected to the -(ve) terminal and a link made from this to the appropriate stage (S2) terminal otherwise the unit will be damaged.**

To change to the second, third or fourth stage tone, link the -ve supply line to terminal relevant stage terminal. I.e. for Stage 2 link the -ve supply line to the S2 terminal, for Stage 3 link the -ve supply to the S3 terminal etc.

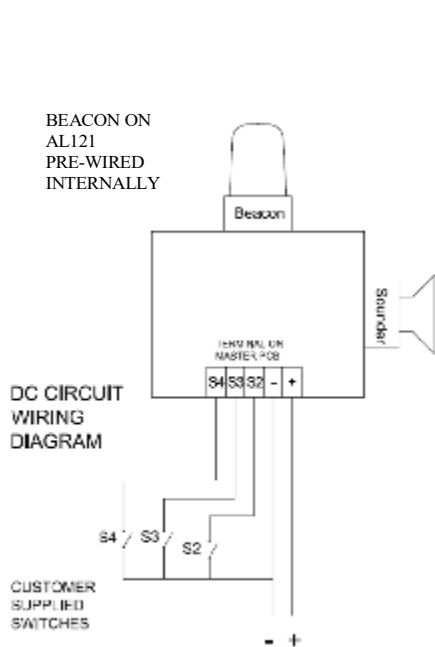

AC Units Second, Third and Fourth Stage Selection

The Appello unit uses Live switching to change the tone to the second, third and fourth stages.

To change to the second, third or fourth stage tone, whilst maintaining the ac supply to the Live and neutral, also link the Live supply line to terminal relevant stage terminal. I.e. for Stage 2 link the Live supply to the S2 terminal, for Stage 3 link the Live supply to the S3 terminal etc.

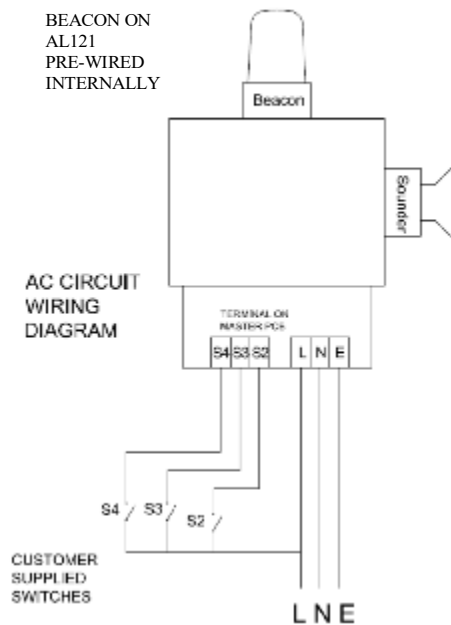

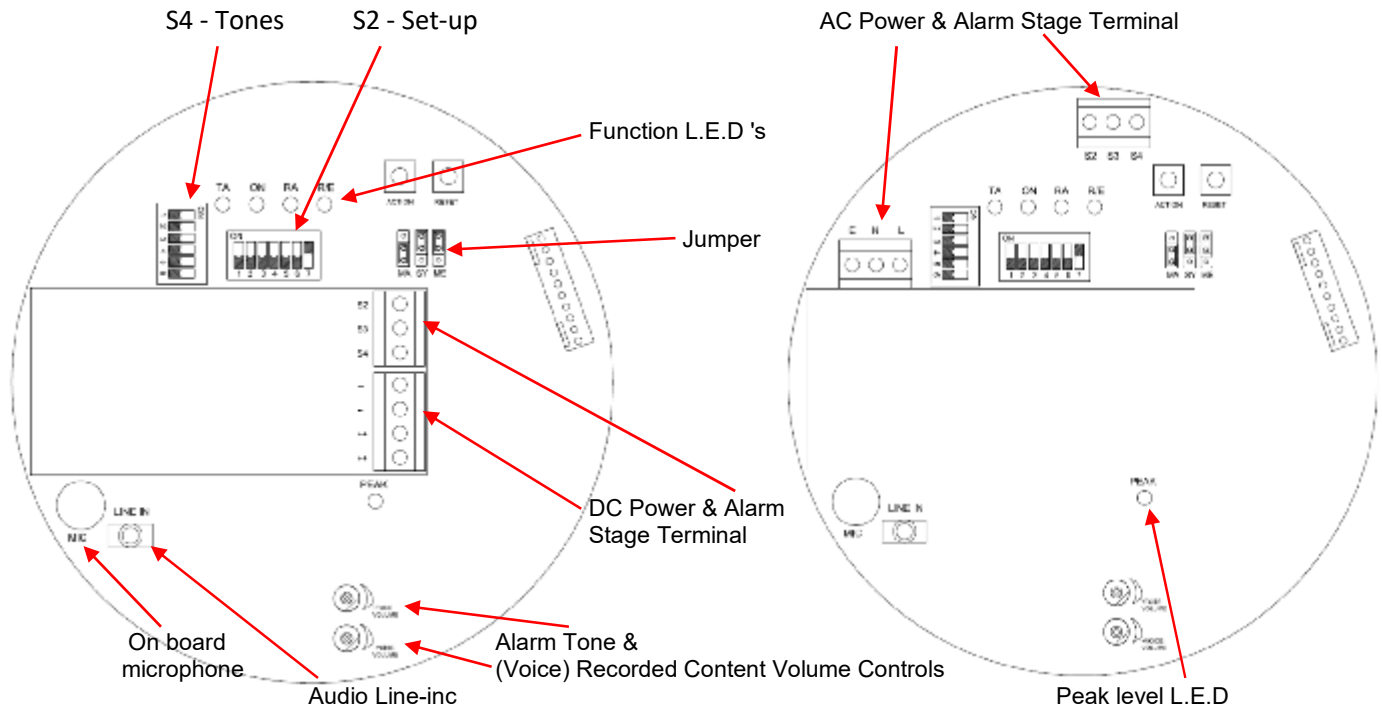

DC A121APPX, MV121 & AL121APPX Board

AC A121APPX, MV121 & AL121APPX Board

## 7) Appello Setup Guide

The following guide is designed to get the user quickly interfacing with the Appello unit.

- The Appello unit can be set-up to either play an attention seeking tone and then a recorded message or just play the recorded message.
- The user can:
  - Record on each of the 4 stages using either the Line In or Microphone inputs
  - Select the required alarm tone
  - Delete unwanted messages.
- To re-record a message on a particular stage, the previous message on that stage must be deleted first.
- Once the user has configured the unit, it must be put into it's Playback Mode and S2 switches set to stage 1, as shown in Quick Ref - Playback Mode (Stage 1 illustrated) guide below.
- The "Mass Erase" function will erase all the recorded stages.
- **The "Mass Erase" can also be used to reset the unit if any functionality is lost.**











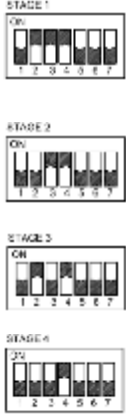

**Quick ref - Switch 'S2' Dip Switch Function Settings**

Switch No.	OFF Position Function		ON Position Function
1	Record Mode		Playback Mode
2	Stage selection switch		Switch 2 On & Switch 3 On = Alarm Stage 1 Switch 2 Off & Switch 3 On = Alarm Stage 2 Switch 2 On & Switch 3 Off = Alarm Stage 3 Switch 2 Off & Switch 3 Off = Alarm Stage 4
3	Stage selection switch		On board Microphone selected
4	Line-In selected		Playback – Record & Erase Mode OFF
5	Program – Record & Erase Mode ON		Message only Playback
6	Message & Tone Playback		Single Message or Mass Erase Mode ON
7	Single Message or Mass Erase Mode OFF		



**Quick Ref - Playback Mode (Stage 1 illustrated)**

1	<p>For Stage 1: Set Switch 'S2' positions 1,2,3 &amp; 5 to 'ON'</p> <p>Alternatively for :</p> <p>For Stage 2: Set Switch 'S2' positions 1,3 &amp; 5 to 'ON'</p> <p>For Stage 3: Set Switch 'S2' positions 1,2 &amp; 5 to 'ON'</p> <p>For Stage 4: Set Switch 'S2' positions 1 &amp; 5 to 'ON'</p>		
2	Switch on power or Press reset button		
3a	Unit will sound alarm tone and then recorded content repeatedly		

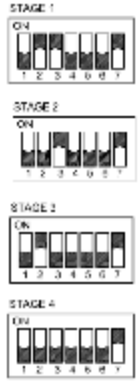

**Quick Ref - Recording Mode (Stage 1 illustrated)**

1	<p>For Stage 1: Set Switch 'S2' positions 2,3 &amp; 4 to 'ON'</p> <p>Alternatively for :</p> <p>For Stage 2: Set Switch 'S2' positions 3 &amp; 4 to 'ON'</p> <p>For Stage 3: Set Switch 'S2' positions 2 &amp; 4 to 'ON'</p> <p>For Stage 4: Set Switch 'S2' position 4 to 'ON'</p> <p>To record from Line-in instead of the on board microphone follow above step 1 but set Switch 'S2' position 4 to OFF</p>	 <p>STAGE 1 S1: [Switches 1-7] S2: [Switches 2,3,4]</p> <p>STAGE 2 S1: [Switches 1-7] S2: [Switches 3,4]</p> <p>STAGE 3 S1: [Switches 1-7] S2: [Switches 2,4]</p> <p>STAGE 4 S1: [Switches 1-7] S2: [Switch 4]</p>	<p>TA ON RA R/E</p> <p>○ ○ ○ ○</p>
2	<p>Switch on power or Press reset button</p>		<p>TA ON RA R/E</p> <p>○ ○  ○</p>
3a	<p>Press action button: Start recording</p>		<p>TA ON RA R/E</p> <p>○   </p>
3b	<p>Speak into microphone or plug line-in.</p> <p>It is suggested that a 5cm gap is maintained to the microphone.</p> <p>The peak detector L.E.D should flash regularly to maintain a good recording level. However, if it stays on for most of the time, the recording may be distorted.</p>		<p>TA ON RA R/E</p> <p>○   ○</p> <p><b>PEAK</b></p> <p></p>
4	<p>Press action button: Stop recording</p>		<p>TA ON RA R/E</p> <p>○ ○  ○</p>

**Quick Ref - Erase Single stage Mode (Stage 1 illustrated)**



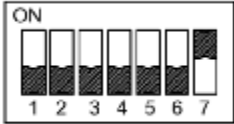
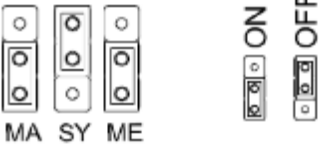

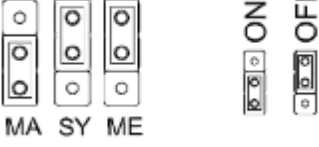

1	<p>For Stage 1: Set Switch 'S2' positions 2,3 &amp; 7 to 'ON'</p> <p>Alternatively for :</p> <p>For Stage 2: Set Switch 'S2' positions 3 &amp; 7 to 'ON'</p> <p>For Stage 3: Set Switch 'S2' positions 2 &amp; 7 to 'ON'</p> <p>For Stage 4: Set Switch 'S2' position 7 to 'ON'</p>		<p>TA    ON    RA    R/E</p> <p>○    ○    ○    ○</p>
2	<p>Switch on power or Press reset button</p>		<p>TA    ON    RA    R/E</p> <p>○    ○    ○    ○</p> <p>                    </p>
3a	<p>Press action button: Erase will begin</p>		<p>TA    ON    RA    R/E</p> <p>○    ○    ○    ○</p> <p>                             </p>
3b	<p>---- erase complete</p>		<p>TA    ON    RA    R/E</p> <p>○    ○    ○    ○</p> <p>                    </p>

**Quick Ref - Mass Erase Mode (Erases All Stages)**

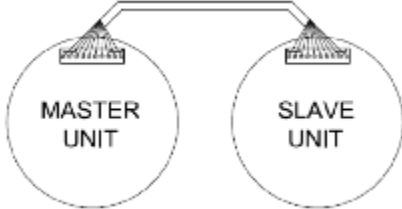
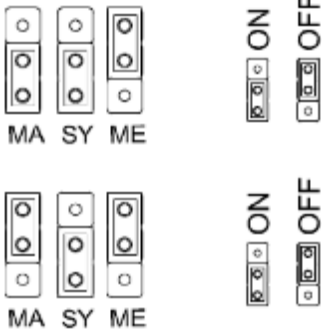
1	Set Switch 'S2' position 7 to 'ON'		<p>TA    ON    RA    R/E</p> <p>○    ○    ○    ○</p>
2	Set jumper 'ME' to ON position (centre and bottom pin connected)		
3	Switch on power or Press reset button		<p>TA    ON    RA    R/E</p> <p>○    ○    ○    ○</p> <p>-----</p>
4a	Press action button: Erase will begin		<p>TA    ON    RA    R/E</p> <p>○    ○    ○    ○</p> <p>-----</p>
4b	- - - - erase complete		<p>TA    ON    RA    R/E</p> <p>○    ○    ○    ○</p> <p>-----</p>
5	Reset Jumper 'ME' to OFF position		

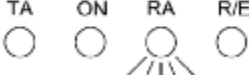

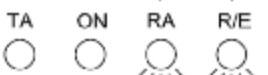
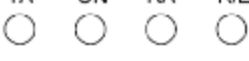
**Quick Ref - Synchronising Two Sounders (All stages)**

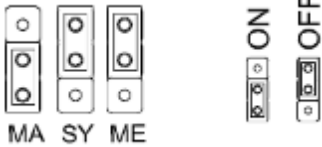
1	Connect Synch cable to Master and Slave PCB		
2	<p>Set 1 off Units as Master and 1 off Unit as Slave Set jumper to SY on</p> <p>Set jumper MA on Master unit to master position (on)</p> <p>Set jumper MA on Slave unit to slave position (off)</p> <p>Position of S2 switch does not affect synch operation.</p>		<p>TA ON RA R/E</p> 
3	<p>Switch on power onto the Master unit first</p> <p>Then switch power onto the Slave unit</p>	<p>Master Unit</p> <p>Slave Unit</p>	<p>TA ON RA R/E</p>  <p>TA ON RA R/E</p> 
4a	Press action button on the Master Unit: Synchronisation will begin (Duration 13 Minutes)	 <p>Master Unit</p> <p>Slave Unit</p>	<p>TA ON RA R/E</p>  <p>TA ON RA R/E</p> 
4b	<p>---- Synchronisation complete</p> <p>Switch off Power to units</p>	<p>Master Unit</p> <p>Slave Unit</p>	<p>TA ON RA R/E</p>  <p>TA ON RA R/E</p> 
5	<p>Reset on both units jumper SY to off</p> <p>Set jumper MA on both units to Master position (on)</p>		

### Table 1: Tone selection table

Stage 1	Frequency Description		Switch						Stage 2	Stage 3	Stage 4
			1	2	3	4	5	6	(S2)	(S3)	(S4)
Tone 1	340 Hz Continuous								Tone 2	Tone 5	Tone 29
Tone 2	800/1000Hz @ 0.25 sec Alternating		■						Tone 17	Tone 5	Tone 29
Tone 3	500/1200Hz @ 0.3Hz 0.5 sec Slow Whoop		■	■					Tone 2	Tone 5	Tone 29
Tone 4	800/1000Hz @ 1Hz Sweeping		■	■					Tone 6	Tone 5	Tone 29
Tone 5	2400Hz Continuous					■			Tone 3	Tone 20	Tone 29
Tone 6	2400/2900Hz @ 7Hz Sweeping		■		■				Tone 7	Tone 5	Tone 29
Tone 7	2400/2900Hz @ 1Hz Sweeping			■	■				Tone 10	Tone 5	Tone 29
Tone 8	500/1200/500Hz @ 0.3Hz Sweeping		■	■	■				Tone 2	Tone 5	Tone 29
Tone 9	1200/500Hz @ 1Hz - DIN / PFEER P.T.A.P.						■		Tone 15	Tone 2	Tone 29
Tone 10	2400/2900Hz @ 2Hz Alternating		■			■			Tone 7	Tone 5	Tone 29
Tone 11	1000Hz @ 1Hz Intermittent			■		■			Tone 2	Tone 5	Tone 29
Tone 12	800/1000Hz @ 0.875Hz Alternating		■	■		■			Tone 4	Tone 5	Tone 29
Tone 13	2400Hz @ 1Hz Intermittent				■	■			Tone 15	Tone 5	Tone 29
Tone 14	800Hz 0.25sec on, 1 sec off Intermittent		■		■	■			Tone 4	Tone 5	Tone 29
Tone 15	800Hz Continuous			■	■	■			Tone 2	Tone 5	Tone 29
Tone 16	660Hz 150mS on, 150mS off Intermittent		■	■	■	■			Tone 18	Tone 5	Tone 29
Tone 17	544Hz (100mS)/440Hz (400mS) - NF S 32-001						■		Tone 2	Tone 27	Tone 29
Tone 18	660Hz 1.8sec on, 1.8sec off Intermittent		■				■		Tone 2	Tone 5	Tone 29
Tone 19	1.4KHz-1.6KHz 1s, 1.6KHz-1.4KHz 0.5s -NFC48-265			■			■		Tone 2	Tone 5	Tone 29
Tone 20	660Hz Continuous		■	■			■		Tone 2	Tone 5	Tone 29
Tone 21	554Hz/440Hz @ 1Hz Alternating				■	■			Tone 2	Tone 5	Tone 29
Tone 22	544Hz @ 0.875 sec. Intermittent		■		■	■			Tone 2	Tone 5	Tone 29
Tone 23	800Hz @ 2Hz Intermittent			■	■		■		Tone 6	Tone 5	Tone 29
Tone 24	800/1000Hz @ 50Hz Sweeping		■	■	■		■		Tone 29	Tone 5	Tone 29
Tone 25	2400/2900Hz @ 50Hz Sweeping					■	■		Tone 29	Tone 5	Tone 29
Tone 26	Bell		■			■	■		Tone 2	Tone 15	Tone 29
Tone 27	554Hz Continuous			■		■	■		Tone 26	Tone 5	Tone 29
Tone 28	440Hz Continuous		■	■		■	■		Tone 2	Tone 5	Tone 29
Tone 29	800/1000Hz @ 7Hz Sweeping				■	■	■		Tone 7	Tone 5	Tone 29
Tone 30	300Hz Continuous		■		■	■	■		Tone 2	Tone 5	Tone 29
Tone 31	660/1200Hz @ 1Hz Sweeping			■	■	■	■		Tone 26	Tone 5	Tone 29
Tone 32	Two tone chime.		■	■	■	■	■		Tone 26	Tone 15	Tone 29
Tone 33	745Hz @ 1Hz Intermittent						■		Tone 2	Tone 5	Tone 29
Tone 34	1000 & 2000Hz @ 0.5 sec Alternating - Singapore		■				■		Tone 38	Tone 45	Tone 29
Tone 35	420Hz @ 0.625 sec Australian Alert			■			■		Tone 36	Tone 5	Tone 29
Tone 36	500-1200Hz 3.75sec /0.25sec. Australian Evac.		■	■			■		Tone 35	Tone 5	Tone 29
Tone 37	1000Hz Continuous - PFEER Toxic Gas				■		■		Tone 9	Tone 45	Tone 29
Tone 38	2000Hz Continuous		■		■		■		Tone 34	Tone 45	Tone 29
Tone 39	800Hz 0.25sec on, 1 sec off Intermittent			■	■		■		Tone 23	Tone 17	Tone 29
Tone 40	544Hz (100mS)/440Hz (400mS) - NF S 32-001		■	■	■		■		Tone 31	Tone 27	Tone 29
Tone 41	Motor Siren - slow rise to 1200 Hz						■	■	Tone 2	Tone 5	Tone 29
Tone 42	Motor Siren - slow rise to 800 Hz		■				■	■	Tone 2	Tone 5	Tone 29
Tone 43	1200 Hz Continuous			■			■	■	Tone 2	Tone 5	Tone 29
Tone 44	Motor Siren - slow rise to 2400 Hz		■	■			■	■	Tone 2	Tone 5	Tone 29
Tone 45	1KHz 1s on, 1s off Intermittent - PFEER Gen. Alarm				■	■	■		Tone 38	Tone 34	Tone 29