

22260648	<b>DATA SHEET</b>	
Valid from: 12.09.2019	<b>AB-C5-M12MA-PG9</b>	

## Product description

Sensor/Actuator connector, angled plug, 5-pos., M12, A-coded, screw connection, metal knurl, cable screw connection Pg9



## General properties

Ambient temperature	-40 to +85 °C
Protection degree	IP 67
Number of contacts	5
Outer diameter, cable	6.0 – 8.0 mm
Termination type	screw connection
Termination cross section, AWG	24 – 18
Termination cross section, mm <sup>2</sup>	0.25 – 0.75
Mating cycles	≥ 100

## Electrical properties

Rated voltage	60 V
Contact resistance	≤ 8mΩ
Insulation resistance	≥ 100 MΩ
Proof voltage, contact-contact	≥ 1.0 kV
Proof voltage, contact-housing	≥ 1.0 kV
Rated current	4 A
Overvoltage category	II
Pollution degree	3

## Materials

Contact carrier	PA
Contact carrier, Inflammability class in accordance with UL 94	V0
Contacts, base material	CuZn
Contacts, surface	CuSnZn
Locking nut	Die-cast zinc, Ni plated
Grip body	PA
Sealing	NBR / FKM

## Standards

Product standard	M12-Connector acc. to DIN EN 61076-2-101
------------------	--

Creator: MANA2/PDP Released: IVSE1/PDP	Document: DB22260648EN Version: 05	Page 1 of 2
---	---------------------------------------	-------------

22260648	<b>DATA SHEET</b>	
Valid from: 12.09.2019	AB-C5-M12MA-PG9	

### Drawings

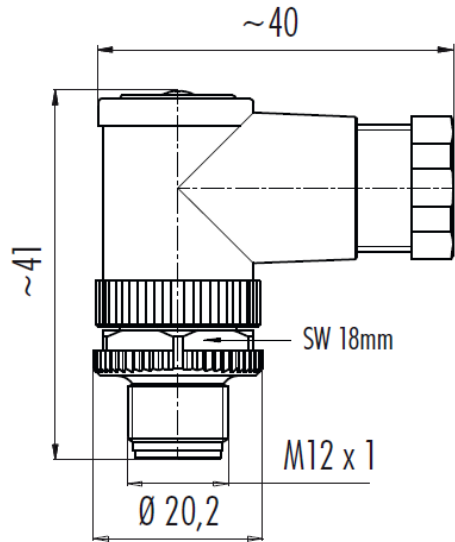

### Pin assignment

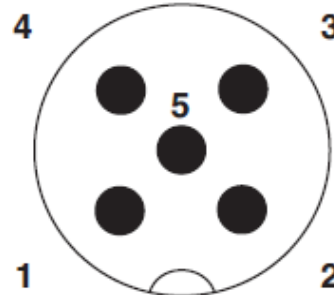

### Assembly instruction

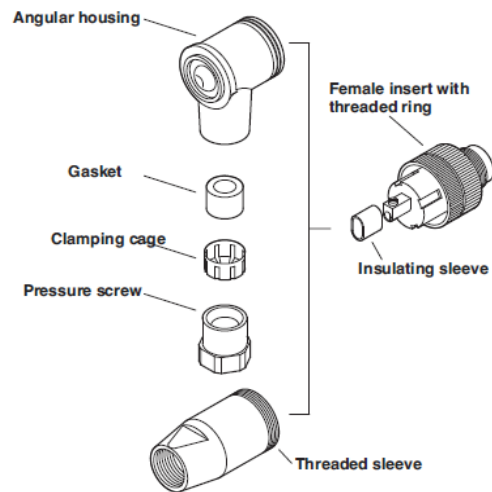

### Application range

Automation, industrial machinery and plant engineering

### Note

Photographs are not true to scale and do not represent detailed images of the respective products.

Creator: MANA2/PDP Released: IVSE1/PDP	Document: DB22260648EN Version: 05	Page 2 of 2
---	---------------------------------------	-------------