



PSN01-3501

deTem

SAFETY MULTIBEAM SENSORS

SICK
Sensor Intelligence.



Ordering information

deTem4 A/P

Scanning range	Number of beams	Beam separation	System part	Type	Part no.
8 m	2	500 mm	Passive unit	PSN01-3501	1103066

Other models and accessories → www.sick.com/deTem



Detailed technical data

Features

Application	Normal industrial environment
Functional principle	Active/passive
System part	Passive unit
Type of diversion	Prism deflection
Scanning range category	Great scanning range
Scanning range	8 m
Dimension of the light path	Typical 0.5 m ... 8 m
Number of beams	2
Beam separation	500 mm
Items supplied	Passive unit

Mechanical data

Dimensions	See dimensional drawing
Housing cross-section	38.9 mm x 43.7 mm
Material	Housing PMMA
Weight	+ 575 g (± 50 g)

Ambient data

Ambient operating temperature	-30 °C ... +55 °C
Storage temperature	-30 °C ... +70 °C
Air humidity	15 % ... 95 %, Non-condensing
Vibration resistance	5 g, 10 Hz ... 55 Hz (IEC 60068-2-6)
Shock resistance	10 g, 16 ms (IEC 60068-2-27)

Classifications

eCl@ss 5.0	27272703
-------------------	----------

eCl@ss 5.1.4	27272703
eCl@ss 6.0	27272703
eCl@ss 6.2	27272703
eCl@ss 7.0	27272703
eCl@ss 8.0	27272703
eCl@ss 8.1	27272703
eCl@ss 9.0	27272703
eCl@ss 10.0	27272703
eCl@ss 11.0	27272703
eCl@ss 12.0	27272703
ETIM 5.0	EC001832
ETIM 6.0	EC001832
ETIM 7.0	EC001832
ETIM 8.0	EC001832
UNSPSC 16.0901	46171620

Dimensional drawing (Dimensions in mm (inch))



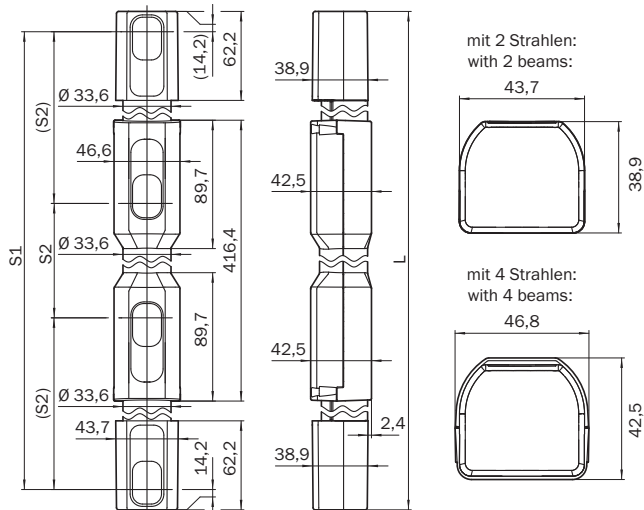



Passive unit for large sensing range (prism deflection)



Number of beams	Beam separation S1	Beam separation S2	L
2	500	-	528,4
4	-	300	928,4

Recommended accessories

Other models and accessories → www.sick.com/deTem

	Brief description	Type	Part no.
Muting accessories			
	Sensor bracket G6 and P250	BEF-2KHAAKU1	2113145
	Universal holder for round steel arms and muting arms, for mounting sensors or reflectors	BEF-KHS-N01	2044953
	Muting arm bracket	Muting arm bracket	2106455
	Muting arm, long	Muting arm, long	2111923
	Muting arm, short	Muting arm, short	2111924
Terminal and alignment brackets			
	4 pieces, FlexFix bracket for 2 devices (e.g. sender and receiver), can be aligned $\pm 15^\circ$, including M5 screw, plastic	BEF-1SHABPKU4	2066614
	4 pieces, QuickFix bracket for 2 devices (e.g. sender and receiver), plastic	BEF-3SHABPKU4	2098710

SICK AT A GLANCE

SICK is one of the leading manufacturers of intelligent sensors and sensor solutions for industrial applications. A unique range of products and services creates the perfect basis for controlling processes securely and efficiently, protecting individuals from accidents and preventing damage to the environment.

We have extensive experience in a wide range of industries and understand their processes and requirements. With intelligent sensors, we can deliver exactly what our customers need. In application centers in Europe, Asia and North America, system solutions are tested and optimized in accordance with customer specifications. All this makes us a reliable supplier and development partner.

Comprehensive services complete our offering: SICK LifeTime Services provide support throughout the machine life cycle and ensure safety and productivity.

For us, that is “Sensor Intelligence.”

WORLDWIDE PRESENCE:

Contacts and other locations –www.sick.com