



Mechanical features

Fixing

Front centre mounting

Auxiliary contact characteristics

Type of contact

1NO + 1NC

Dimensions

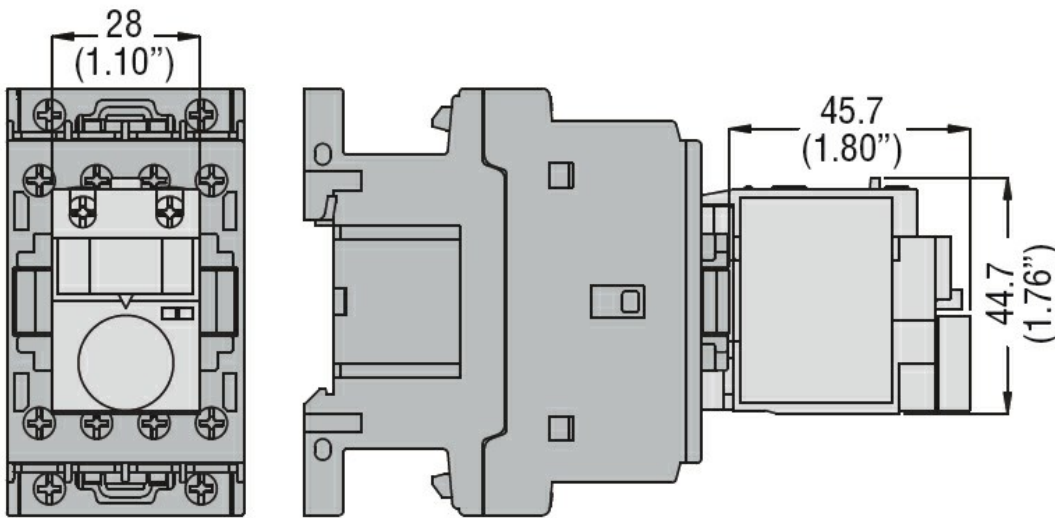

Wiring diagrams

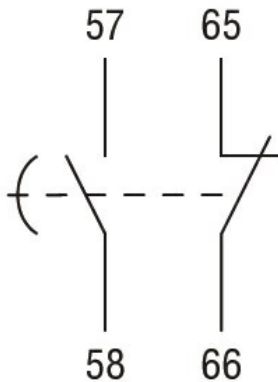

Certifications and compliance

Compliance

CSA C22.2 n° 60947-1

CSA C22.2 n° 60947-5-1

IEC/EN 60947-1

IEC/EN 60947-5-1

UL 60947-1

UL 60947-5-1

Certificates

CCC

DELAYED AUXILIARY CONTACT 1NO+1NC (PNEUMATIC OPERATION) ON ENERGISATION FOR FRONT CENTRE MOUNTING. SCREW TERMINALS, FOR BF... SERIES CONTACTORS, 6S

CSA

cURus

EAC

ETIM classification

ETIM 8.0

EC002498 -
Accessories/spare
parts for low-
voltage switch
technology