



# WTS16P-24161300CZZ

W16

SMALL PHOTOELECTRIC SENSORS

**SICK**  
Sensor Intelligence.



Illustration may differ



### Ordering information

| Type               | Part no. |
|--------------------|----------|
| WTS16P-24161300CZZ | 1111622  |

Other models and accessories → [www.sick.com/W16](http://www.sick.com/W16)

### Detailed technical data

#### Features

|   |   |
|---|---|
| <b>Functional principle</b>   | Photoelectric proximity sensor  |
| <b>Functional principle detail</b>  | Background suppression, TwinEye technology, MultiPulse                                |
| <b>Sensing range</b>  |   |
| Sensing range min.  | 50 mm   |
| Sensing range max.  | 750 mm  |
| Adjustable switching threshold for background suppression                                       | 100 mm ... 750 mm   |
| Reference object  | Object with 90% remission factor (complies with standard white according to DIN 5033) |
| Minimum distance between set sensing range and background (black 6% / white 90%)                | 50 mm, at a distance of 100 mm  |
| Recommended sensing range for the best performance  | 100 mm ... 300 mm   |
| <b>Emitted beam</b>   |   |
| Light source  | PinPoint LED  |
| Type of light   | Visible red light   |
| Shape of light spot   | Point-shaped  |
| Light spot size (distance)  | Ø 8 mm (300 mm)   |
| Maximum dispersion of the emitted beam around the standardized transmission axis (squint angle) | < +/- 1.0° (at Ta = +23 °C)   |

|                             |                        |   |
|-----------------------------|------------------------|---|
| <b>Key LED figures</b>      | Normative reference    | EN 62471:2008-09   IEC 62471:2006, modified   |
|                             | LED risk group marking | Free group  |
|                             | Wave length            | 635 nm  |
|                             | Average service life   | 100,000 h at $T_a = +25 \text{ °C}$   |
| <b>Adjustment</b>           | IO-Link                | For configuring the sensor parameters and Smart Task functions  |
| <b>Indication</b>           | LED blue               | BluePilot: sensing range indicator  |
|                             | LED yellow             | Status of received light beam<br>Static on: object present<br>Static off: object not present  |
| <b>Special features</b>     |                        | Factory setting: sensing range 205 mm<br>Dynamic blind zone 50 mm ... 75 mm<br>Factory setting: sensing range 205 mm<br>MultiPulse: sensor with self-monitoring |
| <b>Special applications</b> |                        | Detecting uneven, shiny objects, Detecting objects wrapped in film  |

### Safety-related parameters

|                                     |  |
|-------------------------------------|--|
| <b>MTTF<sub>D</sub></b>             | 419 years                                  |
| <b>DC<sub>avg</sub></b>             | 0%   |
| <b>T<sub>M</sub> (mission time)</b> | 20 years (EN ISO 13849, rate of use: 60 %) |

### Communication interface

|                             |  |
|-----------------------------|--|
| <b>IO-Link</b>              | ✓, V1.1  |
| Data transmission rate      | COM2 (38,4 kBaud)  |
| Cycle time                  | 2.3 ms   |
| Process data length         | 16 Bit   |
| Process data structure      | Bit 0 = switching signal $Q_{L1}$<br>Bit 1 = switching signal $Q_{L2}$<br>Bit 2 ... 15 = empty |
| VendorID                    | 26   |
| DeviceID HEX                | 0x800277   |
| DeviceID DEC                | 8389239  |
| Compatible master port type | A  |
| SIO mode support            | Yes  |

### Electrical data

|  |  |
|--|--|
| <b>Supply voltage <math>U_B</math></b> | 10 V DC ... 30 V DC <sup>1)</sup>                                      |
| <b>Ripple</b>                          | $\leq 5 V_{pp}$  |
| <b>Usage category</b>                  | DC-12 (According to EN 60947-5-2)<br>DC-13 (According to EN 60947-5-2) |
| <b>Current consumption</b>             | $\leq 30 \text{ mA}$ , without load. At $U_B = 24 \text{ V}$           |
| <b>Protection class</b>                | III  |

<sup>1)</sup> Limit values.

<sup>2)</sup> Signal transit time with resistive load in switching mode.

<sup>3)</sup> With light/dark ratio 1:1.

<sup>4)</sup> This switching output must not be connected to another output.

|                                       |   |
|---------------------------------------|---|
| <b>Digital output</b>                 |   |
| Number                                | 2 (Complementary)   |
| Type                                  | Push-pull: PNP/NPN  |
| Signal voltage PNP HIGH/LOW           | Approx. $U_B - 2.5 \text{ V} / 0 \text{ V}$   |
| Signal voltage NPN HIGH/LOW           | Approx. $U_B / < 2.5 \text{ V}$   |
| Output current $I_{\text{max}}$       | $\leq 100 \text{ mA}$   |
| Circuit protection outputs            | Reverse polarity protected<br>Overcurrent and short-circuit protected   |
| Response time                         | $\leq 0.1 \text{ s}^{2)}$   |
| Switching frequency                   | $10 \text{ Hz}^{3)}$  |
| <b>Pin/Wire assignment</b>            |   |
| Function of pin 4/black (BK)          | Digital output, object present → output $Q_{L1}$ , HIGH/LOW oscillating $10 \text{ Hz}$ ; IO-Link communication C <sup>4)</sup> |
| Function of pin 4/black (BK) – detail | The pin 4 function of the sensor can be configured, Additional possible settings via IO-Link                                    |
| Function of pin 2/white (WH)          | Digital output, object present → output $Q_{L1}$ , LOW/HIGH oscillating $10 \text{ Hz}^{4)}$                                    |
| Function of pin 2/white (WH) – detail | The pin 2 function of the sensor can be configured, Additional possible settings via IO-Link                                    |

<sup>1)</sup> Limit values.

<sup>2)</sup> Signal transit time with resistive load in switching mode.

<sup>3)</sup> With light/dark ratio 1:1.

<sup>4)</sup> This switching output must not be connected to another output.

### Mechanical data

|   |                           |
|---|---------------------------|
| <b>Housing</b>  | Rectangular               |
| <b>Dimensions (W x H x D)</b>                         | 20 mm x 55.7 mm x 42 mm   |
| <b>Connection</b>                                     | Male connector M12, 4-pin |
| <b>Material</b>                                       |                           |
| Housing   | Plastic, VISTAL®          |
| Front screen  | Plastic, PMMA             |
| Male connector  | Plastic, VISTAL®          |
| <b>Weight</b>   | Approx. 50 g              |
| <b>Maximum tightening torque of the fixing screws</b> | 1.3 Nm                    |

### Ambient data

|                                      |  |
|--------------------------------------|--|
| <b>Enclosure rating</b>              | IP66 (EN 60529)<br>IP67 (EN 60529)<br>IP69 (EN 60529) <sup>1)</sup>  |
| <b>Ambient operating temperature</b> | -40 °C ... +60 °C  |
| <b>Ambient temperature, storage</b>  | -40 °C ... +75 °C  |
| <b>Shock resistance</b>              | 50 g, 11 ms (25 positive and 25 negative shocks per axis, for X, Y, Z axes, 150 shocks in total (EN60068-2-27))<br>50 g, 6 ms (5,000 positive and 5,000 negative shocks per axis, for X, Y, Z axes, 30,000 shocks in total (EN60068-2-27)) |
| <b>Vibration resistance</b>          | 10 Hz ... 2,000 Hz (Amplitude 0.5 mm / 10 g, 20 sweeps per axis, for X, Y, Z axes, 1 octave/min, (EN60068-2-6))  |
| <b>Air humidity</b>                  | 35 % ... 95 %, Relative humidity (no condensation)   |

<sup>1)</sup> Replaces IP69K with ISO 20653: 2013-03.

|  |                              |
|--|------------------------------|
| <b>Electromagnetic compatibility (EMC)</b> | EN 60947-5-2                 |
| <b>Resistance to cleaning agent</b>        | ECOLAB                       |
| <b>UL File No.</b>                         | NRKH.E181493 & NRKH7.E181493 |

<sup>1)</sup> Replaces IP69K with ISO 20653: 2013-03.

## Smart Task

|                                 |  |
|---------------------------------|--|
| <b>Smart Task name</b>          | Base logics  |
| <b>Logic function</b>           | Direct<br>AND<br>OR<br>Window<br>Hysteresis                                    |
| <b>Timer function</b>           | Deactivated<br>On delay<br>Off delay<br>ON and OFF delay<br>Impulse (one shot) |
| <b>Inverter</b>                 | Yes  |
| <b>Switching frequency</b>      | SIO Logic: 10 Hz <sup>1)</sup><br>IOL: 10 Hz <sup>2)</sup>                     |
| <b>Response time</b>            | SIO Logic: < 0.1 s <sup>1)</sup><br>IOL: < 0.1 s <sup>2)</sup>                 |
| <b>Repeatability</b>            | <sup>2)</sup>  |
| <b>Switching signal</b>         |  |
| Switching signal $Q_{L1}$       | Switching output   |
| Switching signal $\bar{Q}_{L1}$ | Switching output   |

<sup>1)</sup> Use of Smart Task functions without IO-Link communication (SIO mode).

<sup>2)</sup> Use of Smart Task functions with IO-Link communication function.

## Diagnosis

|                         |     |
|-------------------------|-----|
| <b>Device status</b>    | Yes |
| <b>Quality of teach</b> | Yes |

## Classifications

|                     |          |
|---------------------|----------|
| <b>ECLASS 5.0</b>   | 27270904 |
| <b>ECLASS 5.1.4</b> | 27270904 |
| <b>ECLASS 6.0</b>   | 27270904 |
| <b>ECLASS 6.2</b>   | 27270904 |
| <b>ECLASS 7.0</b>   | 27270904 |
| <b>ECLASS 8.0</b>   | 27270904 |
| <b>ECLASS 8.1</b>   | 27270904 |
| <b>ECLASS 9.0</b>   | 27270904 |
| <b>ECLASS 10.0</b>  | 27270904 |
| <b>ECLASS 11.0</b>  | 27270904 |
| <b>ECLASS 12.0</b>  | 27270903 |
| <b>ETIM 5.0</b>     | EC002719 |
| <b>ETIM 6.0</b>     | EC002719 |

|                       |          |
|-----------------------|----------|
| <b>ETIM 7.0</b>       | EC002719 |
| <b>ETIM 8.0</b>       | EC002719 |
| <b>UNSPSC 16.0901</b> | 39121528 |

### Dimensional drawing (Dimensions in mm (inch))

Dimensional drawing, sensor

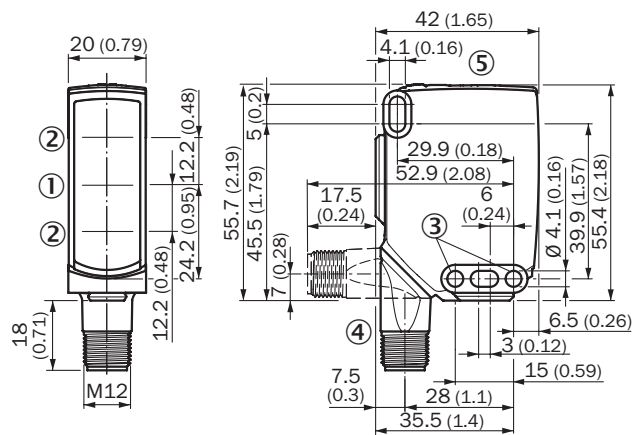

- ① Center of optical axis, sender
- ② Center of optical axis, receiver
- ③ Mounting hole, Ø 4.1 mm
- ④ Connection
- ⑤ Display and adjustment elements

### Adjustments

Display and adjustment elements

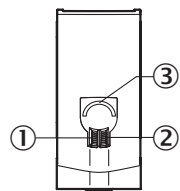

- ① LED indicator green
- ② LED indicator yellow
- ③ LED blue

### Connection type

M12 male connector, 4-pin

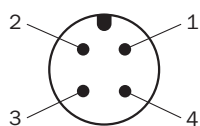

### Connection diagram

Cd-413

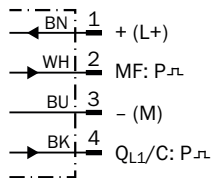

### Truth table

Push-pull: PNP/NPN – dark switching  $\bar{Q}$

|                         | Dark switching $\bar{Q}$ (normally closed (upper switch), normally open (lower switch)) |                             |
|-------------------------|---|-----------------------------|
|                         | Object not present → Output HIGH  | Object present → Output LOW |
| Light receive           | ✗   | ✓                           |
| Light receive indicator | ✗   | ☀                           |
| Load resistance to L+   | ✗   | ⚠                           |
| Load resistance to M    | ⚠   | ✗                           |
|                         |   |                             |

Push-pull: PNP/NPN - light switching Q

|                         | Light switching Q (normally open (upper switch), normally closed (lower switch)) |                              |
|-------------------------|--|------------------------------|
|                         | Object not present → Output LOW  | Object present → Output HIGH |
| Light receive           | ✗  | ✓                            |
| Light receive indicator | ✗  | ☀                            |
| Load resistance to L+   | ⚠  | ✗                            |
| Load resistance to M    | ✗  | ⚠                            |
|                         |  |                              |

### Characteristic curve

#### Dynamic blind zone

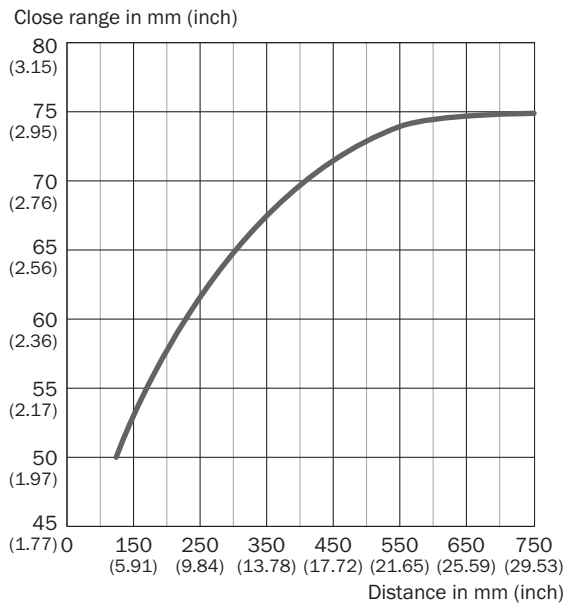

Minimum distance in mm (y) between the set sensing range (x) and white background (90 % remission)

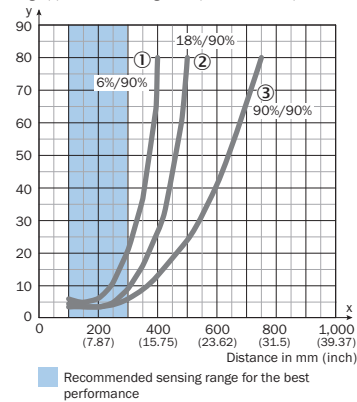

Example: Safe suppression of the background

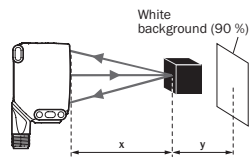

Black object (6 % remission)  
Set sensing range  $x = 300$  mm  
Needed minimum distance to white background  $y = 20$  mm

- ① Black object, 6% remission factor
- ② Gray object, 18% remission factor
- ③ White object, 90% remission factor

### Light spot size

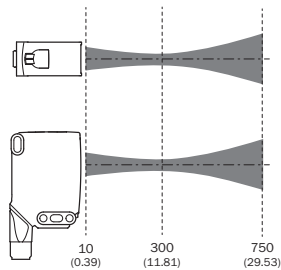
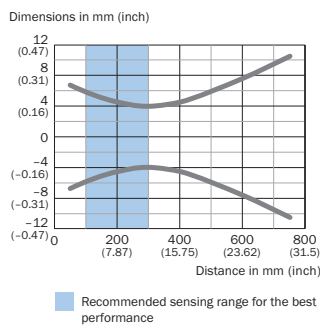



### Sensing range diagram

WTS16P-xxxx3xx

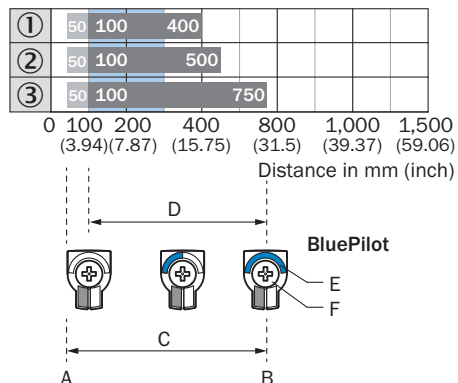

Recommended sensing range for the best performance

|   |   |
|---|---|
| 1 | Black object, 6% remission factor                         |
| 2 | Gray object, 18% remission factor                         |
| 3 | White object, 90% remission factor                        |
| A | Sensing range min. in mm                                  |
| B | Sensing range max. in mm                                  |
| C | Field of view   |
| D | Adjustable switching threshold for background suppression |
| E | Sensing range indicator                                   |
| F | Teach-Turn adjustment                                     |

### Recommended accessories

Other models and accessories → [www.sick.com/W16](http://www.sick.com/W16)

|                              | Brief description   | Type               | Part no. |
|------------------------------|---|--------------------|----------|
| Universal bar clamp systems  |   |                    |          |
|                              | Plate N02 for universal clamp bracket, Zinc plated steel (sheet), Zinc die cast (clamping bracket), Universal clamp (5322626), mounting hardware  | BEF-KHS-N02        | 2051608  |
| Mounting brackets and plates |   |                    |          |
|                              | Adapter for mounting W16 sensors in existing W14-2/W18-3 installations or L25 sensors in existing L28 installations, plastic, fastening screws included   | BEF-AP-W16         | 2095677  |
| Plug connectors and cables   |   |                    |          |
|                              | <ul style="list-style-type: none"> <li><b>Connection type head A:</b> Female connector, M12, 4-pin, straight, A-coded</li> <li><b>Connection type head B:</b> Flying leads</li> <li><b>Signal type:</b> Sensor/actuator cable</li> <li><b>Cable:</b> 5 m, 4-wire, PVC</li> <li><b>Description:</b> Sensor/actuator cable, unshielded</li> <li><b>Application:</b> Zones with chemicals</li> </ul> | YF2A14-050VB3XLEAX | 2096235  |

|   | Brief description  | Type       | Part no. |
|---|--|------------|----------|
|  | <ul style="list-style-type: none"><li>• <b>Connection type head A:</b> Male connector, M12, 4-pin, straight</li><li>• <b>Description:</b> Unshielded</li><li>• <b>Connection systems:</b> Screw-type terminals</li><li>• <b>Permitted cross-section:</b> ≤ 0.75 mm<sup>2</sup></li></ul> | STE-1204-G | 6009932  |

## SICK AT A GLANCE

SICK is one of the leading manufacturers of intelligent sensors and sensor solutions for industrial applications. A unique range of products and services creates the perfect basis for controlling processes securely and efficiently, protecting individuals from accidents and preventing damage to the environment.

We have extensive experience in a wide range of industries and understand their processes and requirements. With intelligent sensors, we can deliver exactly what our customers need. In application centers in Europe, Asia and North America, system solutions are tested and optimized in accordance with customer specifications. All this makes us a reliable supplier and development partner.

Comprehensive services complete our offering: SICK LifeTime Services provide support throughout the machine life cycle and ensure safety and productivity.

For us, that is “Sensor Intelligence.”

## WORLDWIDE PRESENCE:

Contacts and other locations –[www.sick.com](http://www.sick.com)