

# DBS60I-BDEC01024

DBS60

INCREMENTAL ENCODERS

**SICK**  
Sensor Intelligence.

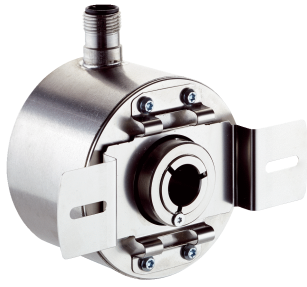

Illustration may differ



### Ordering information

Type	Part no.
DBS60I-BDEC01024	1100933

Other models and accessories → [www.sick.com/DBS60](http://www.sick.com/DBS60)

### Detailed technical data

#### Performance

<b>Pulses per revolution</b>	1,024
<b>Measuring step</b>	90°, electric/pulses per revolution
<b>Measuring step deviation</b>	± 18° / pulses per revolution
<b>Error limits</b>	Measuring step deviation x 3
<b>Duty cycle</b>	≤ 0.5 ± 5 %

#### Interfaces

<b>Communication interface</b>	Incremental
<b>Communication Interface detail</b>	HTL / Push pull
<b>Number of signal channels</b>	6-channel
<b>Initialization time</b>	< 5 ms <sup>1)</sup>
<b>Output frequency</b>	≤ 300 kHz <sup>2)</sup>
<b>Load current</b>	≤ 30 mA, per channel
<b>Power consumption</b>	≤ 1 W (without load)

<sup>1)</sup> Valid signals can be read once this time has elapsed.

<sup>2)</sup> Up to 450 kHz on request.

#### Electrical data

<b>Connection type</b>	Male connector, M12, 8-pin, radial
<b>Supply voltage</b>	10 ... 27 V
<b>Reference signal, number</b>	1
<b>Reference signal, position</b>	90°, electric, logically gated with A and B
<b>Reverse polarity protection</b>	✓
<b>Short-circuit protection of the outputs</b>	✓ <sup>1)</sup>
<b>MTTFd: mean time to dangerous failure</b>	500 years (EN ISO 13849-1) <sup>2)</sup>

<sup>1)</sup> Short-circuit opposite to another channel, US or GND permissible for maximum 30 s.

<sup>2)</sup> This product is a standard product and does not constitute a safety component as defined in the Machinery Directive. Calculation based on nominal load of components, average ambient temperature 40°C, frequency of use 8760 h/a. All electronic failures are considered hazardous. For more information, see document no. 8015532.

## Mechanical data

<b>Mechanical design</b>	Blind hollow shaft
<b>Shaft diameter</b>	10 mm
<b>Flange type / stator coupling</b>	2-sided stator coupling, slot, screw hole circle 63–83 mm
<b>Weight</b>	0.44 kg <sup>1)</sup>
<b>Shaft material</b>	Stainless steel V2A
<b>Flange material</b>	Stainless steel V2A
<b>Housing material</b>	Stainless steel V2A
<b>Shaft sealing ring material</b>	FKM80
<b>Start up torque</b>	2.1 Ncm (+20 °C)
<b>Operating torque</b>	2 Ncm (+20 °C)
<b>Permissible movement static</b>	± 0.3 mm (radial) ± 0.5 mm (axial)
<b>Permissible movement dynamic</b>	± 0.1 mm ± 0.2 mm
<b>Operating speed</b>	≤ 6,000 min <sup>-1</sup> <sup>2)</sup>
<b>Moment of inertia of the rotor</b>	52 gcm <sup>2</sup>
<b>Bearing lifetime</b>	3.6 x 10 <sup>9</sup> revolutions
<b>Angular acceleration</b>	≤ 500,000 rad/s <sup>2</sup>

<sup>1)</sup> Based on encoder with male connector.

<sup>2)</sup> Maximum speed which does not cause mechanical damage to the encoder. Impact on the service life and signal quality is possible. Please note the maximum output frequency.

## Ambient data

<b>EMC</b>	According to EN 61000-6-2 and EN 61000-6-3
<b>Enclosure rating</b>	IP67, male connector (IEC 60529) <sup>1)</sup>
<b>Permissible relative humidity</b>	90 % (Condensation not permitted)
<b>Operating temperature range</b>	-20 °C ... +85 °C
<b>Storage temperature range</b>	-40 °C ... +100 °C, without package
<b>Resistance to shocks</b>	100 g, 6 ms (EN 60068-2-27)
<b>Resistance to vibration</b>	10 g, 10 Hz ... 2,000 Hz (EN 60068-2-6)

<sup>1)</sup> With mating connector fitted.

## Classifications

<b>eCl@ss 5.0</b>	27270501
<b>eCl@ss 5.1.4</b>	27270501
<b>eCl@ss 6.0</b>	27270590
<b>eCl@ss 6.2</b>	27270590
<b>eCl@ss 7.0</b>	27270501
<b>eCl@ss 8.0</b>	27270501
<b>eCl@ss 8.1</b>	27270501
<b>eCl@ss 9.0</b>	27270501
<b>eCl@ss 10.0</b>	27270501
<b>eCl@ss 11.0</b>	27270501

<b>eCl@ss 12.0</b>	27270501
<b>ETIM 5.0</b>	EC001486
<b>ETIM 6.0</b>	EC001486
<b>ETIM 7.0</b>	EC001486
<b>ETIM 8.0</b>	EC001486
<b>UNSPSC 16.0901</b>	41112113

### Dimensional drawing (Dimensions in mm (inch))

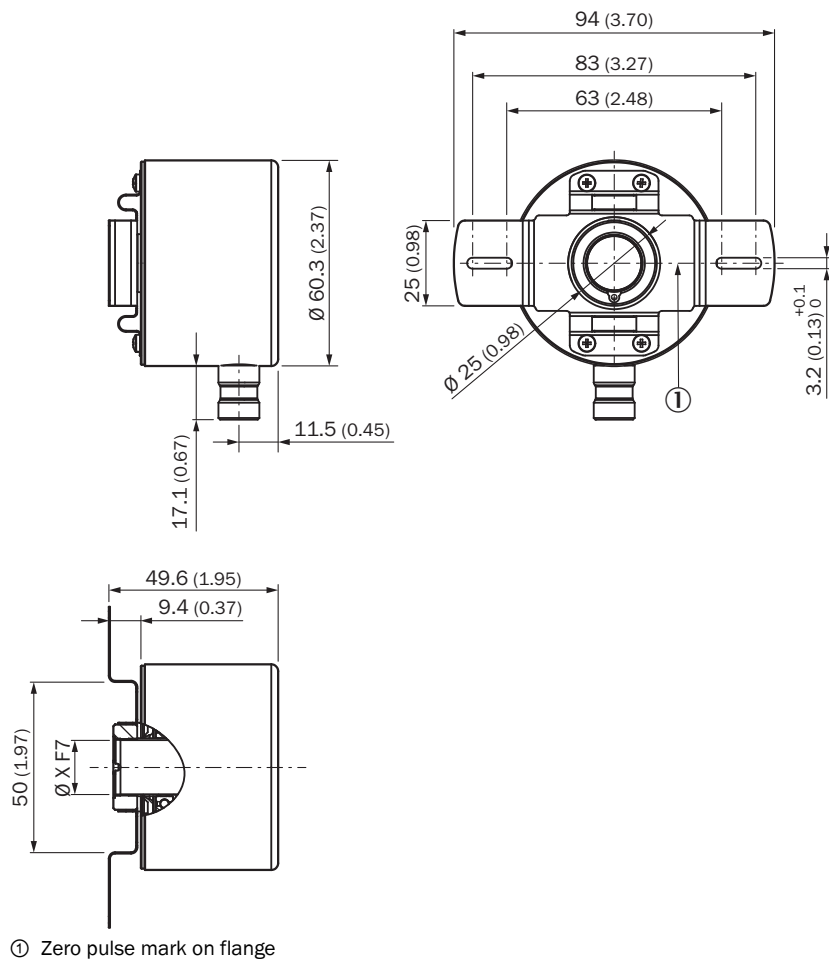

### Attachment specifications

Blind hollow shaft

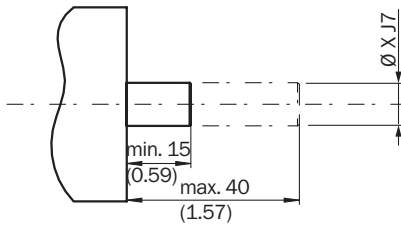

Customer side

Type Blind hollow shaft	Shaft diameter xJ7
DBS60I-BAxxxxxxx	6 mm
DBS60I-BBxxxxxxx	8 mm
DBS60I-BDxxxxxxx	10 mm
DBS60I-BExxxxxxx	12 mm
DBS60I-BGxxxxxxx	14 mm
DBS60I-BHxxxxxxx	15 mm

### PIN assignment

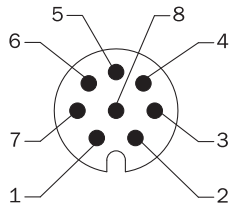

View of M12 male device connector on cable / housing

Wire colors (cable connection)	Male connector M12, 8-pin	TTL/HTL signal	Explanation
Brown	1	A-	Signal cable
White	2	A	Signal cable
Black	3	B-	Signal cable
Pink	4	B	Signal cable
Yellow	5	Z-	Signal cable
Purple	6	Z	Signal cable
Blue	7	GND	Ground connection
Red	8	+U <sub>S</sub>	Supply voltage
Screen	Screen	Screen	Screen connected to housing on encoder side

Diagrams

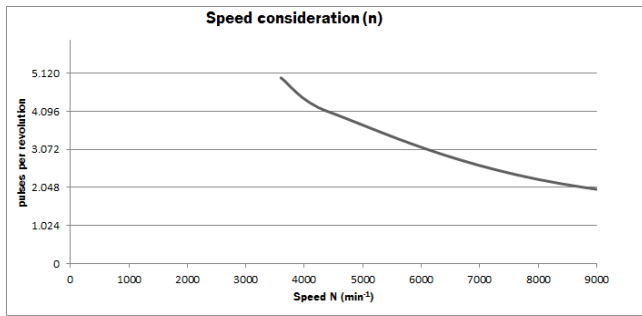

Signal outputs for electrical interfaces TTL and HTL

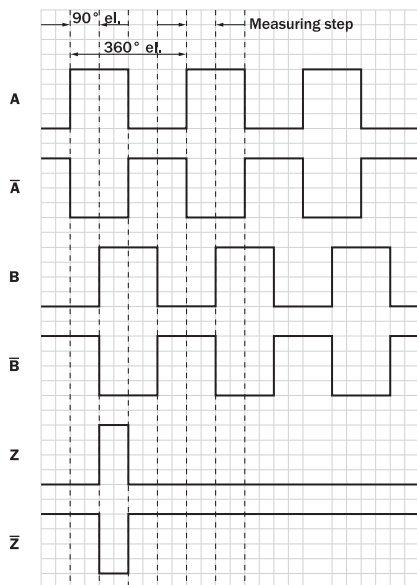

Cw with view on the encoder shaft in direction "A", compare dimensional drawing.

Supply voltage	Output
4,5 V ... 5,5 V	TTL
10 V ... 30 V	TTL
10 V ... 27 V	HTL
4,5 V ... 30 V	TTL/HTL universal
4,5 V ... 30 V	TTL

## Operation note

Hollow shaft

















Attention! If stator coupling is mounted, the zero pulse mark can be hidden by the stator coupling

- ① Zero pulse mark on flange
- ② Zero pulse is active when screw of clamping is inline with zero pulse mark on flange or housing mark

## Recommended accessories

Other models and accessories → [www.sick.com/DBS60](http://www.sick.com/DBS60)

	Brief description	Type	Part no.
<b>Flanges</b>			
	Two-sided stator coupling, screw hole circle diameter 63 mm, slot width 3.2 mm	BEF-DS-09	2076214
	Two-sided stator coupling, slot, slot radius 63 mm – 83 mm, slot width 3.2 mm	BEF-DS-10	2076215
	One-sided stator coupling, slots, slot radius 32.75 mm – 142.65 mm, slot width 4.5 mm	BEF-DS-11	2076216
	Torque support, 1-sided, slotted hole, screw hole radius 31.5 mm - 48.5 mm, hole width 5.1 mm	BEF-DS-12	2076217
	One-sided stator coupling, slot, slot radius 32.1 mm – 37.6 mm, slot width 4.5 mm	BEF-DS-14	2076678
	Flange adapter, adaptation of face mount flange with 36 mm centering hub to 50 mm servo flange, stainless steel, Including 3 countersunk screws with Precote 85-8 coating; M4*12	BEF-FA-036-050-I	2094778
<b>Plug connectors and cables</b>			
	Head A: cable Head B: Flying leads Cable: SSI, Incremental, HIPERFACE®, PUR, halogen-free, shielded	LTG-2308-MWENC	6027529
	Head A: cable Head B: Flying leads Cable: SSI, Incremental, PUR, shielded	LTG-2411-MW	6027530
	Head A: cable Head B: Flying leads Cable: SSI, TTL, HTL, Incremental, PUR, halogen-free, shielded	LTG-2612-MW	6028516

	Brief description	Type	Part no.
	Head A: female connector, M12, 8-pin, straight, A-coded Head B: Flying leads Cable: Incremental, SSI, PUR, halogen-free, shielded, 2 m	DOL-1208-G02MIE1	2120313
	Head A: female connector, M12, 8-pin, straight, A-coded Cable: shielded	YF12ES8-0050S5586A	2097334
	Head A: male connector, M12, 8-pin, straight, A-coded Cable: shielded	YM12ES8-0050S5586A	2097337
<b>Shaft adaptation</b>			
	Collet metal for hollow shaft, shaft diameter 10 mm, outer diameter 5/8" (15.875 mm), metal	SPZ-58Z-010-M	2076220
	Collet plastic insulated for hollow shaft, shaft diameter 10 mm, outer diameter 5/8" (15.875 mm), plastic	SPZ-58Z-010-P	2076230
	Collet metal for hollow shaft, shaft diameter 11 mm, outer diameter 5/8" (15.875 mm), metal	SPZ-58Z-011-M	2094671



## SICK AT A GLANCE

SICK is one of the leading manufacturers of intelligent sensors and sensor solutions for industrial applications. A unique range of products and services creates the perfect basis for controlling processes securely and efficiently, protecting individuals from accidents and preventing damage to the environment.

We have extensive experience in a wide range of industries and understand their processes and requirements. With intelligent sensors, we can deliver exactly what our customers need. In application centers in Europe, Asia and North America, system solutions are tested and optimized in accordance with customer specifications. All this makes us a reliable supplier and development partner.

Comprehensive services complete our offering: SICK LifeTime Services provide support throughout the machine life cycle and ensure safety and productivity.

For us, that is “Sensor Intelligence.”

## WORLDWIDE PRESENCE:

Contacts and other locations –[www.sick.com](http://www.sick.com)