

Part number

# MAV 10.220



Hood, C-TYPE series, with 4 pegs, M20 x 2 double top cable entry, size "57.27", high construction

#### Product description

<b>Product type</b>	Hood
<b>Series</b>	C-TYPE
<b>Closing type</b>	With 4 pegs
<b>Size</b>	Size "57.27"
<b>Cable entry</b>	Double top cable entry M20 x 2
<b>Specification</b>	High construction

#### Technical data

<b>IP degree of protection</b>	IP66 (and IP69 DIN 40050 - 9)
--------------------------------	-------------------------------

#### Further technical details

<b>Weight</b>	217,00 g
<b>Operating temperature range (min, max)</b>	-40°C...+125°C

#### Material properties

<b>Colour</b>	RAL 7040 grey
<b>RoHs conformity</b>	Compliant
<b>China RoHs - EFUP</b>	E
<b>REACH SVHC substances</b>	No

#### Approvals / Standards

<b>Certifications</b>	DNV-GL, BV
<b>UL</b>	ECBT2
<b>cUL</b>	ECBT8

#### General ordering information

<b>EAN13 code</b>	8015747052313
<b>eCl@ss 8.1</b>	27440202
<b>ETIM 7.0</b>	EC000437

#### Packaging Information

<b>Sub-packaging weight</b>	1,09 kg
<b>Sub-packaging description</b>	Plastic packaging
<b>Sub-packaging quantity</b>	5 Pcs
<b>Sub-packaging EAN barcode</b>	8015747052320

Part number

# MAV 10.220



Catalogue drawings

**CZAV L2 - (MZAV L2) - [MZFV L2]**

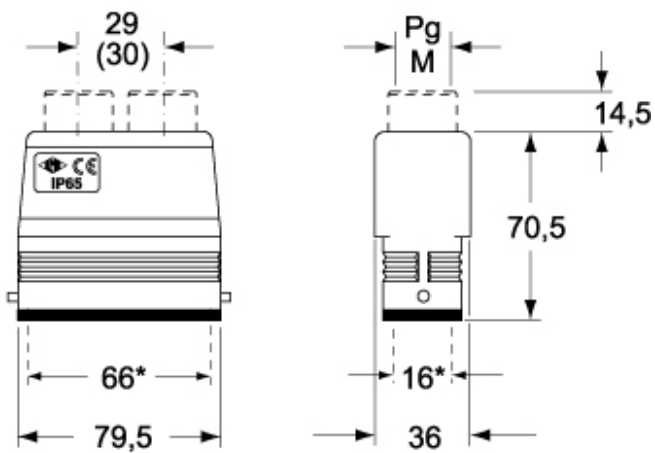

**CAV - MAV - MFV**

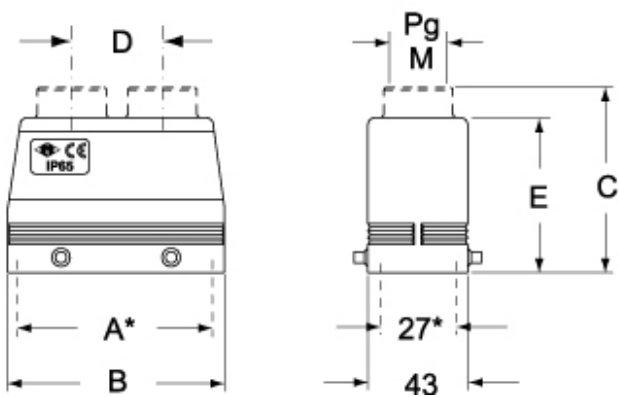

## Notes

Dimensions shown in mm are not binding and may be changed without notice.