

**YCS**

Domaine d'application : Industrie

Manchons de jonction cuivre

**Description :**

Cuivre électrolytique.

Etamage électrolythique

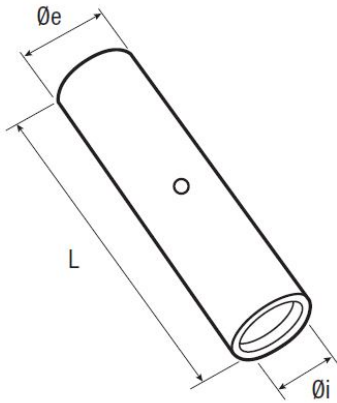

Section câble (mm <sup>2</sup> )	Code article	Réf.	Conditionnement	Ø i	Øe	L	Matrice
240	7435341	YCS240TN	5	21,5	29	90	...K28