



Product designation	Adjustable rod lever		
Product type designation	KBL		
General characteristics			
Material	Housing	Polymer thermoplastic	
	Rod	Aluminium-zinc alloy	
Contact characteristics			
Type of contact	1NO+2NC Slow action		
Thermal current I _{th}	A	10	
IEC/EN 60947-5-1 designation	A600 Q300		
Rated insulation voltage U _i	V	690	
Rated impulse withstand voltage U _{imp}	kV	6	
Insulation class	II		
Short-circuit protection with fuse	Class/A	10 gG/SC QUICK FUSE	
Switching speed	min	m/s	0.5
	max	m/s	1.5
IEC Conventional free air thermal current I _{th}	A	10	
Resistance per pole (average value)	mΩ	<10	
Mechanical features			
Operating head fixing	Locking bayonet insert		
Operating torque	Ncm	3	
	ozin	4.25	
Tightening torque (Max)			
Switch fixing	Nm	2.5	
	lbin	22.1	
Contact terminals	Nm	0.8	
	lbin	7	
Body lid screw fixing	Nm	0.8	
	lbin	7	
Conductor section			
AWG/Kcmil	min	16	
	max	14	
IEC	min	mm ²	1 or 2

	max	mm ²	2.5
Cable connection			Self-releasing screw terminal
Cable entry			M20 on the bottom

Operations

Mechanical life	cycles	<10000000
Mechanical operation	cycles/h	3600

Ambient conditions

Temperature	Operating temperature	min	°C	-25
		max	°C	+70
	Storage temperature	min	°C	-40
		max	°C	+70

Resistance & Protection

IP degree	Terminals	IP20
	Body housing	IP65
Pollution degree		3

Dimensions

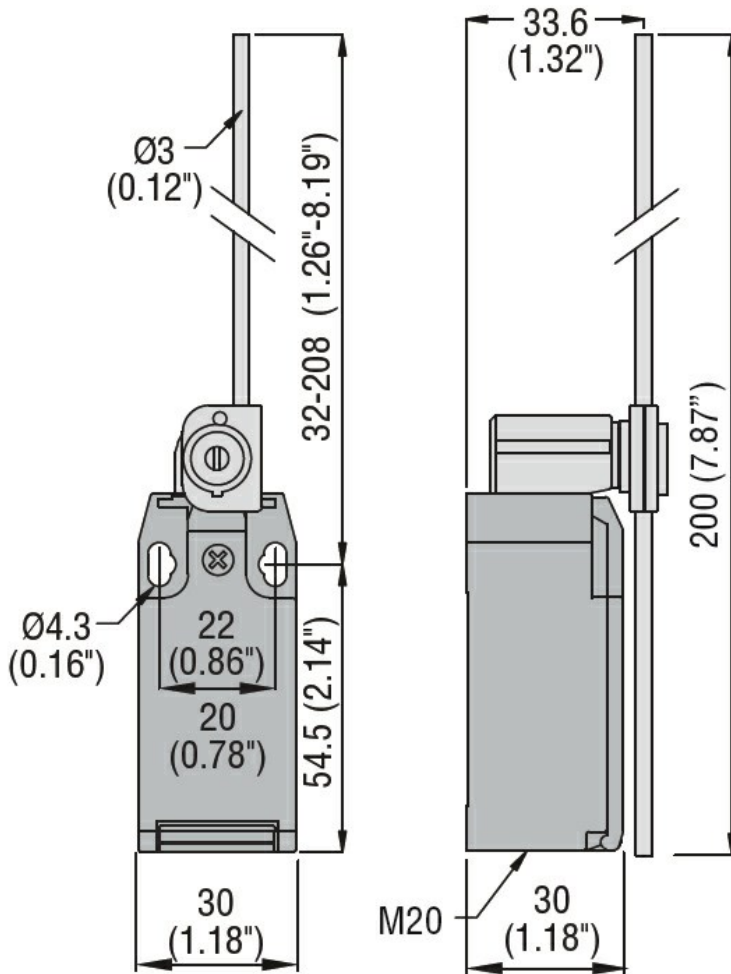

Wiring diagrams

Slow action

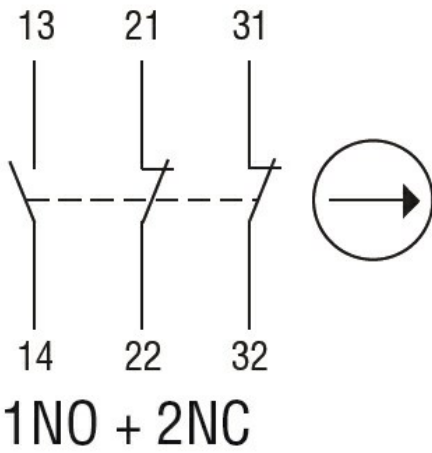

Certifications and compliance

Compliance

CSA C22.2 n° 14

EN 50047

IEC/EN 60204-1

IEC/EN 60947-1

IEC/EN 60947-5-1

UL508

Certificates

CCC

cULus

EAC

ETIM classification

ETIM 8.0

EC000030 - End
switch