

YCS

Domaine d'application : Industrie

Manchons de jonction cuivre

Description :

Cuivre électrolytique.

Etamage électrolytique

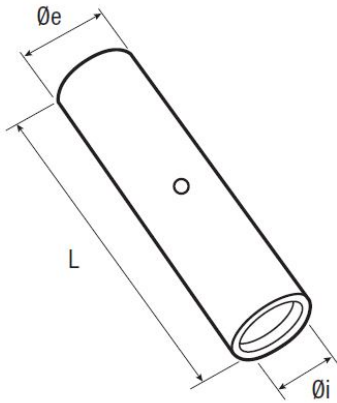

Section câble (mm ²)	Code article	Réf.	Conditionnement	Ø i	Øe	L	Matrice
35	7435271	YCS035TN	50	8,2	12,5	50	...K12 & ...K...-12