



INDUSTRIAL
RELAYS ATEX
HR8020

Product designation

Product type designation

Contact characteristics

Contact configuration			2 NO
Rated insulation voltage U_i IEC/EN	V		250
Rated impulse withstand voltage U_{imp}	kV		4
IEC Conventional free air thermal current I_{th}	A		30
Rated current (I_n)	A		30
Relay control voltage	V		120VAC
Single-phase motor control		230VAC	kW 2.2
Contact impedance		m Ω	50
Contact material			Ag/SnO ₂

Operating times

Closing		ms	25
Opening		ms	25

Operations

Mechanical life		cycles	5000000
Electrical life AC1		cycles	100000

Coil characteristics

Average coil consumption AC at 20°C		VA	4
-------------------------------------	--	----	---

Operating range

	Closing	% U_n	80...110
	Opening	% U_n	20...55

Maximum cycle frequency		cycles/h	360
-------------------------	--	----------	-----

Mechanical features

Operating position		normal	Any
Fixing			With screw

Ambient conditions

Temperature

Operating temperature

min	°C	-40
max	°C	+85

Storage temperature

min	°C	-40
max	°C	+85

Other features

Indication		No
Mechanical contact position indicator		No
Mechanical test actuator		No

Dimensions

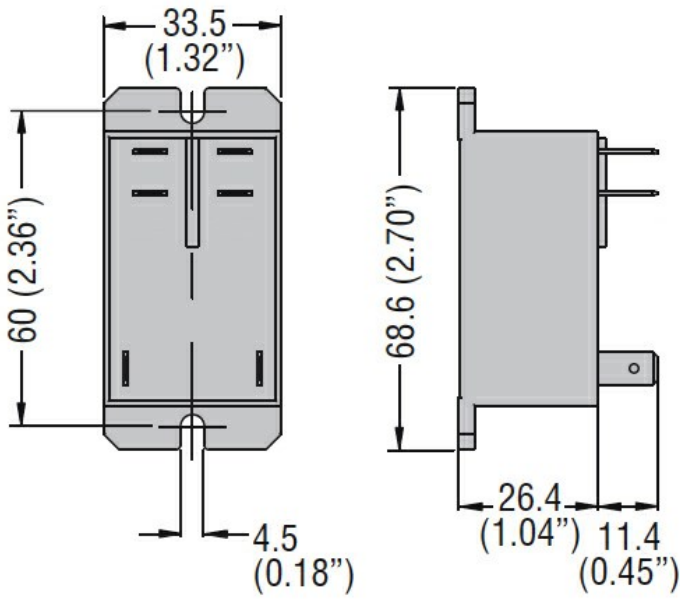

Wiring diagrams

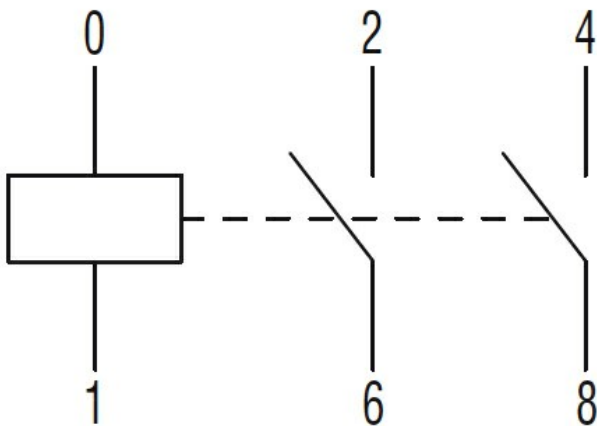

Certifications and compliance

Compliance

IEC/EN/BS 61810-1

Certificates

cURus

EAC

TUV (ATEX)

VDE

ETIM classification

ETIM 8.0

EC001437 –
 Switching relay