



V3DR3-40NE31111

Ranger3

3D MACHINE VISION

SICK
Sensor Intelligence.



Ordering information

Type	Part no.
V3DR3-40NE31111	1105757

Other models and accessories → www.sick.com/Ranger3



Detailed technical data

Features

Task	3D inspection Measuring, 3D
Technology	3D triangulation
Product category	Streaming, flexible
Shutter technology	Global-Shutter
Example field of view	Free of choice by lens selection
Exposure mode	Linear HDR
Illumination	To be ordered separately as accessories
Data synchronization	Free running, encoder triggered, external triggering
3D measurement	✓
Scatter measurement	✓
Reflectance measurement	✓
Spectral range	400 nm ... 950 nm
Lens	C-mount
Optical format	1"
Note	To be ordered separately as accessories

Mechanics/electronics

Connection type	Voltage - I/O: M12, 17-pin male connector Gigabit Ethernet: M12, 8-pin female connector, X-coded
Connector material	M12: Nickel-coated brass
Supply voltage	24 V DC, ± 20 %
Power consumption	12 W
Current consumption	≤ 1.5 A
Enclosure rating	IP20 IP65, by ProFlex protection hood IP67, by ProFlex protection hood

Housing material	Aluminum
Housing color	Blue, powder-coated
Weight	330 g
Dimensions (L x W x H)	77 mm x 55 mm x 55 mm

Performance

Image sensor	CMOS sensor from SICK with ROCC technology, M30
Sensor resolution	2,560 px x 832 px
Scan/frame rate	20,000 3D profiles/s, in AOI 2,500 3D profiles/s, full format
Pixel size	6 µm x 6 µm
Maximum 3D height resolution	16 bits, 1/16 subpixel

Interfaces

Ethernet	✓, UDP/IP
Data transmission rate	1,000 Mbit/s
Configuration software	Ranger3 Studio
Operating system	Windows 7, Windows 10
Programming interface	GenAPI
Digital input	4 x HIGH = 10 V ... 28.8 V
Digital output	2 x TTL
Encoder interface	RS-422

Ambient data

Shock load	15 g, 3 x 6 directions
Vibration load	5 g, 58 Hz ... 150 Hz
Ambient operating temperature	0 °C ... +50 °C ¹⁾
Storage temperature	-20 °C ... +70 °C ¹⁾

¹⁾ Non-condensing.

Classifications

ECLASS 5.0	27310205
ECLASS 5.1.4	27310205
ECLASS 6.0	27310205
ECLASS 6.2	27310205
ECLASS 7.0	27310205
ECLASS 8.0	27310205
ECLASS 8.1	27310205
ECLASS 9.0	27310205
ECLASS 10.0	27310205
ECLASS 11.0	27310205
ECLASS 12.0	27310205
ETIM 5.0	EC001820
ETIM 6.0	EC001820

ETIM 7.0	EC001820
ETIM 8.0	EC001820
UNSPSC 16.0901	43211731

Dimensional drawing (Dimensions in mm (inch))

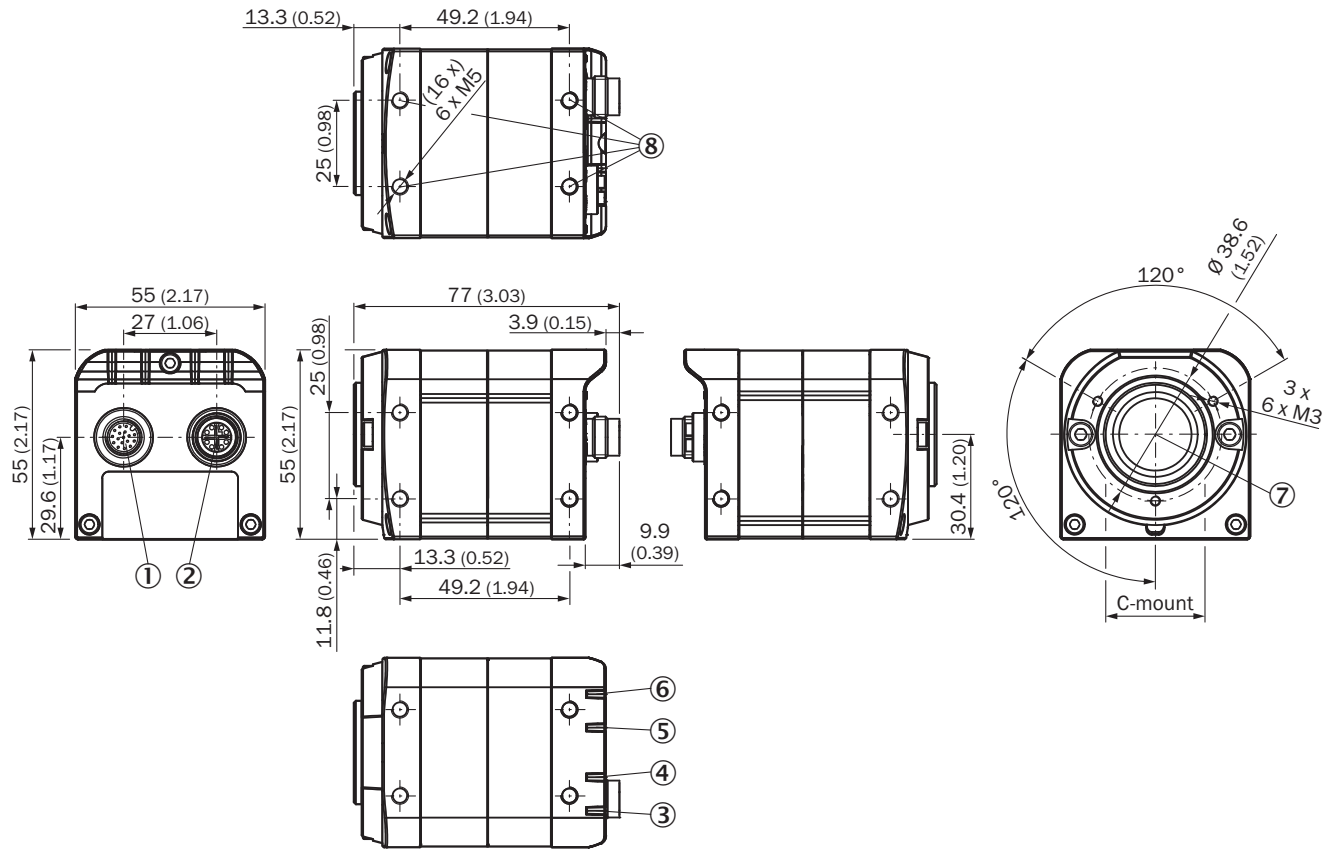

- ① Power I/O connector
- ② Connector Gigabit Ethernet (Gig E)
- ③ LED; On
- ④ LED; State
- ⑤ LED; Link/Data
- ⑥ LED; Laser
- ⑦ Optical axis, receiver
- ⑧ Mounting holes, 4 x M5

Characteristic curve

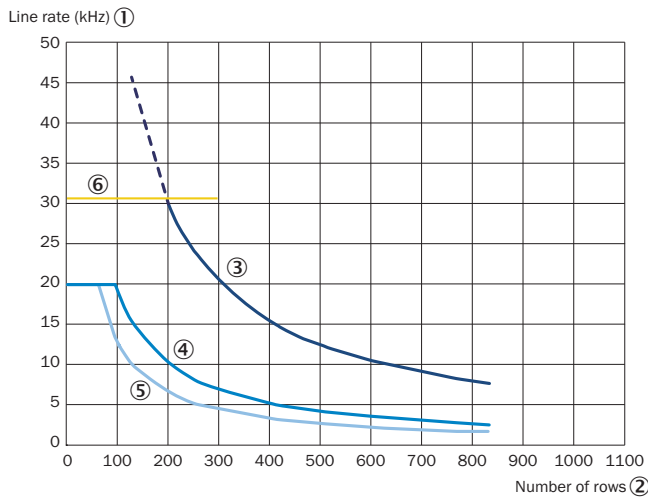

The maximum line rate is based on the number of sensor lines used

- ① Line rate (kHz)
- ② Number of lines
- ③ Ranger3-60, 2,560 columns
- ④ Ranger3-40, 2,560 columns
- ⑤ Ranger3-30, 1,536 columns
- ⑥ Bandwidth limitation for 2,560 columns



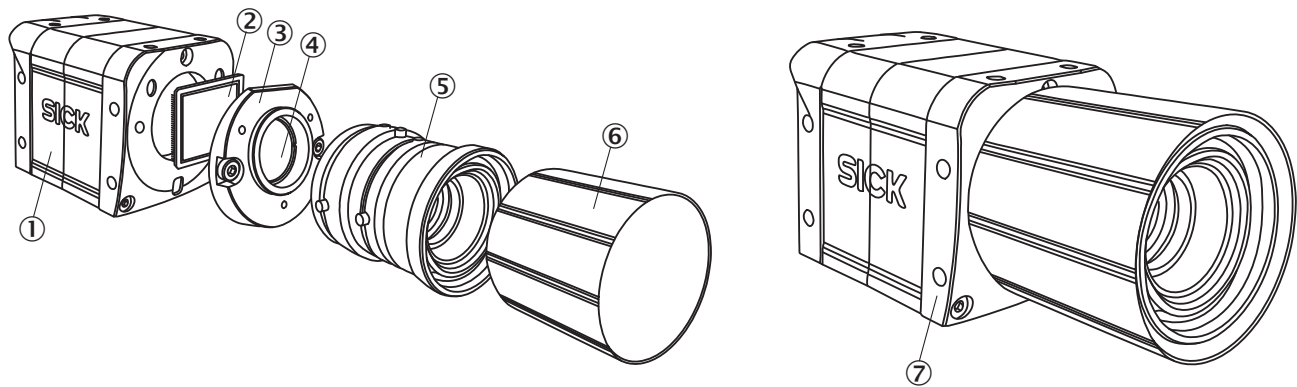

Exploded view



- ① Ranger3 (housing)
- ② CMOS sensor M30
- ③ Scheimpflug adapter, replaceable
- ④ Optical filter, replaceable
- ⑤ C-mount lens, replaceable
- ⑥ Protective hood, replaceable
- ⑦ Installed device with all listed parts

Recommended accessories

Other models and accessories → www.sick.com/Ranger3

	Brief description	Type	Part no.
Lenses and accessories			
	C-Mount lens 1", focal length 25 mm, lens aperture 1.4 – 16	C-mount lens	5327524
Mounting brackets and plates			
	Mounting bracket with camera adapter plate, including screws	Mounting bracket	2091431
Plug connectors and cables			
	<ul style="list-style-type: none"> • Connection type head A: Female connector, M12, 17-pin, straight, A-coded • Connection type head B: Flying leads • Signal type: Sensor/actuator cable, serial, CANopen, digital I/Os • Cable: 3 m, 17-wire, PUR • Description: Sensor/actuator cable, serial, CANopen, digital I/Os, twisted pair, shielded • Application: Drag chain operation 	YF2A2D-030UV1XLEAX	6042772
	<ul style="list-style-type: none"> • Connection type head A: Male connector, M12, 8-pin, straight, X-coded • Connection type head B: Male connector, RJ45, 8-pin, straight • Signal type: Ethernet, Gigabit Ethernet • Cable: 2 m, 8-wire, PUR, halogen-free • Description: Ethernet, Gigabit Ethernet, shielded • Application: Zones with oils and lubricants 	YM2X18-020EG1MRJA8	2106258

Recommended services

Additional services → www.sick.com/Ranger3

	Type	Part no.
Extended warranty		
<ul style="list-style-type: none"> • Product area: Identification solutions, machine vision, Detection and ranging solutions, safety camera sensors, Safety laser scanners, Safety radar sensors • Range of services: The services correspond to the scope of the statutory manufacturer warranty (SICK general terms of delivery). • Duration: Five-year warranty from delivery date. 	Extended warranty for a total of five years from delivery date	1680671

SICK AT A GLANCE

SICK is one of the leading manufacturers of intelligent sensors and sensor solutions for industrial applications. A unique range of products and services creates the perfect basis for controlling processes securely and efficiently, protecting individuals from accidents and preventing damage to the environment.

We have extensive experience in a wide range of industries and understand their processes and requirements. With intelligent sensors, we can deliver exactly what our customers need. In application centers in Europe, Asia and North America, system solutions are tested and optimized in accordance with customer specifications. All this makes us a reliable supplier and development partner.

Comprehensive services complete our offering: SICK LifeTime Services provide support throughout the machine life cycle and ensure safety and productivity.

For us, that is “Sensor Intelligence.”

WORLDWIDE PRESENCE:

Contacts and other locations –www.sick.com