



Level control relay multifunction. Single voltage. Modular version LVM40 Multifunction: emptying and alarms, filling and alarms, emptying with priority start-up change, filling with priority start-up change, well draining and tank filling and alarms

Product designation

Product type designation

Function

Auxiliary supply

Supply voltage Type	Single voltage		
Rated auxiliary supply voltage U_s			
AC	min	VAC	380
	Max	VAC	415
Operating voltage range	0.85...1.1 U_s		
Rated frequency	Hz	50/60	
Power consumption Max	VA	4.5	
Power dissipation Max	W	2.8	

Output characteristics

Number of connectable electrodes	Nr.	5	
Type of electrode	Electrode and electrode holders: SN1 / SCM / CGL / PS31 / PS3S or similar		
Electrode voltage	10 Vpp		
Sensitivity	k Ω	2.5...200 adjustable	

Time delay

Tripping time	s	1	
Resetting time	s	1	
Probe tripping delay	1...10s		

Relay outputs

Number of relays	Nr.	2	
Relay state	Normally de-energised, energises at tripping		

Contact arrangement		1 changeover contact C/O-SPDT + 1 contact NO-SPST
Rated operational voltage AC (IEC)	VAC	250
Maximum switching voltage	VAC	400
IEC Conventional free air thermal current I _{th}	A	8
UL/CSA and IEC/EN 60947-5-1 designation		B300
Electrical life (with rated load)	cycles	10 ⁵
Mechanical life	cycles	30x10 ⁶

Indications

Indication		1 green LED indicator for power on 2 red LEDs for relay state 2 red LEDs for probe state
------------	--	--

Functions

3 detecting electrodes (MIN, MAX and COM)	No
5 detecting electrodes (MIN1, MAX1, MIN2, MAX2 and COM)	Yes
Sensitivity adjustment 2.5...50k Ω	No
Sensitivity adjustment 2.5...100k Ω	No
Sensitivity adjustment 2.5...200k Ω	Yes
Adjustable sensitivity full-scale value 25-50-100-200 k Ω	Yes
Separate sensitivity adjustment for MAX probe (foam detection)	Yes
Emptying function	Yes
Filling function	Yes
Emptying function with MIN and/or MAX alarm	Yes
Filling function with MIN and/or MAX alarm	Yes
Emptying function with pump priority change	Yes
Filling function with pump priority change	Yes
Tank filling, well drawing and alarm	Yes
Filling-emptying adjustment selector	No
Programming selector for 5 different	Yes
Motor start-up priority change	No

Connections

Tightening torque for terminals	max	Nm	0.8
	max	Ibin	7
Conductor cross section			
AWG/Kcmil	min	AWG	24
	Max	AWG	12
IEC	min	mm ²	0.2
	Max	mm ²	4

Insulations

Rated insulation voltage U _i	V	415
Rated impulse withstand voltage U _{imp}	kV	6
Operating frequency withstand voltage	kV	4
Double insulation Supply / relay / electrode	VAC	≤250

Ambient conditions

Temperature

Operating temperature

min	°C	-20
max	°C	+60

Storage temperature

min	°C	-30
max	°C	+80

Housing

Execution	Modular DIN rail mounting	
N° of modules	3	
Material	Self-extinguishing polyamide	
Mounting	35mm DIN rail (IEC/EN 60715) or by screws using extractable clips	
IEC degree of protection	IP40 on front / IP20 on terminals	
Dimensions (W x H x D)	mm	53.5 x 104.7 x 64.9
Weight	g	278

Dimensions

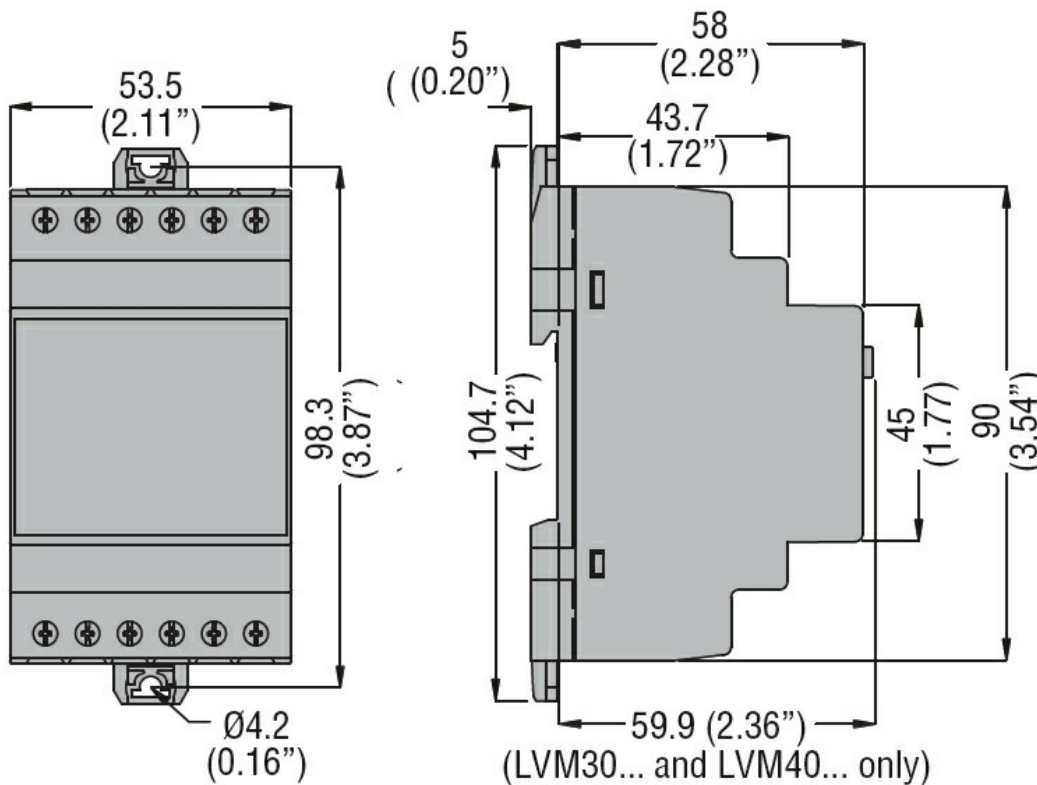

Wiring diagrams

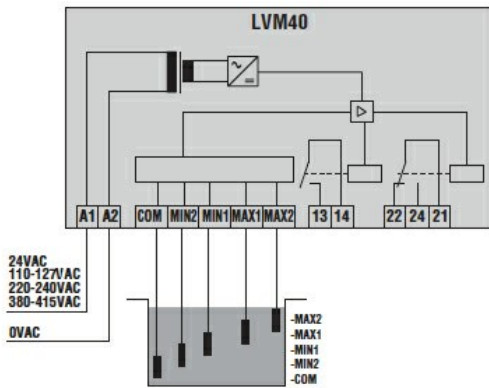

Certifications and compliance

Compliance

CSA C22.2 n° 14

IEC/EN 60255-5

IEC/EN 61000-6-2

IEC/EN 61000-6-3

UL508

Certificates

cULus

EAC

ETIM classification

ETIM 8.0

EC001447 - (Fill)
level monitoring
relay