



SMART [PRO] 2.0 is an outdoor and indoor medium-power LED floodlight, suitable for sports areas and facilities. It can be installed on the wall, ceiling or floor thanks to the galvanized steel powder coated bracket with trivalent passivation equipped with adjustable goniometric scale.

Die-cast aluminium body EN AB 46100, with passive heatsink integrated, polyester powder coated with trivalent passivation. PCB metal core with CSP LED.

Reflector in metallised HT or anodised and polished aluminium. Front glass 4mm thick, anti-aging silicone gaskets and stainless steel A2 external screws. Plastic venting and anti-condensation device. Electrical connection via IP68 connector for 1.5mm<sup>2</sup> cables. Insulation class 1.

Driver integrated with 1-10 V or DALI version. Nine different types of optics available, three types of Color Temperature (3000K / 4000K / 5700K) and two different types of Color Rendering Index (CRI> 70, CRI> 80). Designed to withstand overvoltage up to 5KV (differential mode) and 10KV (common mode), temperature range from -30 °C to + 50 °C, water and dust penetration up to IP66 protection degree and to impacts up to grade IK08.

#### GENERAL INFORMATION

Context	Sport, Big Areas
Luminaire	LED luminaire with small, mid and high lumen power
Application	Intérieur/ Extérieur
Unique digital code (Datamatrix)	Attualmente non presente
Couleur	Gris graphite
Type de source lumineuse	LED - Non remplaçable
Puissance du système	165 W
Lifetime	L90B10 (Tq+25°C) > 50000h L90B10 (Tq+40°C) = 40000h L80B10 (Tq+25°C) > 110000h
Poids (kg)	5.7

#### OPTIC AND ILLUMINATING FEATURES

Optique	C3 - Circular 20°
Unified Glare Rating	G*6 - ULOR = 0
Lumen en sortie (Lm)	20500
Efficiency (lm/W)	124
Température de couleur	5700 K
Color Rendering Index	CRI>70
Standard Deviation Colour Matching	SDCM = 5
Photobiological Risk Class	-
Norme	EN60598-1; EN60598-2-5; EN60598-2-24; IEC 62778; IEC62471; EN13201

#### MATERIALS

Garantie	5 ans
Température de stockage	-
Operating temperature	-30 +40 °C
Body	Aluminium moulé sous pression
Vasque	Flat tempered glass 4mm
Optic	Polished quartz and metallized PC HT reflector

#### ELETRICAL AND LIGHTING FEATURES

Tension d'alimentation	220 - 240 V
Fréquence nominale (Hz)	50 / 60
Driver	Included
Overvoltage protection	DM 6 kV / CM 10 kV
Control System	Stand Alone - 1/10V

#### INSTALLATION AND MAINTENANCE

Gasket	Anti-aging silicone	Mouting and installation	High-mast lighting - Wall mounting - Ground mouting
Locking Hook	Hexagonal metric screws	Inclination angle	Rotation on bracket with integrated goniometer
External screw	Stainless steel	Wiring	Watertight connector
Colour	Polyester powder coated	Fixation	Étrier
<b>STANDARDS AND APPROVALS</b>	-	Optic Maintenance	Not available
Classification	-	LED Maintenance	Not available
Appareil avec température de surface réduite	Oui	Driver Box	Intégrée
Certification DIN 18032-3	Oui	Surface maximale exposée au vent	0,085 m2
IPEA	-	-	-
Classe isolement	I	-	-
Indice de protection	IP66	-	-
Résistance aux chocs	IK08	-	-
Test du fil incandescent	-	-	-

#### DIMENSIONS

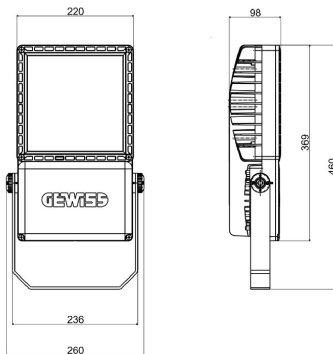

#### DISTRIBUTION PHOTOMETRIQUE

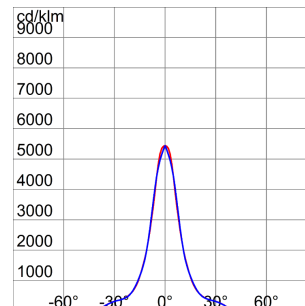

#### SYMBOLE TECHNIQUE



## NORMES ET HOMOLOGATIONS



Les caractéristiques, dimensions, dessins et images sont communiqués à titre purement informatif et peuvent faire l'objet de modification sans aucun préavis - Dernière mise à jour 02/03/2020