

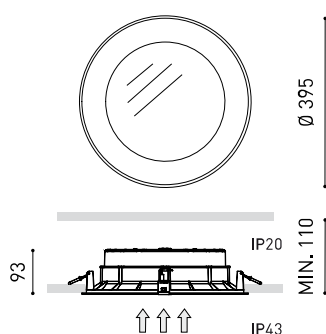

DIMENSIONS



TROPHÉES



Nom	DROP MAXI 2 DIM DALI 4000K WT
Référence	A2350242WT
Couleur	Blanc Texturé
RAL	9016
Catégorie	CEILING RECESSED

Type	LED
Flux lumineux brut	2500 lm
Température de couleur	4000 K
Stabilité chromatique	MacAdam Step 2
Indice de reproduction chromatique	CRI > 90
Puissance	15 W
Courant	350 mA
Efficacité	167 lm/W
Durée de vie de la LED	L80B10 > 60.000h

Efficacité lumineuse	84%
Angle du faisceau lumineux	97°

Driver	Inclus - Connecté
Valeurs de puissance du système	17,24 W
Tension	220V/240V
Fréquence	50/60 Hz
Variation d'intensité	DALI
Classe d'isolation électrique	□

Étanchéité	IP43
Contrôle sans fil	Veuillez consulter
Alimentation d'urgence	Veuillez consulter
Résistance aux chocs	IK07
Dimensions d'encastrement	Ø375 mm
Poids	2800 g
Poids avec emballage	3340,5 g
Dimensions de l'emballage	454 x 444 x 136 mm
Unités par emballage	1
Matériaux	Aluminium / Polyméthacrylate De Méthyle

PRODUIT

DROP MAXI 2 DIM DALI 4000K WT

A2350242WT

Blanc Texturé

9016

CEILING RECESSED

SOURCE DE LUMIÈRE

LED

2500 lm

4000 K

MacAdam Step 2

CRI > 90

15 W

350 mA

167 lm/W

L80B10 > 60.000h

LUMINAIRE | DONNÉES PHOTOMÉTRIQUES

84%

97°

LUMINAIRE | DONNÉES ÉLECTRIQUES

Inclus - Connecté

17,24 W

220V/240V

50/60 Hz

DALI

□

D'AUTRES DONNÉES

IP43

Veuillez consulter

Veuillez consulter

IK07

Ø375 mm

2800 g

3340,5 g

454 x 444 x 136 mm

1

Aluminium / Polyméthacrylate De Méthyle



Avec la lumière allumée, l'éclairage du Drop produit un effet qui, grâce à sa clarté, élimine les limites du luminaire. L'effet d'éclairage de ce plafonnier est semblable à celui d'une lucarne naturelle.

DIAGRAMME POLAIRE



DIAGRAMME CONIQUE

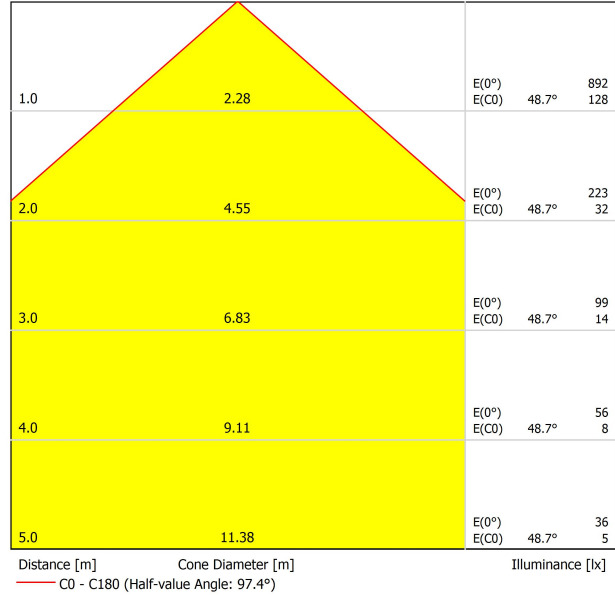

UGR

Glare Evaluation According to UGR											
ρ Ceiling	70	70	50	50	30	70	70	50	50	30	
ρ Walls	50	30	50	30	30	50	30	50	30	30	
ρ Floor	20	20	20	20	20	20	20	20	20	20	
Room Size X Y		Viewing direction at right angles to lamp axis					Viewing direction parallel to lamp axis				
2H	2H	20.0	21.3	20.3	21.5	21.7	20.0	21.3	20.3	21.5	21.7
	3H	21.3	22.4	21.6	22.7	23.0	21.3	22.4	21.6	22.7	23.0
	4H	21.7	22.7	22.0	23.0	23.3	21.7	22.7	22.0	23.0	23.3
	6H	21.8	22.8	22.2	23.1	23.4	21.8	22.8	22.2	23.1	23.4
	8H	21.8	22.7	22.2	23.1	23.4	21.8	22.7	22.2	23.1	23.4
4H	2H	20.5	21.5	20.8	21.8	22.1	20.5	21.5	20.8	21.8	22.1
	3H	21.9	22.8	22.3	23.1	23.5	21.9	22.8	22.3	23.1	23.5
	4H	22.4	23.2	22.8	23.5	23.9	22.4	23.2	22.8	23.5	23.9
	6H	22.6	23.3	23.0	23.6	24.0	22.6	23.3	23.0	23.6	24.0
	8H	22.6	23.3	23.1	23.6	24.1	22.6	23.3	23.1	23.6	24.1
8H	2H	22.7	23.2	23.1	23.6	24.1	22.7	23.2	23.1	23.6	24.1
	4H	22.5	23.1	23.0	23.5	24.0	22.5	23.1	23.0	23.5	24.0
	6H	22.8	23.3	23.2	23.7	24.2	22.8	23.3	23.2	23.7	24.2
	8H	22.9	23.3	23.3	23.7	24.2	22.9	23.3	23.3	23.7	24.2
	12H	22.9	23.3	23.4	23.8	24.3	22.9	23.3	23.4	23.8	24.3
12H	4H	22.5	23.1	23.0	23.5	23.9	22.5	23.1	23.0	23.5	23.9
	6H	22.8	23.2	23.3	23.7	24.1	22.8	23.2	23.3	23.7	24.1
	8H	22.9	23.3	23.4	23.7	24.2	22.9	23.3	23.4	23.7	24.2
Variation of the observer position for the luminaire distances S											
S = 1.0H	+0.2 / -0.2					+0.2 / -0.2					
S = 1.5H	+0.3 / -0.6					+0.3 / -0.6					
S = 2.0H	+0.7 / -1.2					+0.7 / -1.2					
Standard table	BK04					BK04					
Correction Summand	1.9					1.9					
Corrected Glare Indices referring to 2500lm Total Luminous Flux											



Fuente de luz (LED) reemplazable por un profesional autorizado

Replaceable (LED only) light source by an authorized professional.

Source lumineuse (LED) remplaçable par un professionnel agréé

Sorgente luminosa (LED) sostituibile da parte di un professionista autorizzato

Austauschbare (LED) Lichtquelle durch einen autorisierten Fachmann



Equipo de control reemplazable por un profesional autorizado

Replaceable control gear by an authorized professional

Dispositif de commande remplaçable par un professionnel agréé

Alimentatore sostituibile da parte di un professionista autorizzato

Auswechselbares Betriebsgerät durch autorisierten Fachmann

INSTRUCCIONES PARA EL FINAL DE VIDA Y LA ELIMINACIÓN LOS COMPONENTES
 INSTRUCTIONS ON END-OF-LIFE AND COMPONENT DISPOSAL
 INSTRUCTIONS POUR LA GESTION DES COMPOSANTS EN FIN DE VIE ET LEUR MISE AU REBUT
 ISTRUZIONI PER IL FINE VITA E LO SMALTIMENTO DEI COMPONENTI
 ANWEISUNGEN ZUR ENTSORGUNG DER LEUCHTENKOMPONENTEN



Interrumpir la alimentación del aparato
 Cut the power supply to the luminaire
 Couper l'alimentation du luminaire
 Interrompere l'alimentazione dell'apparecchio
 Stromversorgung der Leuchte unterbrechen



Quitar la(s) fuente(s) de luz para el desecho
 Remove light source(s) for disposal
 Retirer la (les) source(s) lumineuse(s) pour l'élimination
 Rimuovere la/le sorgente/e di luce per lo smaltimento
 Lichtquelle(n) zur Entsorgung entfernen



Quitar la batería para el desecho
 Remove the battery for decommissioning
 Retirer la batterie pour sa mise au rebut
 Rimuovere la batteria per la dismissione
 Die Batterie ordnungsgemäß entsorgen



Quitar el equipo de control para el desecho
 Remove control gear for disposal
 Retirer le dispositif de commande pour l'élimination
 Rimuovere l'alimentatore per lo smaltimento
 Betriebsgerät zur Entsorgung ausbauen



Enviar los materiales a un centro de recogida RAEE
 Send the materials to a WEEE collection centre
 Envoyer les matériaux dans une déchetterie DEEE
 Inviare i materiali ad un centro di raccolta RAEE
 Die Materialien in einem WEEE-Zentrum entsorgen

