



# WTT12L-B3543

PowerProx

MULTITASK PHOTOELECTRIC SENSORS

**SICK**  
Sensor Intelligence.



### Ordering information

Type	Part no.
WTT12L-B3543	1072647

Other models and accessories → [www.sick.com/PowerProx](http://www.sick.com/PowerProx)

Illustration may differ



### Detailed technical data

#### Features

<b>Functional principle</b>	Photoelectric proximity sensor
<b>Functional principle detail</b>	Background suppression, Optical time-of-flight
<b>Dimensions (W x H x D)</b>	20 mm x 49.6 mm x 44.2 mm
<b>Housing design (light emission)</b>	Rectangular
<b>Sensing range max.</b>	50 mm ... 1,800 mm <sup>1)</sup>
<b>Sensing range</b>	100 mm ... 1,800 mm <sup>2) 3)</sup>
<b>Type of light</b>	Visible red light
<b>Light source</b>	Laser <sup>4)</sup>
<b>Light spot size (distance)</b>	Ø 12 mm (1,800 mm)
<b>Wave length</b>	658 nm
<b>Laser class</b>	1 (IEC 60825-1 / CDRH 21 CFR 1040.10 & 1040.11)
<b>Adjustment</b>	Single teach-in button (2 x)

<sup>1)</sup> Object with 6 ... 90% remission (based on standard white, DIN 5033).

<sup>2)</sup> Adjustable.

<sup>3)</sup> Object with 90% remission (based on standard white, DIN 5033).

<sup>4)</sup> Average service life: 100,000 h at T<sub>J</sub> = +25 °C.

## Mechanics/electronics

<b>Supply voltage <math>U_B</math></b>	10 V DC ... 30 V DC <sup>1)</sup>
<b>Ripple</b>	$< 5 V_{pp}$ <sup>2)</sup>
<b>Current consumption</b>	70 mA <sup>3)</sup>
<b>Switching output</b>	Push-pull: PNP/NPN <sup>4)</sup>
<b>Number of switching outputs</b>	2 ( $Q_1, Q_2$ ) <sup>4)</sup>
<b>Switching mode</b>	Light switching <sup>4)</sup>
<b>Output current <math>I_{max}</math></b>	$\leq 100$ mA
<b>Response time</b>	$\leq 16.7$ ms <sup>5)</sup>
<b>Switching frequency</b>	30 Hz <sup>6)</sup>
<b>Analog output</b>	-
<b>Input</b>	Sender off
<b>Connection type</b>	Cable with plug M12, 5-pin, 0.3 m <sup>7)</sup>
<b>Cable material</b>	PVC
<b>Conductor cross section</b>	0.14 mm <sup>2</sup>
<b>Circuit protection</b>	A <sup>8)</sup> B <sup>9)</sup> C <sup>10)</sup>
<b>Protection class</b>	III
<b>Weight</b>	80 g
<b>Housing material</b>	Plastic, VISTAL®
<b>Optics material</b>	Plastic, PMMA
<b>Enclosure rating</b>	IP67
<b>Ambient operating temperature</b>	$-35$ °C ... $+50$ °C <sup>11)</sup>
<b>Ambient temperature, storage</b>	$-40$ °C ... $+70$ °C
<b>Warm-up time</b>	$< 15$ min <sup>12)</sup>
<b>Initialization time</b>	$< 300$ ms
<b>UL File No.</b>	NRKH.E181493

<sup>1)</sup> Limit values. Operated in short-circuit protected network: max. 8 A.

<sup>2)</sup> May not exceed or fall below  $U_V$  tolerances.

<sup>3)</sup> Without load. At  $V_S = 24$  V.

<sup>4)</sup>  $Q_1, Q_2 = 2$  switching thresholds, light switching.

<sup>5)</sup> Signal transit time with resistive load.

<sup>6)</sup> With light/dark ratio 1:1.

<sup>7)</sup> Do not bend below 0 °C.

<sup>8)</sup> A =  $V_S$  connections reverse-polarity protected.

<sup>9)</sup> B = inputs and output reverse-polarity protected.

<sup>10)</sup> C = interference suppression.

<sup>11)</sup> As of  $T_a = 45$  °C, a max.load current  $I_{max} = 50$  mA is permitted.

<sup>12)</sup> Below  $T_u = -10$  °C a warm-up time is necessary.

## Safety-related parameters

<b>MTTF<sub>D</sub></b>	138 years
<b>DC<sub>avg</sub></b>	0 %

<b>T<sub>M</sub> (mission time)</b>	20 years
-------------------------------------	----------

Classifications

<b>eCl@ss 5.0</b>	27270904
<b>eCl@ss 5.1.4</b>	27270904
<b>eCl@ss 6.0</b>	27270904
<b>eCl@ss 6.2</b>	27270904
<b>eCl@ss 7.0</b>	27270904
<b>eCl@ss 8.0</b>	27270904
<b>eCl@ss 8.1</b>	27270904
<b>eCl@ss 9.0</b>	27270904
<b>eCl@ss 10.0</b>	27270904
<b>eCl@ss 11.0</b>	27270904
<b>eCl@ss 12.0</b>	27270903
<b>ETIM 5.0</b>	EC002719
<b>ETIM 6.0</b>	EC002719
<b>ETIM 7.0</b>	EC002719
<b>ETIM 8.0</b>	EC002719
<b>UNSPSC 16.0901</b>	39121528

**Dimensional drawing** (Dimensions in mm (inch))

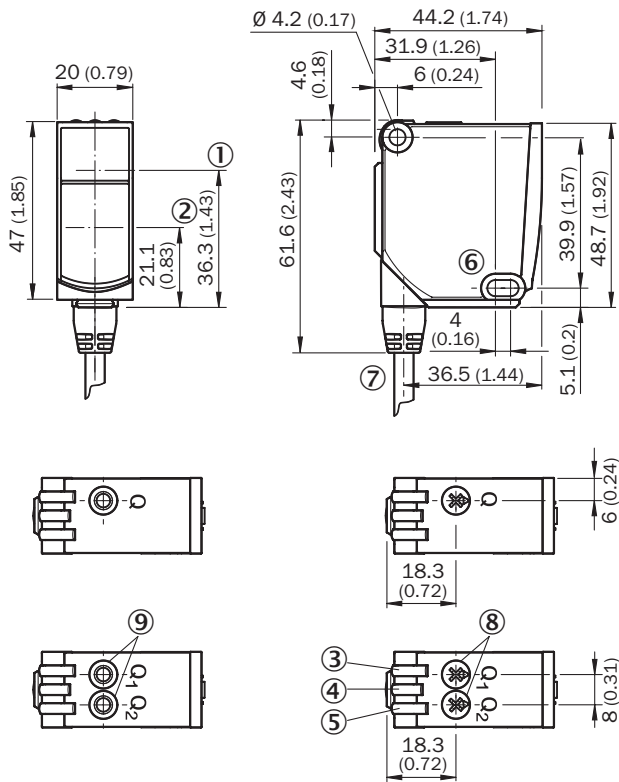

- ① Optical axis, sender
- ② Optical axis, receiver
- ③ LED indicator yellow: Status of received light beam
- ④ LED indicator green: power on
- ⑤ LED indicator yellow: Status of received light beam
- ⑥ Mounting hole,  $\varnothing 4.2$  mm
- ⑦ Connection
- ⑧ Potentiometer
- ⑨ Single teach-in button

**Connection diagram**

Cd-284

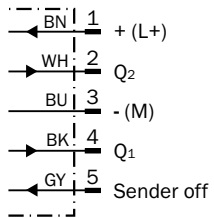

### Characteristic curve

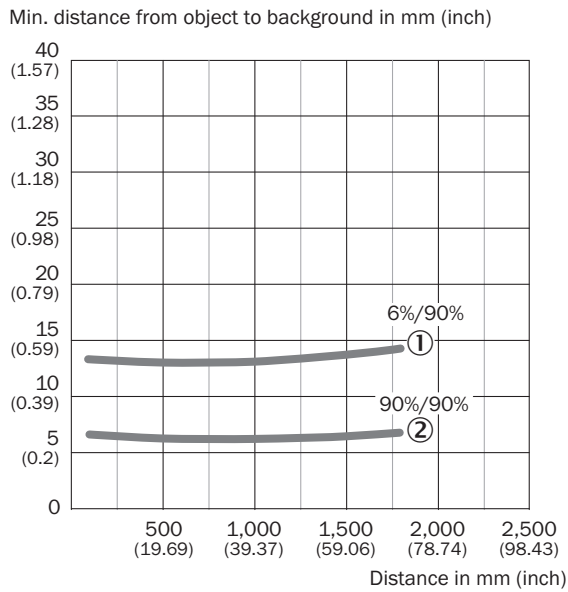

- ① Sensing range on black, 6% remission factor
- ② Sensing range on white, 90% remission factor

### Light spot size

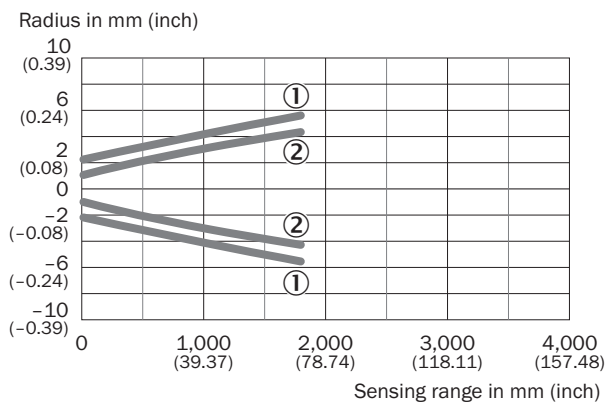

- ① Light spot horizontal
- ② Light spot vertical

## Repeatability

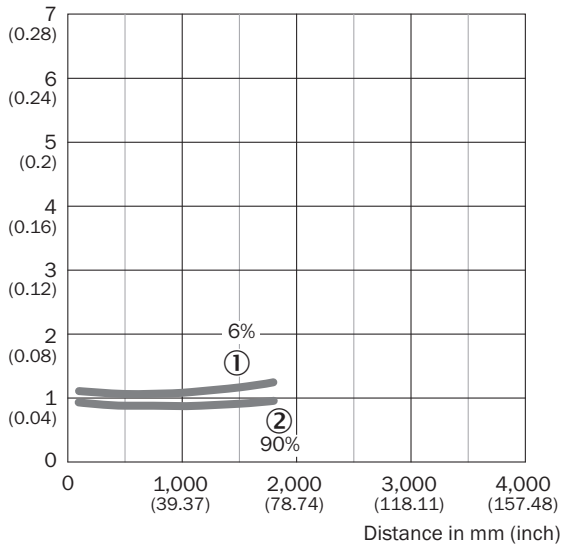

Repeatability in mm (inch)



- ① 6 % remission, on black
- ② 90 % remission, on white

## Recommended accessories

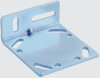
Other models and accessories → [www.sick.com/PowerProx](http://www.sick.com/PowerProx)

	Brief description	Type	Part no.
<b>Mounting brackets and plates</b>			
	Mounting brackets	BEF-WTT12L	2078538
<b>Plug connectors and cables</b>			
	Head A: female connector, M12, 5-pin, straight, A-coded Head B: Flying leads Cable: Sensor/actuator cable, PVC, unshielded, 5 m	YF2A15-050VB5XLEAX	2096240
	Head A: male connector, M12, 5-pin, straight Cable: unshielded For field bus technology	STE-1205-G	6022083

## SICK AT A GLANCE

SICK is one of the leading manufacturers of intelligent sensors and sensor solutions for industrial applications. A unique range of products and services creates the perfect basis for controlling processes securely and efficiently, protecting individuals from accidents and preventing damage to the environment.

We have extensive experience in a wide range of industries and understand their processes and requirements. With intelligent sensors, we can deliver exactly what our customers need. In application centers in Europe, Asia and North America, system solutions are tested and optimized in accordance with customer specifications. All this makes us a reliable supplier and development partner.

Comprehensive services complete our offering: SICK LifeTime Services provide support throughout the machine life cycle and ensure safety and productivity.

For us, that is “Sensor Intelligence.”

## WORLDWIDE PRESENCE:

Contacts and other locations –[www.sick.com](http://www.sick.com)