



Product designation	Power contactor		
Product type designation	BF26		
Contact characteristics			
Number of poles	Nr.	4	
Rated insulation voltage U _i IEC/EN	V	690	
Rated impulse withstand voltage U _{imp}	kV	6	
Operational frequency	min	Hz	25
	max	Hz	400
IEC Conventional free air thermal current I _{th}	A	45	
Operational current I _e	AC-1 (≤40°C)	A	45
	AC-1 (≤55°C)	A	36
	AC-1 (≤70°C)	A	32
	AC-3 (≤440V ≤55°C)	A	26
	AC-4 (400V)	A	11.5
Rated operational power AC-1 (T≤40°C)	230V	kW	17
	400V	kW	30
	500V	kW	37
	690V	kW	51
Short-time allowable current for 10s (IEC/EN60947-1)	A	210	
Protection fuse	gG (IEC)	A	50
	aM (IEC)	A	32
Making capacity (RMS value)	A	260	
Breaking capacity at voltage	440V	A	208
	500V	A	184
	690V	A	168
Resistance per pole (average value)	mΩ	2	
Power dissipation per pole (average value)	I _{th}	W	4
	AC-3	W	1.4
Tightening torque for terminals	min	Nm	2.5
	max	Nm	3
	min	lbin	1.8
	max	lbin	2.2
Tightening torque for coil terminal	min	Nm	0.8
	max	Nm	1
	min	lbin	0.8
	max	lbin	0.74
Max number of wires simultaneously connectable	Nr.	2	

Conductor section			
AWG/Kcmil		max	6
Flexible w/o lug conductor section			
		min	mm ² 2.5
		max	mm ² 16
Flexible c/w lug conductor section			
		min	mm ² 1
		max	mm ² 10
Flexible with insulated spade lug conductor section			
		min	mm ² 1
		max	mm ² 10
Power terminal protection according to IEC/EN 60529			IP20 when properly wired
Mechanical features			
Operating position			
		normal allowable	Vertical plan ±30°
Fixing			Screw / DIN rail 35mm
Weight			g 665
Conductor section			
AWG/kcmil conductor section		max	6
Operations			
Mechanical life		cycles	20000000
Electrical life		cycles	1600000
Safety related data			
Performance level B10d according to EN/ISO 13489-1			
		rated load	cycles 1600000
		mechanical load	cycles 20000000
Mirror contacts according to IEC/EN 60947-4-1			YES
EMC compatibility			yes
DC coil operating			
DC rated control voltage		V	60
DC operating voltage			
pick-up		min	%Us 80
		max	%Us 125
drop-out		min	%Us 10
		max	%Us 40
Average coil consumption ≤20°C			
		in-rush	W 5.4
		holding	W 5.4
Max cycles frequency			
Mechanical operation		cycles/h	3600
Operating times			
Average time for Us control			
in AC		Closing NO	
		min	ms 8
		max	ms 24

Opening NO	min	ms	5
	max	ms	15
Closing NC	min	ms	9
	max	ms	20
Opening NC	min	ms	9
	max	ms	17
<hr/>			
Closing NC	min	ms	23
	max	ms	28
Opening NC	min	ms	46
	max	ms	56

in DC

UL technical data

Full-load current (FLA) for three-phase AC motor

at 480V	A	21
at 600V	A	22

Yielded mechanical performance

for single-phase AC motor

110/120V	HP	2
230V	HP	5

for three-phase AC motor

200/208V	HP	7.5
220/230V	HP	7.5
460/480V	HP	15
575/600V	HP	20

General USE

Contactor

AC current	A	45
------------	---	----

Ambient conditions

Temperature

Operating temperature

min	°C	-50
max	°C	70

Storage temperature

min	°C	-60
max	°C	80

Max altitude

m	3000
---	------

Resistance & Protection

Pollution degree

3

Dimensions

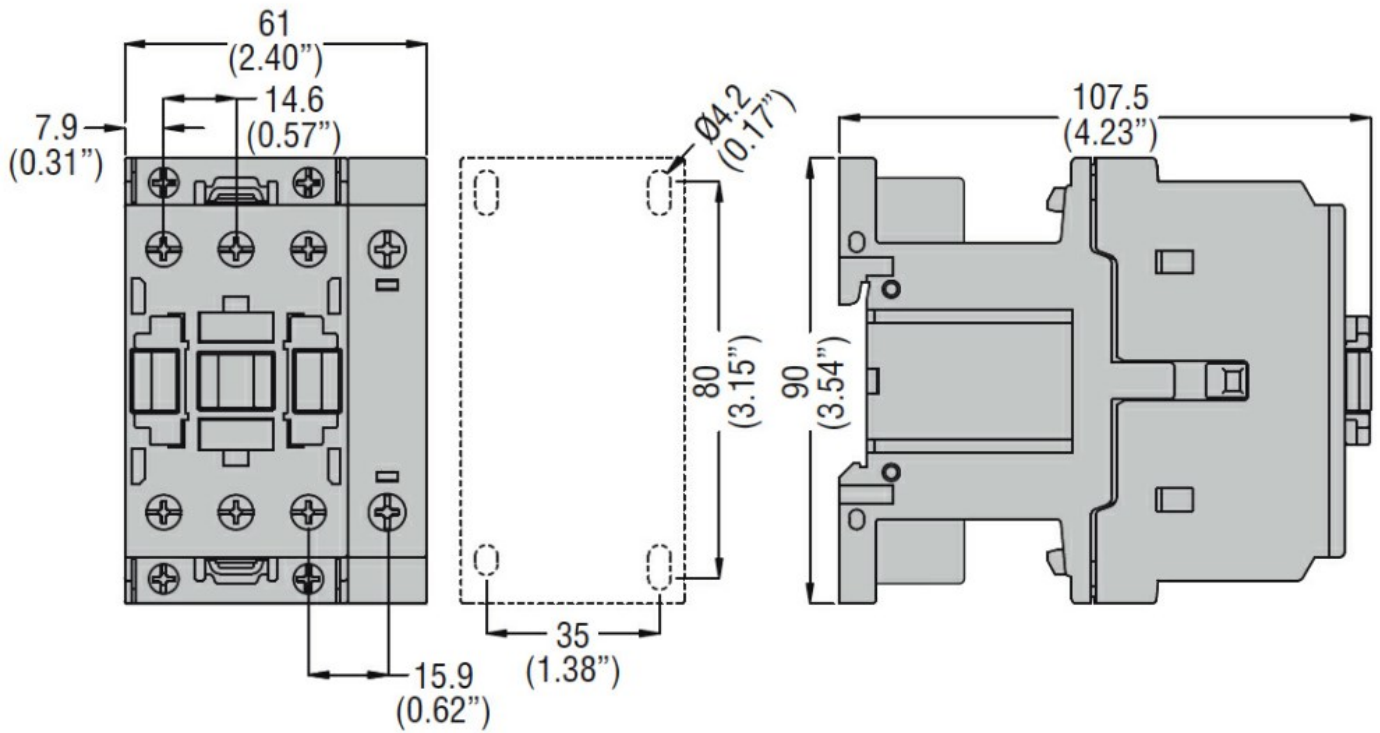

Wiring diagrams

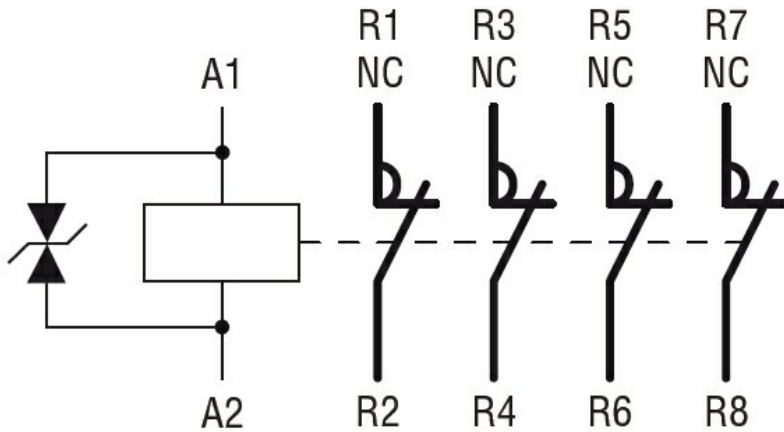

Certifications and compliance

Compliance

CSA C22.2 n° 60947-1

CSA C22.2 n° 60947-4-1

IEC/EN/BS 60947-1

IEC/EN/BS 60947-4-1

UL 60947-1

UL 60947-4-1

Certificates

CCC

cULus

EAC

ETIM classification

ETIM 8.0

EC000066 -
Power contactor,
AC switching