



# DL100-11HA2112

Dx100

LONG RANGE DISTANCE SENSORS

**SICK**  
Sensor Intelligence.



Illustration may differ



## Ordering information

Type	Part no.
DL100-11HA2112	1060046

Please ensure that the correct GSD file is used for successor products.

Available online under Downloads/Software.

Valid for -xxx2213 variants.

Other models and accessories → [www.sick.com/Dx100](http://www.sick.com/Dx100)

## Detailed technical data

### Mechanics/electronics

<b>Supply voltage <math>V_s</math></b>	DC 18 V ... 30 V, limit values
<b>Ripple</b>	5 V <sub>pp</sub> <sup>1)</sup>
<b>Initialization time</b>	Typ. 1.5 s <sup>2)</sup>
<b>Housing material</b>	Metal (Aluminum die cast)
<b>Window material</b>	Plastic (PMMA)
<b>Connection type</b>	Male connector, M12, SPEEDCON™ compatible
<b>Indication</b>	6 digit 5 x 7 dot matrix display, LEDs
<b>Weight</b>	Approx. 800 g (with mounting bracket: approx. 1,600 g)
<b>Current consumption</b>	At 24 V DC < 1,000 mA
<b>Dimensions (W x H x D)</b>	69.4 mm x 82.5 mm x 100.2 mm
<b>Modulation frequency</b>	Fix
<b>Enclosure rating</b>	IP65
<b>Protection class</b>	III

<sup>1)</sup> May not fall short of or exceed  $V_s$  tolerances.

<sup>2)</sup> After loss of reflector < 40 ms.

### Safety-related parameters

<b>MTTF<sub>D</sub></b>	101 years
<b>DC<sub>avg</sub></b>	0%

### Performance

<b>Measurement range min ... max:</b>	0.15 m ... 60 m, on "diamond grade" reflective tape
<b>Target</b>	Reflector
<b>Resolution</b>	0.1 mm, 0.125 mm, 1 mm, 10 mm, 100 mm
<b>Repeatability</b>	1.5 mm, at dead time 10 ms <sup>1)</sup>

<sup>1)</sup> Statistical error 1  $\sigma$ , environmental conditions constant, depending on operating mode.

<sup>2)</sup> From 150 mm ... 180 mm measuring range the accuracy can reach  $\pm 4$  mm.

<sup>3)</sup> Average service life: 100,000 h at  $T_U = +25$  °C.

	0.75 mm, at dead time 30 ms <sup>1)</sup>
<b>Accuracy</b>	± 3 mm <sup>2)</sup>
<b>Response time</b>	2 ms
<b>Measurement cycle time</b>	1 ms
<b>Output time</b>	1 ms
<b>Light source</b>	Laser, red <sup>3)</sup> visible red light
<b>Laser class</b>	2, complies with 21 CFR 1040.10 and 1040.11 except for the conformance according to "Laser Notice No. 50" from June 24, 2007 (IEC 60825-1:2014, EN 60825-1:2014)
<b>Typ. light spot size (distance)</b>	5 mm + (2 mm x distance in m)
<b>Max. movement speed</b>	10 m/s
<b>Heating</b>	✓

<sup>1)</sup> Statistical error 1  $\sigma$ , environmental conditions constant, depending on operating mode.

<sup>2)</sup> From 150 mm ... 180 mm measuring range the accuracy can reach ± 4 mm.

<sup>3)</sup> Average service life: 100,000 h at T<sub>U</sub> = +25 °C.

## Interfaces

<b>PROFINET</b>	✓
<b>Digital output</b>	
Number	2 <sup>1)</sup>
Type	Push-pull: PNP/NPN
Function	Distance: Distance switching output Speed: Speed output Service: Warning message as the sensor ages, if the damping value is exceeded (for example when contaminated, if the permitted interior device temperature is exceeded or undercut, if the measured value has a plausibility error, if the laser is not ready for operation, if the heating is switched on Laser off Preset
Maximum output current I <sub>A</sub>	≤ 100 mA <sup>2)</sup>
<b>Multifunctional input (MF)</b>	1 x MF1 <sup>3)</sup>

<sup>1)</sup> HIGH = > V<sub>S</sub> - 3 V / LOW = < 2 V.

<sup>2)</sup> Max. 100 nF/20 mH.

<sup>3)</sup> HIGH > 12 V / LOW < 3 V.

## Ambient data

<b>Electromagnetic compatibility (EMC)</b>	EN 61000-6-2, EN 61000-6-4 <sup>1)</sup>
<b>Ambient temperature, operation</b>	-40 °C ... +55 °C, operation with heating <sup>2)</sup> -40 °C ... +75 °C, operation with cooling case
<b>Ambient temperature, storage</b>	-40 °C ... +75 °C
<b>Effect of air pressure</b>	0.3 ppm/hPa
<b>Effect of air temperature</b>	1 ppm/K
<b>Temperature drift</b>	Typ. 0.1 mm/K
<b>Typ. Ambient light immunity</b>	≤ 100,000 lx
<b>Mechanical load</b>	Shock: (EN 600 68-2-27) Sine: (EN 600 68-2-6)

<sup>1)</sup> This is a Class A device. This device can cause radio interference in living quarters.

<sup>2)</sup> Temperatures < -10 °C require warm-up time of typ. 7 minutes.

Noise: (EN 600 68-2-64)

1) This is a Class A device. This device can cause radio interference in living quarters.

2) Temperatures < -10 °C require warm-up time of typ. 7 minutes.

## Classifications

<b>ECLASS 5.0</b>	27270801
<b>ECLASS 5.1.4</b>	27270801
<b>ECLASS 6.0</b>	27270801
<b>ECLASS 6.2</b>	27270801
<b>ECLASS 7.0</b>	27270801
<b>ECLASS 8.0</b>	27270801
<b>ECLASS 8.1</b>	27270801
<b>ECLASS 9.0</b>	27270801
<b>ECLASS 10.0</b>	27270801
<b>ECLASS 11.0</b>	27270801
<b>ECLASS 12.0</b>	27270916
<b>ETIM 5.0</b>	EC001825
<b>ETIM 6.0</b>	EC001825
<b>ETIM 7.0</b>	EC001825
<b>ETIM 8.0</b>	EC001825
<b>UNSPSC 16.0901</b>	41111613

**Dimensional drawing** (Dimensions in mm (inch))

Dimensional drawing

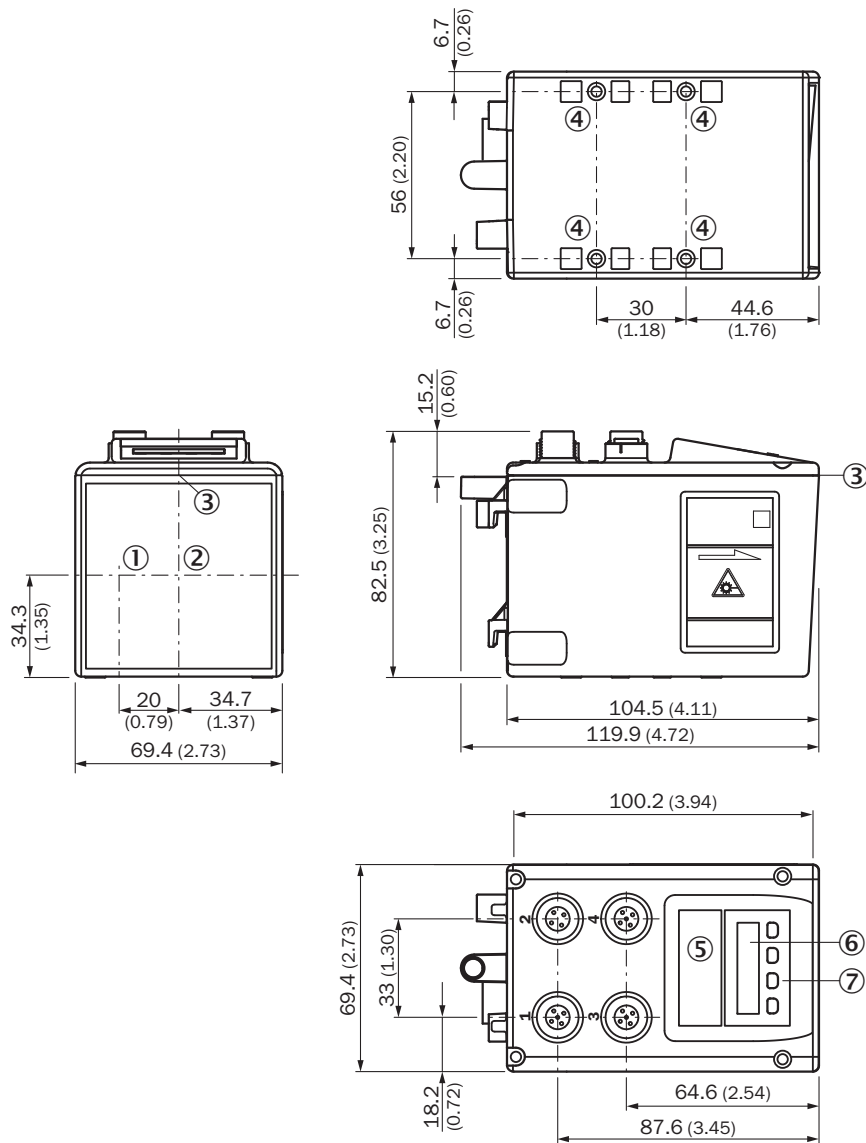

- ① Optical axis, sender
- ② Optical axis, receiver
- ③ Zero level
- ④ Threaded mounting hole M5
- ⑤ Status LED [status]
- ⑥ Display
- ⑦ Control elements

**Connection type**

Ethernet connection type

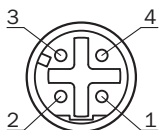

Voltage supply connection type

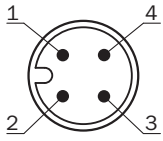

PROFINET port 1, port 2 connection type

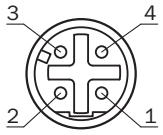

### Connection diagram

Ethernet connection diagram

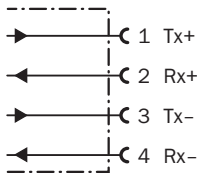

### Adjustment possible



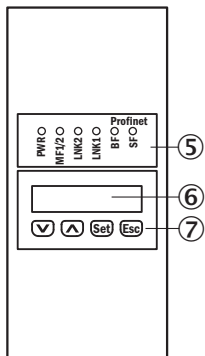

DL100-xxxxxx12



- ⑤ Status LED [status]
- ⑥ Display
- ⑦ Control elements

## Recommended accessories

Other models and accessories → [www.sick.com/Dx100](http://www.sick.com/Dx100)

	Brief description	Type	Part no.
Plug connectors and cables			
	<ul style="list-style-type: none"> <li><b>Connection type head A:</b> Female connector, M12, 4-pin, straight, A-coded</li> <li><b>Connection type head B:</b> Flying leads</li> <li><b>Signal type:</b> Sensor/actuator cable</li> <li><b>Cable:</b> 2 m, 4-wire, PVC</li> <li><b>Description:</b> Sensor/actuator cable, unshielded</li> <li><b>Application:</b> Zones with chemicals</li> </ul>	YF2A14-020VB3XLEAX	2096234
	<ul style="list-style-type: none"> <li><b>Connection type head A:</b> Female connector, M12, 4-pin, straight, A-coded</li> <li><b>Connection type head B:</b> Flying leads</li> <li><b>Signal type:</b> Sensor/actuator cable</li> <li><b>Cable:</b> 5 m, 4-wire, PVC</li> <li><b>Description:</b> Sensor/actuator cable, unshielded</li> <li><b>Application:</b> Zones with chemicals</li> </ul>	YF2A14-050VB3XLEAX	2096235
	<ul style="list-style-type: none"> <li><b>Connection type head A:</b> Female connector, M12, 4-pin, straight, A-coded</li> <li><b>Connection type head B:</b> Flying leads</li> <li><b>Signal type:</b> Sensor/actuator cable</li> <li><b>Cable:</b> 10 m, 4-wire, PVC</li> <li><b>Description:</b> Sensor/actuator cable, unshielded</li> <li><b>Application:</b> Zones with chemicals</li> </ul>	YF2A14-100VB3XLEAX	2096236
	<ul style="list-style-type: none"> <li><b>Connection type head A:</b> Male connector, M12, 4-pin, straight, D-coded</li> <li><b>Connection type head B:</b> Flying leads</li> <li><b>Signal type:</b> Ethernet, PROFINET</li> <li><b>Cable:</b> 2 m, 4-wire, PUR, halogen-free</li> <li><b>Description:</b> Ethernet, shieldedPROFINET</li> <li><b>Application:</b> Drag chain operation, Zones with oils and lubricants</li> </ul>	YM2D24-020PN1XLEAX	2106171
	<ul style="list-style-type: none"> <li><b>Connection type head A:</b> Male connector, M12, 4-pin, straight, D-coded</li> <li><b>Connection type head B:</b> Flying leads</li> <li><b>Signal type:</b> Ethernet, PROFINET</li> <li><b>Cable:</b> 5 m, 4-wire, PUR, halogen-free</li> <li><b>Description:</b> Ethernet, shieldedPROFINET</li> <li><b>Application:</b> Drag chain operation, Zones with oils and lubricants</li> </ul>	YM2D24-050PN1XLEAX	2106172
	<ul style="list-style-type: none"> <li><b>Connection type head A:</b> Male connector, M12, 4-pin, straight, D-coded</li> <li><b>Connection type head B:</b> Flying leads</li> <li><b>Signal type:</b> Ethernet, PROFINET</li> <li><b>Cable:</b> 10 m, 4-wire, PUR, halogen-free</li> <li><b>Description:</b> Ethernet, shieldedPROFINET</li> <li><b>Application:</b> Drag chain operation, Zones with oils and lubricants</li> </ul>	YM2D24-100PN1XLEAX	2106173
Reflectors			
	Reflector plate, "diamond grade" reflective tape, 330 mm x 330 mm, base plate material: aluminum, screw connection, Screw-on, 4 hole mounting	PL240DG	1017910
	Reflector plate, "diamond grade" reflective tape, 665 mm x 665 mm, base plate material: aluminum, screw connection, Screw-on, 4 hole mounting	PL560DG	1016806
Terminal and alignment brackets			
	Alignment unit for Dx100, incl. mounting material, steel, zinc coated	BEF-AH-DX100	2058653

## SICK AT A GLANCE

SICK is one of the leading manufacturers of intelligent sensors and sensor solutions for industrial applications. A unique range of products and services creates the perfect basis for controlling processes securely and efficiently, protecting individuals from accidents and preventing damage to the environment.

We have extensive experience in a wide range of industries and understand their processes and requirements. With intelligent sensors, we can deliver exactly what our customers need. In application centers in Europe, Asia and North America, system solutions are tested and optimized in accordance with customer specifications. All this makes us a reliable supplier and development partner.

Comprehensive services complete our offering: SICK LifeTime Services provide support throughout the machine life cycle and ensure safety and productivity.

For us, that is “Sensor Intelligence.”

## WORLDWIDE PRESENCE:

Contacts and other locations –[www.sick.com](http://www.sick.com)