



IPG2-2320A5P167

SICK
Sensor Intelligence.



Ordering information

Type	Part no.
IPG2-2320A5P167	2082189

Other models and accessories → www.sick.com/



Detailed technical data

Technical specifications

Accessory group	Device protection (mechanical)
Accessory family	Protective housings and protective pipes
Suitable for	Protective pipe for MLG-2, monitoring height 2,200 mm ... 2,245 mm
Material	PMMA (protective pipes), Aluminum (end caps, spacer), ABS-plastic (support holder), Polyamide (cable gland)
Color	Transparent
Dimensions (W x H x L)	50 mm x 50 mm x 2,320 mm ¹⁾
Description	Enclosure rating: IP 67; ambient temperature from ... to: -20 °C ... +55 °C

¹⁾ Visible protective pipe (PMMA).

Classifications

eCl@ss 5.0	27279202
eCl@ss 5.1.4	27279202
eCl@ss 6.0	27279202
eCl@ss 6.2	27279202
eCl@ss 7.0	27279202
eCl@ss 8.0	27279202
eCl@ss 8.1	27279202
eCl@ss 9.0	27273701
eCl@ss 10.0	27273701
eCl@ss 11.0	27273701
eCl@ss 12.0	27273701
ETIM 5.0	EC002615
ETIM 6.0	EC002615
ETIM 7.0	EC002615
ETIM 8.0	EC002615
UNSPSC 16.0901	32131023

Dimensional drawing (Dimensions in mm (inch))

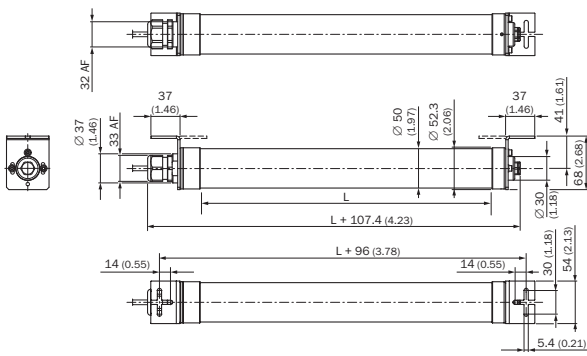

Monitoring height (L) mm	Protection pipe (L) mm	Monitoring height (L) mm	Protection pipe (L) mm	Monitoring height (L) mm	Protection pipe (L) mm
100 ... 145	220	1,000 ... 1,045	1,120	1,900 ... 1,945	2,020
250 ... 295	370	1,150 ... 1,195	1,270	2,050 ... 2,095	2,170
400 ... 445	520	1,300 ... 1,345	1,420	2,200 ... 2,245	2,320
550 ... 595	670	1,450 ... 1,495	1,570	2,350 ... 2,395	2,470
700 ... 745	820	1,600 ... 1,645	1,720	2,500 ... 2,545	2,620
850 ... 895	970	1,750 ... 1,795	1,870	2,650 ... 2,695	2,770
				2,800 ... 2,845	2,920

SICK AT A GLANCE

SICK is one of the leading manufacturers of intelligent sensors and sensor solutions for industrial applications. A unique range of products and services creates the perfect basis for controlling processes securely and efficiently, protecting individuals from accidents and preventing damage to the environment.

We have extensive experience in a wide range of industries and understand their processes and requirements. With intelligent sensors, we can deliver exactly what our customers need. In application centers in Europe, Asia and North America, system solutions are tested and optimized in accordance with customer specifications. All this makes us a reliable supplier and development partner.

Comprehensive services complete our offering: SICK LifeTime Services provide support throughout the machine life cycle and ensure safety and productivity.

For us, that is “Sensor Intelligence.”

WORLDWIDE PRESENCE:

Contacts and other locations –www.sick.com