

1SNA113542R1000 ✓ ACTIVE

ENTRELEC | ENTRELEC SNA

TE Internal #: 1SNA113542R1000

Terminal Block & Strip Conducting Accessories, Jumper Bar, 2

Pole, Gray, ENTRELEC SNA

[View on TE.com >](#)



Connectors > Terminal Blocks & Strips > Terminal Block & Strip Accessories > Terminal Block & Strip Conducting Accessories

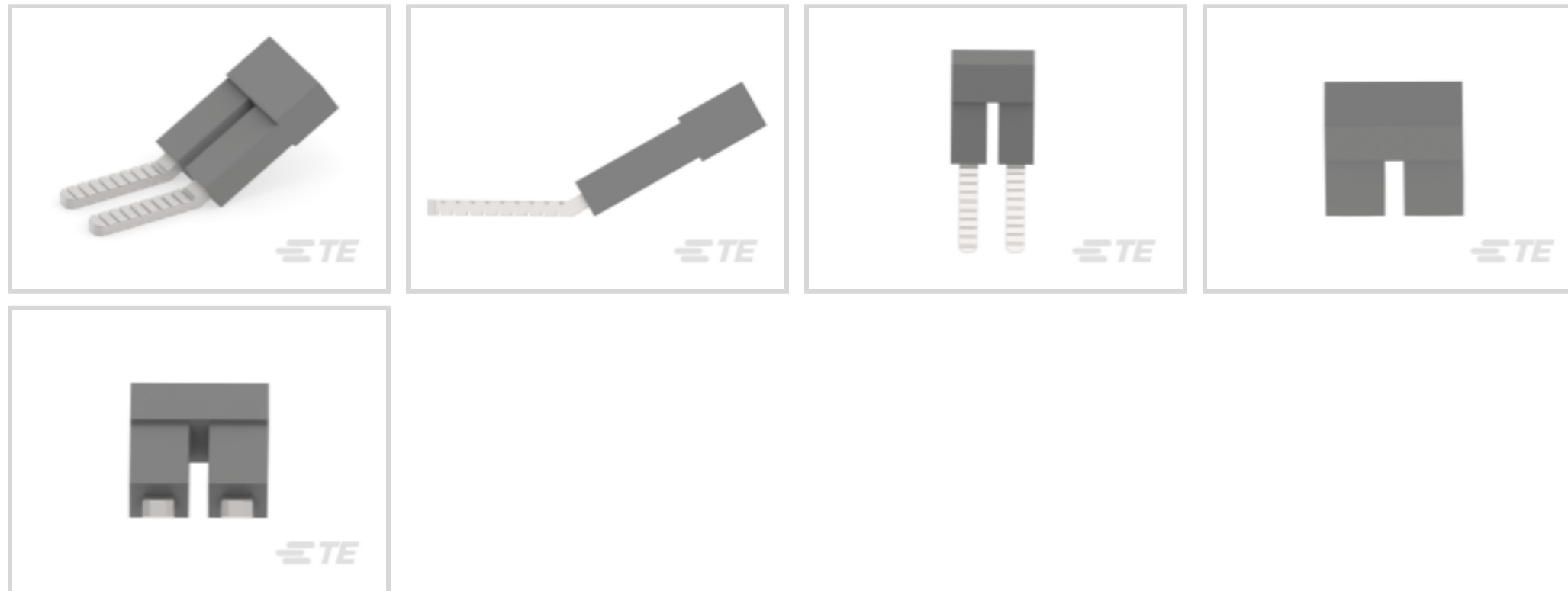

Conducting Accessory Type: **Jumper Bar**

Number of Poles: **2**

Primary Product Color: **Gray**

Contact Current Rating (Max): **30 A**

## Features

### Product Type Features

Conducting Accessory Type	Jumper Bar
---------------------------	------------

### Configuration Features

Number of Poles	2
-----------------	---

### Body Features

Primary Product Color	Gray
-----------------------	------

### Contact Features

Contact Current Rating (Max)	30 A
------------------------------	------

## Product Compliance

[For compliance documentation, visit the product page on TE.com>](#)

EU RoHS Directive 2011/65/EU	Compliant
EU ELV Directive 2000/53/EC	Compliant
China RoHS 2 Directive MIIT Order No 32, 2016	No Restricted Materials Above Threshold
EU REACH Regulation (EC) No. 1907/2006	Current ECHA Candidate List: JUNE 2022 (224)



Candidate List Declared Against: JUNE 2022 (224)

Does not contain REACH SVHC

Halogen Content

Low Halogen - Br, Cl, F, I < 900 ppm per homogenous material. Also BFR/CFR/PVC Free

Solder Process Capability

Not reviewed for solder process capability

Product Compliance Disclaimer

This information is provided based on reasonable inquiry of our suppliers and represents our current actual knowledge based on the information they provided. This information is subject to change. The part numbers that TE has identified as EU RoHS compliant have a maximum concentration of 0.1% by weight in homogenous materials for lead, hexavalent chromium, mercury, PBB, PBDE, DBP, BBP, DEHP, DIBP, and 0.01% for cadmium, or qualify for an exemption to these limits as defined in the Annexes of Directive 2011/65/EU (RoHS2). Finished electrical and electronic equipment products will be CE marked as required by Directive 2011/65/EU. Components may not be CE marked. Additionally, the part numbers that TE has identified as EU ELV compliant have a maximum concentration of 0.1% by weight in homogenous materials for lead, hexavalent chromium, and mercury, and 0.01% for cadmium, or qualify for an exemption to these limits as defined in the Annexes of Directive 2000/53/EC (ELV). Regarding the REACH Regulation, the information TE provides on SVHC in articles for this part number is based on the latest European Chemicals Agency (ECHA) 'Guidance on requirements for substances in articles' posted at this URL: <https://echa.europa.eu/guidance-documents/guidance-on-reach>

## Compatible Parts





Also in the Series | **ENTRELEC SNA**

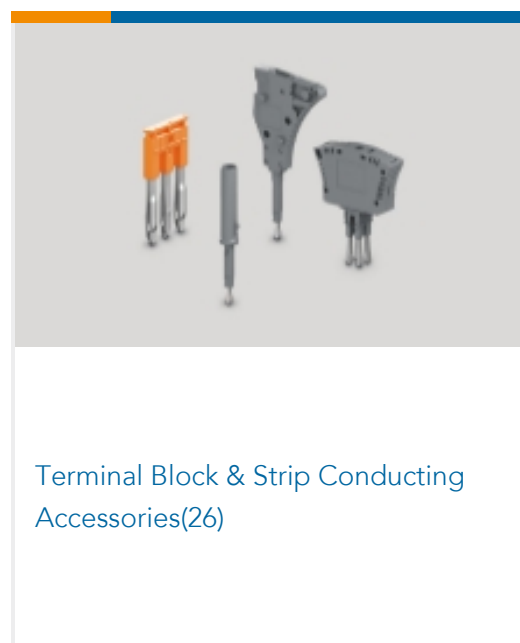

Customers Also Bought

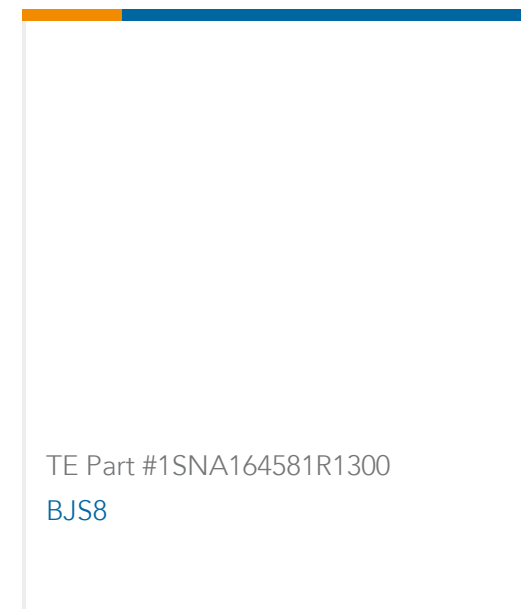
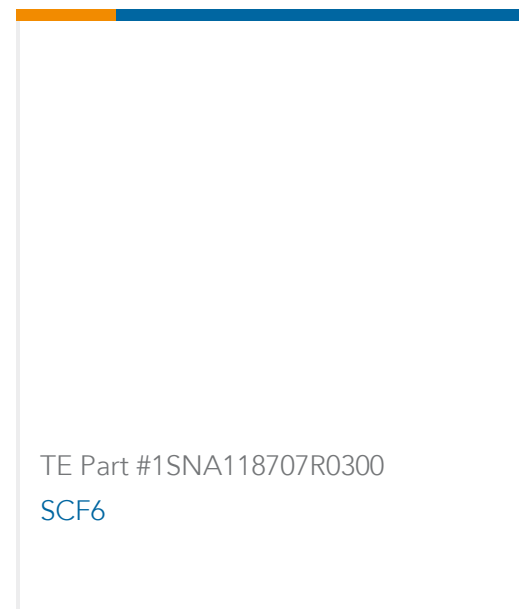
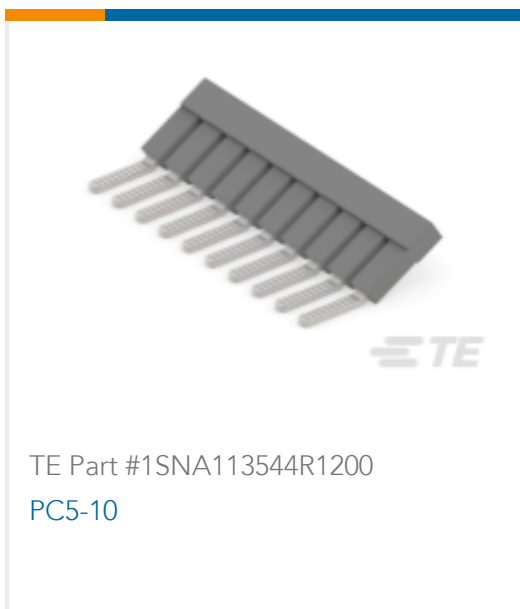

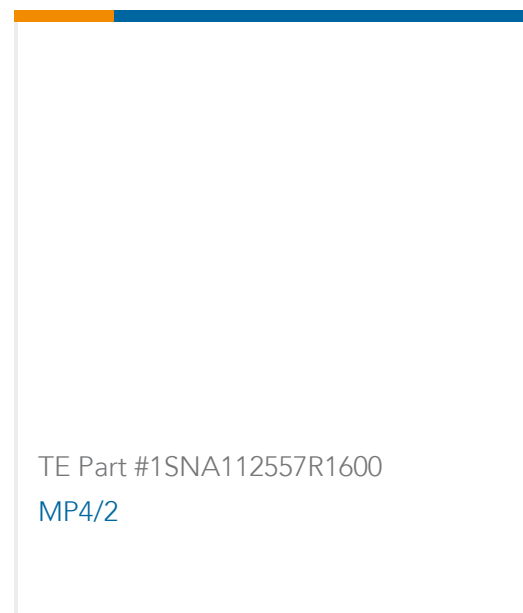
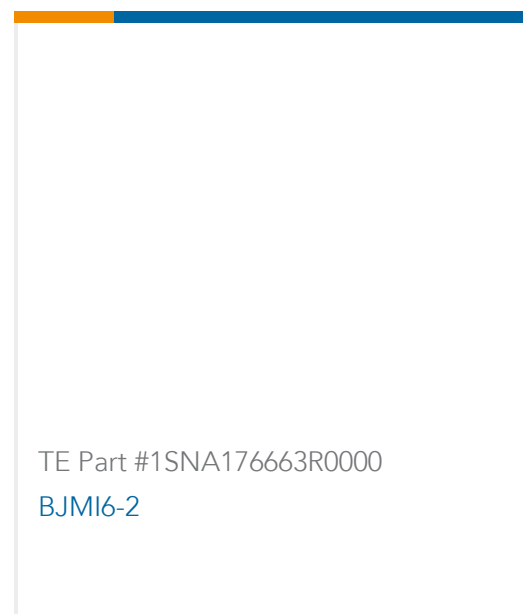
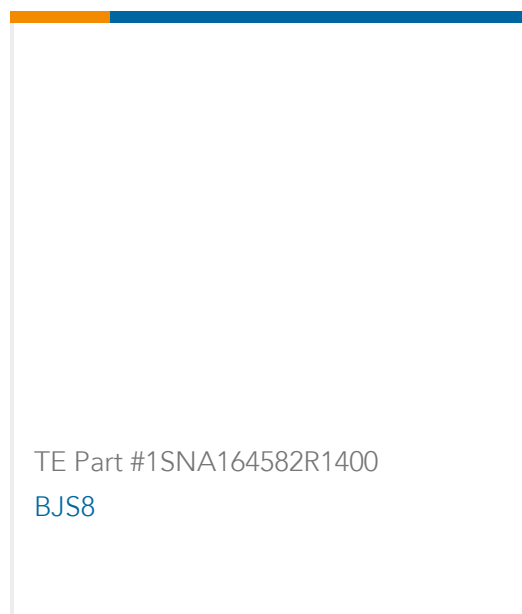

## Documents

### CAD Files

3D PDF

3D

Customer View Model

[ENG\\_CVM\\_CVM\\_1SNA113542R1000\\_A.2d\\_dxf.zip](#)

English

Customer View Model

[ENG\\_CVM\\_CVM\\_1SNA113542R1000\\_A.3d\\_igs.zip](#)

English

Customer View Model

[ENG\\_CVM\\_CVM\\_1SNA113542R1000\\_A.3d\\_stp.zip](#)

English

By downloading the CAD file I accept and agree to the [Terms and Conditions](#) of use.

### Datasheets & Catalog Pages

[Catalogue - ENTRELEC terminal-blocks-sna-series](#)

English

[PC5-2](#)

English

[ENTRELEC Terminal Block - Master Catalog](#)

English

[SNK SERIES TERMINAL BLOCKS](#)

English

[ENTRELEC Terminal Blocks Catalogue \(RUS\)](#)